



Quick Installation Guide

ISC-4110U/8110U

Industrial Serial Media Converter

Introduction

ISC-4110U/8110U series is High-Speed RS-232 serial port converter with compact size that connects to a PC USB port or USB Hub via the Universal Serial Bus(USB) port. The ISC-4110U/8110U features easy connectivity for traditional serial devices. The RS-232 standard supports full-duplex communication and handshaking signals (such as RTS, CTS, DSR, DTR). ISC-4110U/8110U also offers internal surge-protection on their data lines. Internal high-speed transient suppressors on each data line protect the modules from dangerous voltages levels or spikes. In addition, ISC-4110U/8110U can derive the power from USB port or redundant power inputs on terminal block or power jack. Therefore, ISC-4110U/8110U is one of the most reliable choices for USB to RS-232 media conversion application.

Features

- > Fully compliant with USB specification 2.0
- > Support Full-Duplex transmission
- > RS-232 support RTS/CTS, DSR/DTR handshake signals
- > Baud rate up to 921.6Kbps
- > USB bus powered with Ultra low power consumption
- > Dual redundant external DC power inputs on terminal block and power jack
- > Wide operating temperature range from -40°C to 70°C
- > Rigid IP-30 slim type housing design
- > DIN-Rail and panel mounting enabled

Specifications

ORing Serial Media Converter Model	ISC-4110U	ISC-8110U
Physical Ports		
USB 2.0 port	1	1
RS-232 Serial Port	4	8
Serial connector	DB9 connector (Male):By DB62 (Male) to 4xDB9 cable	DB9 connector (Male):By DB62 (Male) to 8xDB9 cable
Baud Rate	300 to 921.6Kbps	
RS-232 Signals	Tx, Rx, RTS, CTS, DTR, DSR, DCD, GND	
LED indicator		
Power indicator	Green: Power LED x 1	
Data transmission indicator	Green LED x 4	Green LED x 8
Power		
Input power	USB bus power (self power) or Dual DC inputs by 12-48 VDC on 2 pin terminal block and power jack	
Power consumption(Typ.)	1.6 Watts (320mA@5V USB Bus Power)	2 Watts (400mA@5V USB Bus Power)
Protection		
Serial port protection	Build-in 15KV ESD protection	
Drive Support		
Operation System	Windows 2000 (32bit), Windows 2003/XP/Vista/2008/7 (32/64 bit), Windows Mobile 5/6, PocketPC 2003 WinCE 4.2~5.2/6.0, Linux x86 (32/64bit)	
Physical Characteristic		
Enclosure	IP-30	
Dimension (W x D x H)	26.1 (W)mm x 95 (D)mm x 144.3 (H)mm (1.03x3.74x5.68 inch)	
Weight (g)	348 g	350 g
Environmental		
Storage Temperature	-40 to 85°C (-40 to 185°F)	
Operating Temperature	-40 to 70°C (-40 to 158°F)	
Operating Humidity	5% to 95% Non-condensing	
Regulatory approvals		
EMI	FCC Part 15, CISPR (EN55022) class A	
EMS	EN61000-4-2 (ESD), EN61000-4-3 (RS), EN61000-4-4 (EFT), EN61000-4-5 (Surge), EN61000-4-6 (CS), EN61000-4-8, EN61000-4-11	
Shock	IEC60068-2-27	
Free Fall	IEC60068-2-32	
Vibration	IEC60068-2-6	
Safety	EN60950-1	
Warranty	5 years	

Connections of Media Converter

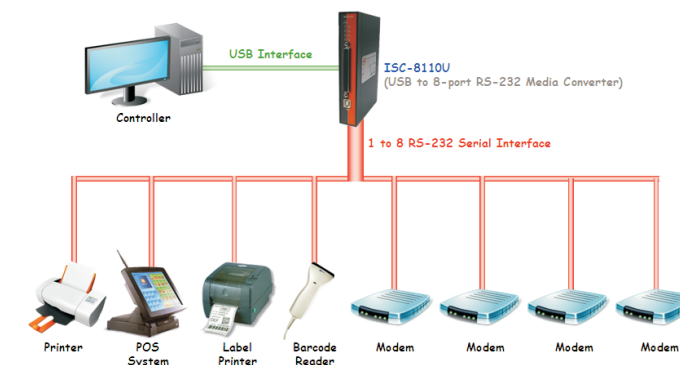
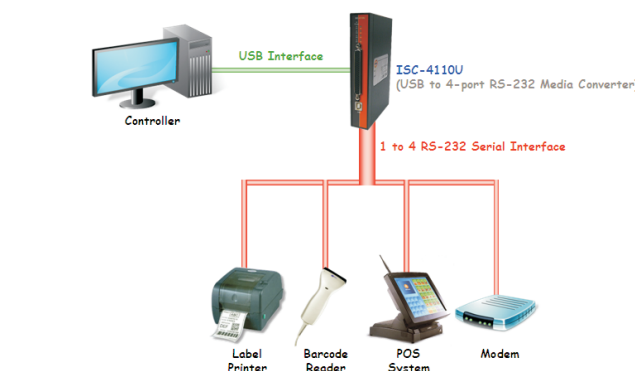

Pin Assignment

- RS-232 DB9 Male

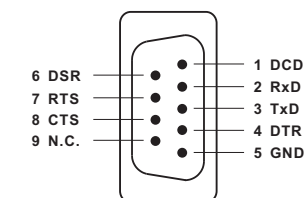

ORing Industrial Networking Corp.

Copyright© 2009 ORing
All rights reserved.TEL: +886-2-2918-3036 Website: www.oring-networking.com
FAX: +886-2-2918-3084 E-mail: support@oring-networking.com



Quick Installation Guide

ISC-4110U/8110U

Industrial Serial Media Converter

Installation

DIN-Rail Install Step

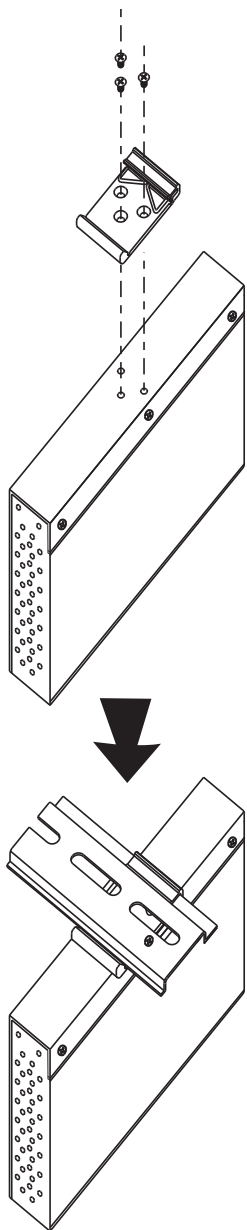

Wall-mounted Install Step

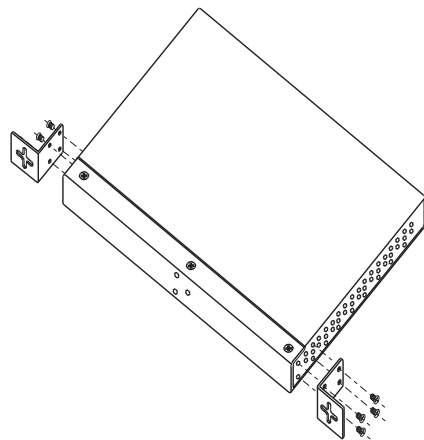

Front Panel

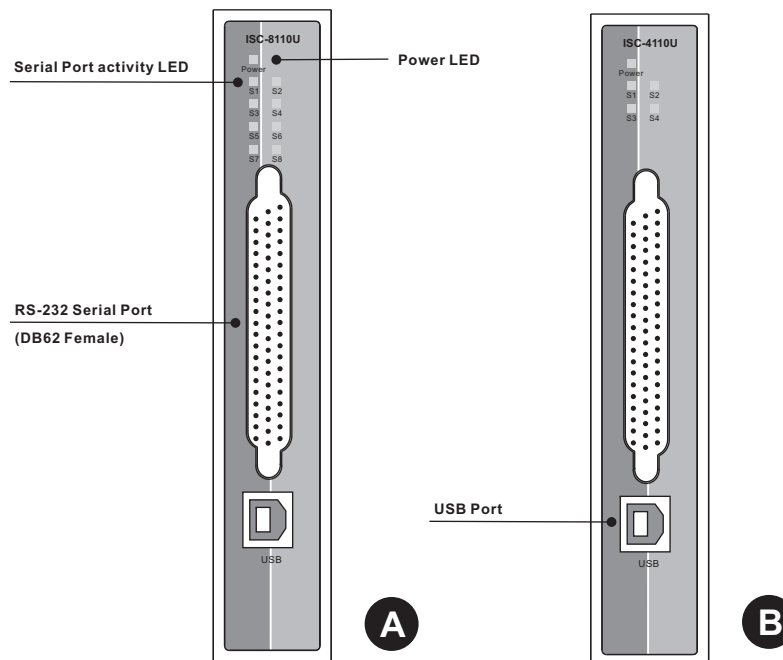

Accessory

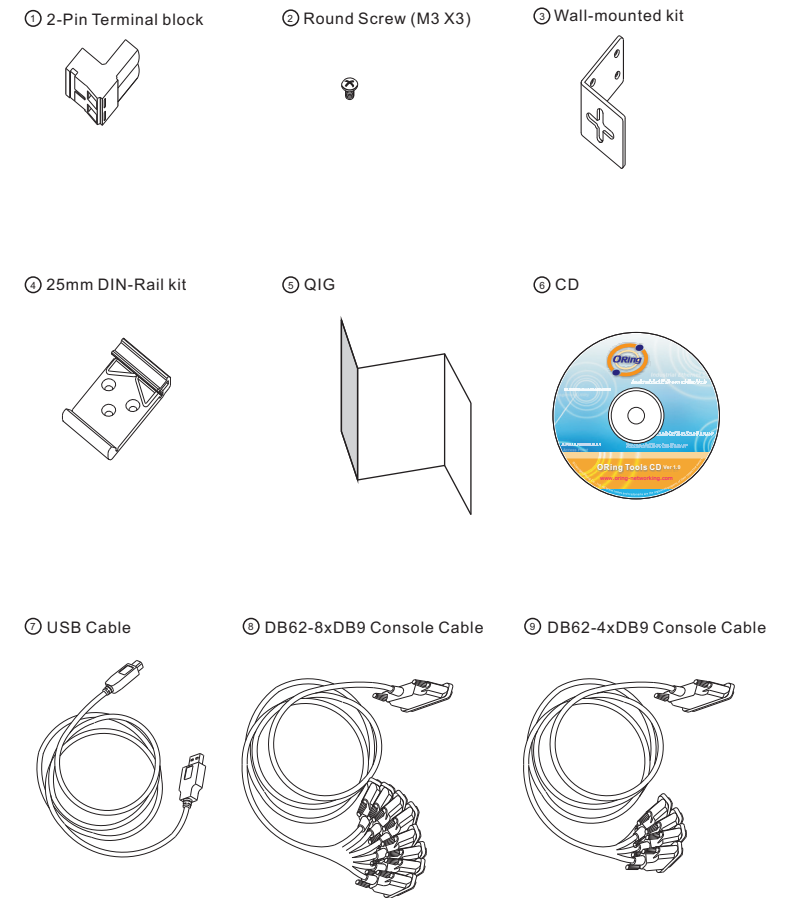

Power Connection Guide

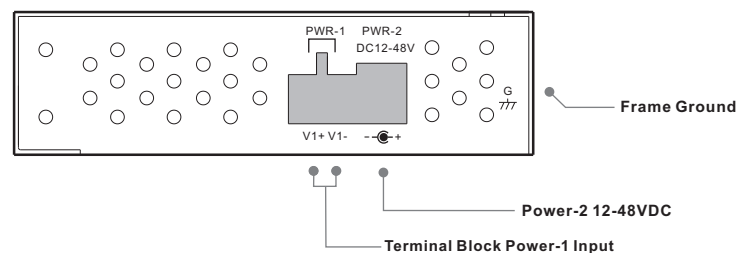

Packing list

Model name	Front Panel	Model Description	Accessory
ISC-8110U	A	Industrial 1-port USB to 8-port RS-232 serial media converter	⊗ X 1, ⊗ X 8, ⊗ X 2, ⊗ X 1, ⊗ X 1, ⊗ X 1, ⊗ X 1, ⊗ X 1
ISC-4110U	B	Industrial 1-port USB to 4-port RS-232 serial media converter	⊗ X 1, ⊗ X 8, ⊗ X 2, ⊗ X 1, ⊗ X 1, ⊗ X 1, ⊗ X 1, ⊗ X 1