

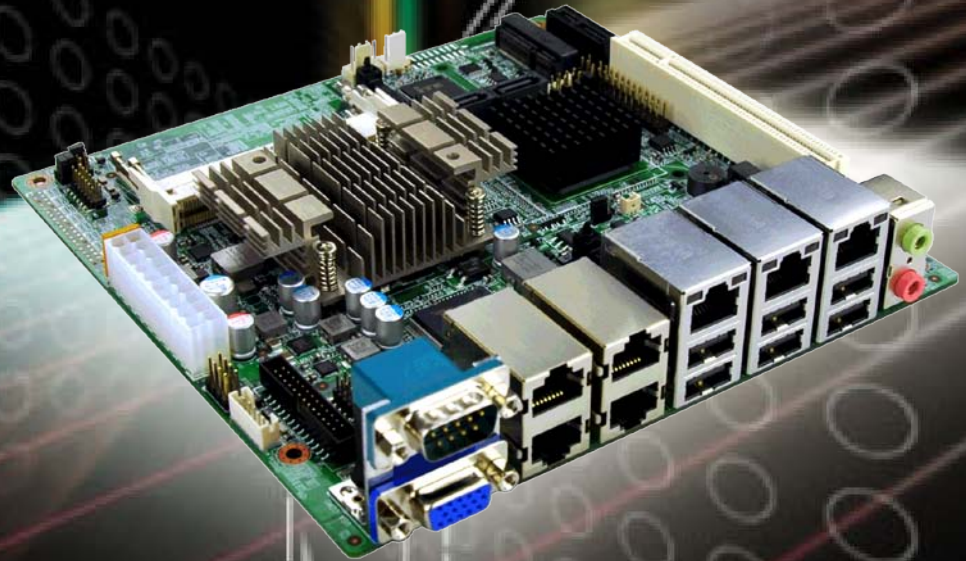

IEI Technology Corp.



MODEL:

KINO-PV-D5253-D4253

Mini-ITX Motherboard with Intel® Atom™ Processor D525 /D425, DDR3, VGA, LAN, SATA 3Gb/s, PCIe x1, USB, HD Audio, RoHS Compliant

User Manual

Rev. 1.02 – 7 February, 2012



Revision

Date	Version	Changes
7 February, 2012	1.02	Modify Section E.3. Assembly Language Example
7 February, 2012	1.01	Modify Motherboard's picture because V1.02 removed JCOM63, JCOM64, CN8, CN9 and IR1 connectors Modified Dimension in Figure 1-3.
7 February, 2012	1.00	Initial release

Copyright

COPYRIGHT NOTICE

The information in this document is subject to change without prior notice in order to improve reliability, design and function and does not represent a commitment on the part of the manufacturer.

In no event will the manufacturer be liable for direct, indirect, special, incidental, or consequential damages arising out of the use or inability to use the product or documentation, even if advised of the possibility of such damages.

This document contains proprietary information protected by copyright. All rights are reserved. No part of this manual may be reproduced by any mechanical, electronic, or other means in any form without prior written permission of the manufacturer.

TRADE MARKS

All registered trademarks and product names mentioned herein are used for identification purposes only and may be trademarks and/or registered trademarks of their respective owners.

Table of Contents

1 INTRODUCTION.....	1
1.1 INTRODUCTION.....	2
1.2 BENEFITS	2
1.3 FEATURES.....	3
1.4 CONNECTORS	3
1.5 DIMENSIONS.....	4
1.6 DATA FLOW	5
1.7 TECHNICAL SPECIFICATIONS	5
2 PACKING LIST	8
2.1 ANTI-STATIC PRECAUTIONS	9
2.2 UNPACKING PRECAUTIONS.....	9
2.3 PACKING LIST.....	10
2.4 OPTIONAL ITEMS	11
3 CONNECTORS	13
3.1 PERIPHERAL INTERFACE CONNECTORS.....	14
3.1.1 <i>Layout</i>	14
3.1.2 <i>Peripheral Interface Connectors</i>	14
3.1.3 <i>External Interface Panel Connectors</i>	15
3.2 INTERNAL PERIPHERAL CONNECTORS	16
3.2.1 <i>Battery Connector</i>	16
3.2.2 <i>CPU Fan Connector</i>	17
3.2.3 <i>System Fan Connector</i>	18
3.2.4 <i>Standard ATX power connector</i>	19
3.2.5 <i>Digital I/O Connector</i>	20
3.2.6 <i>Front Panel Connector</i>	21
3.2.7 <i>Memory Slot</i>	22
3.2.8 <i>Parallel Port Connector</i>	23
3.2.9 <i>RS-232/422/485 Serial Port Connector</i>	24
3.2.10 <i>SATA Drive Connectors</i>	26

KINO-PV-D5253-D4253 Mini-ITX Motherboard

3.2.11 SMBus Connector.....	27
3.2.12 SPI Flash Connector.....	28
3.2.13 USB Connectors.....	29
3.2.14 TPM Connector.....	29
3.2.15 Keyboard/Mouse Wafer.....	30
3.2.16 PCIe Mini Card Slot	31
3.3 EXTERNAL PERIPHERAL INTERFACE CONNECTOR PANEL	32
3.3.1 Audio Connector	33
3.3.2 LAN Connector	33
3.3.3 Serial Port Connectors (COM1).....	34
3.3.4 Serial Port Connectors (COM1_2, COM3_4).....	34
3.3.5 USB Connector	35
3.3.6 VGA Connector	35
4 INSTALLATION	37
4.1 ANTI-STATIC PRECAUTIONS	38
4.2 INSTALLATION CONSIDERATIONS.....	38
4.3 BASIC INSTALLATION	40
4.3.1 SO-DIMM Installation.....	40
4.3.2 Motherboard Installation.....	40
4.4 JUMPER SETTINGS	41
4.4.1 Clear CMOS Jumper.....	41
4.4.2 USB6, 7 power Jumper	42
4.4.3 COM 6 Function Select Jumper.....	43
4.5 INTERNAL PERIPHERAL DEVICE CONNECTIONS.....	44
4.5.1 SATA Drive Connection	44
4.5.2 Single RS-232 Cable (w/o Bracket)	46
4.6 EXTERNAL PERIPHERAL INTERFACE CONNECTION	47
4.6.1 Audio Connector	47
4.6.2 LAN Connection.....	48
4.6.3 Serial Device Connection	49
4.6.4 USB Device Connection.....	50
4.6.5 VGA Monitor Connection	51
4.7 SOFTWARE INSTALLATION	52
5 BIOS.....	53

5.1 INTRODUCTION.....	54
5.1.1 Starting Setup.....	54
5.1.2 Using Setup.....	54
5.1.3 Getting Help.....	55
5.1.4 Unable to Reboot after Configuration Changes.....	55
5.1.5 BIOS Menu Bar.....	55
5.2 MAIN.....	56
5.3 ADVANCED.....	57
5.3.1 ACPI Settings.....	57
5.3.2 Trusted Computing.....	58
5.3.3 CPU Configuration.....	59
5.3.4 SATA Configuration.....	61
5.3.5 USB Configuration.....	62
5.3.6 Super IO Configuration.....	63
5.3.6.1 Serial Port n Configuration.....	64
5.3.6.2 Parallel Port Configuration.....	69
5.3.7 H/W Monitor.....	70
5.3.8 Serial Port Console Redirection.....	71
5.4 CHIPSET.....	73
5.4.1 Host Bridge Configuration.....	74
5.4.2 South Bridge Configuration.....	75
5.4.3 Intel IGD SWSCI OpRegion.....	77
5.5 BOOT.....	78
5.6 SECURITY.....	79
5.7 SAVE&EXIT.....	81
A BIOS Options.....	83
B Terminology.....	86
C One Key Recovery.....	90
D Watchdog Timer.....	118
E Digital I/O Interface.....	121
F Hazardous Materials Disclosure.....	124

List of Figures

Figure 1-1: KINO-PV-D5253/D4253	2
Figure 1-2: Connectors	3
Figure 1-3: Dimensions (mm)	4
Figure 1-4: Data Flow Diagram	5
Figure 3-1: Connectors and Jumpers	14
Figure 3-2: Battery Connector Location	17
Figure 3-3: CPU Fan Connector Location	18
Figure 3-4: System Fan Connector Location	19
Figure 3-5: ATX Power Input Connector Location	20
Figure 3-6: Digital I/O Connector Locations	21
Figure 3-7: Front Panel Connector Location	22
Figure 3-8: Memory Card Slot Location	23
Figure 3-9: Parallel Port Connector Location	24
Figure 3-10: RS-232/422/485 Serial Port Connector	25
Figure 3-11: SATA Drive Connector Location	26
Figure 3-12: SMBus Connector Location	27
Figure 3-13: SPI Flash Connector	28
Figure 3-14: USB Connector Pinout Locations	29
Figure 3-15: TPM Connector	30
Figure 3-16: Keyboard/Mouse Connector Location	31
Figure 3-17: PCIe Mini Card Slot Location	32
Figure 3-18: External Peripheral Interface Connector	32
Figure 3-19: Audio Connector	33
Figure 3-20: Serial Port Pinouts	34
Figure 3-21: VGA Connector	36
Figure 4-1: SO-DIMM Installation	40
Figure 4-2: Clear BIOS Jumper Location	42
Figure 4-3: USB6, 7 power Jumper Location	43
Figure 4-4: COM 6 Function Select Jumper Location	44
Figure 4-5: SATA Drive Cable Connection	45

Figure 4-6: SATA Power Drive Connection	46
Figure 4-7: Single RS-232 Cable Installation	47
Figure 4-8: Audio Connector	48
Figure 4-9: LAN Connection	49
Figure 4-10: Serial Device Connector	50
Figure 4-11: USB Connector	51
Figure 4-12: VGA Connector	52
Figure C-1: IEI One Key Recovery Tool Menu	91
Figure C-2: Launching the Recovery Tool	95
Figure C-3: Recovery Tool Setup Menu	96
Figure C-4: Command Mode.....	96
Figure C-5: Partition Creation Commands.....	97
Figure C-6: Launching the Recovery Tool	99
Figure C-7: System Configuration for Windows	99
Figure C-8: Build-up Recovery Partition	100
Figure C-9: Press any key to continue	100
Figure C-10: Press F3 to Boot into Recovery Mode.....	101
Figure C-11: Recovery Tool Menu	101
Figure C-12: About Symantec Ghost Window.....	102
Figure C-13: Symantec Ghost Path	102
Figure C-14: Select a Local Source Drive	103
Figure C-15: Select a Source Partition from Basic Drive	103
Figure C-16: File Name to Copy Image to	104
Figure C-17: Compress Image.....	104
Figure C-18: Image Creation Confirmation	105
Figure C-19: Image Creation Process.....	105
Figure C-20: Image Creation Complete	105
Figure C-21: Press Any Key to Continue	106
Figure C-22: Partitions for Linux.....	107
Figure C-23: System Configuration for Linux.....	108
Figure C-24: Access menu.lst in Linux (Text Mode).....	108
Figure C-25: Recovery Tool Menu	109
Figure C-26: Recovery Tool Main Menu	110
Figure C-27: Restore Factory Default.....	111
Figure C-28: Recovery Complete Window	111

Figure C-29: Backup System	112
Figure C-30: System Backup Complete Window	112
Figure C-31: Restore Backup	113
Figure C-32: Restore System Backup Complete Window	113
Figure C-33: Symantec Ghost Window	114

List of Tables

Table 1-1: Technical Specifications	7
Table 2-1: Packing List	11
Table 2-2: Optional Items	12
Table 3-1: Internal Peripheral Connectors	15
Table 3-2: External Peripheral Connectors	16
Table 3-3: Battery Connector Pinouts	17
Table 3-4: CPU Fan Connector Pinouts	18
Table 3-5: System Fan Connector Pinouts	19
Table 3-6: Digital I/O Connector Pinouts	21
Table 3-7: Front Panel Connector Pinouts	22
Table 3-8: Parallel Port Connector Pinouts	24
Table 3-9: RS-232/422/485 Serial Port Connector Pinouts	26
Table 3-10: SATA Drive Connector Pinouts	27
Table 3-11: SMBus Connector Pinouts	28
Table 3-12: SPI Flash Connector	28
Table 3-13: USB Port Connector Pinouts	29
Table 3-14: TPM Connector Pinouts	30
Table 3-15: Keyboard Connector Pinouts	31
Table 3-16: LAN Pinouts	33
Table 3-17: Serial Port Pinouts	34
Table 3-18: Serial Port Pinouts	35
Table 3-19: USB Port Pinouts	35
Table 3-20: VGA Connector Pinouts	36
Table 4-1: Jumpers	41
Table 4-2: Clear BIOS Jumper Settings	42
Table 4-3: USB6, 7 power Jumper Settings	42
Table 4-4: COM 6 Function Select Jumper Settings	43
Table 5-1: BIOS Navigation Keys	55

BIOS Menus

BIOS Menu 1: Main	56
BIOS Menu 2: Advanced	57
BIOS Menu 3: ACPI Settings	58
BIOS Menu 4: TPM Configuration	59
BIOS Menu 5: CPU Configuration	60
BIOS Menu 6: IDE Configuration	61
BIOS Menu 7: USB Configuration	62
BIOS Menu 8: Super IO Configuration.....	63
BIOS Menu 9: Serial Port n Configuration Menu	64
BIOS Menu 10: Parallel Port Configuration Menu	69
BIOS Menu 11: Hardware Health Configuration	70
BIOS Menu 12: Serial Port Console Redirection	72
BIOS Menu 13: Chipset	73
BIOS Menu 14: Host Bridge Chipset Configuration.....	74
BIOS Menu 15: South Bridge Chipset Configuration.....	75
BIOS Menu 16: South Bridge Chipset Configuration.....	77
BIOS Menu 17: Boot	78
BIOS Menu 18: Security	80
BIOS Menu 19:Exit.....	81

Chapter

1

Introduction

1.1 Introduction

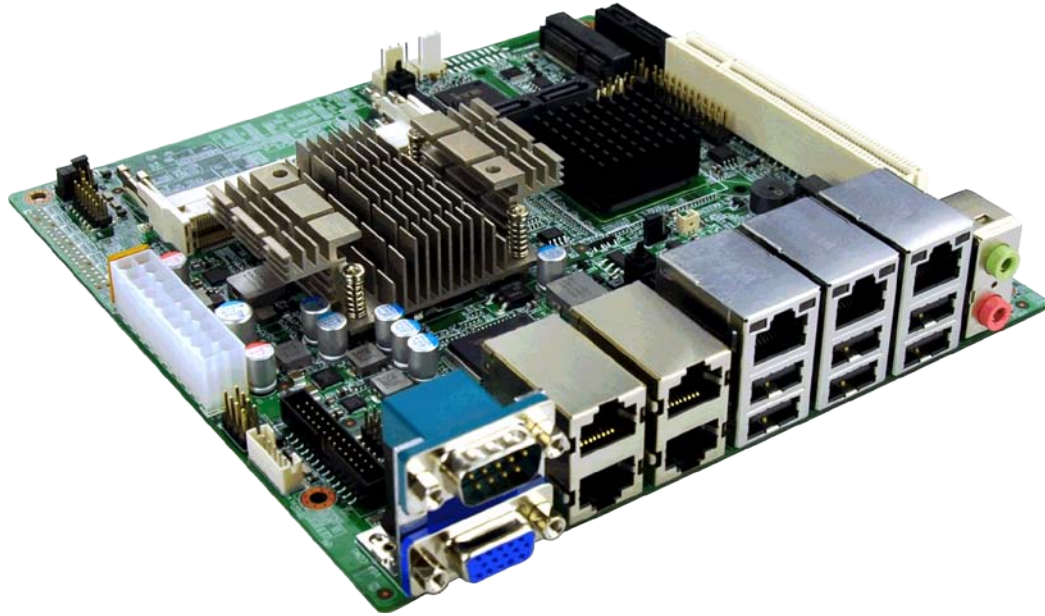

Figure 1-1: KINO-PV-D5253/D4253

The KINO-PV-D5253/D4253 Mini-ITX motherboard is a Intel® Atom™ processor D525 or D425 platform. Supports two DDR3 SO-DIMMs up to 2.0 GB each (4.0 GB total),

The integrated Intel® ICH8M Chipset supports Three GbE LAN ports through the Realtek RTL8111E Ethernet controller (with ASF 2.0 support), also supports two SATA 3Gb/s drives.

The KINO-PV-D5253/D4253 includes one VGA output, Eight USB2.0, two PCIe mini sockets, one PCI slot, one PCIe x1 slot, one parallel port, audio jacks provides flexible expansion options. Serial device connectivity is provided by four RS-232 serial ports (RJ-45), one RS-232 serial ports (DB-9), and one internal RS-232/422/485 connectors.

1.2 Benefits

Some of the KINO-PV-D5253/D4253 motherboard benefits include:

- Powerful graphics
- Staying connected with both wired LAN connections
- Speedy running of multiple programs and applications

KINO-PV-D5253-D4253 Mini-ITX Motherboard

1.3 Features

Some of the KINO-PV-D5253/D4253 motherboard features are listed below:

- Mini-ITX form factor
- Intel® Atom™ D525 /D425 Processor
- Supports two DDR3 SODIMM
- Three Gigabit Ethernet connectors
- Two SATA connectors
- Eight USB ports
- Six serial ports
- RoHS compliant

1.4 Connectors

The connectors on the KINO-PV-D5253/D4253 are shown in the figure below.

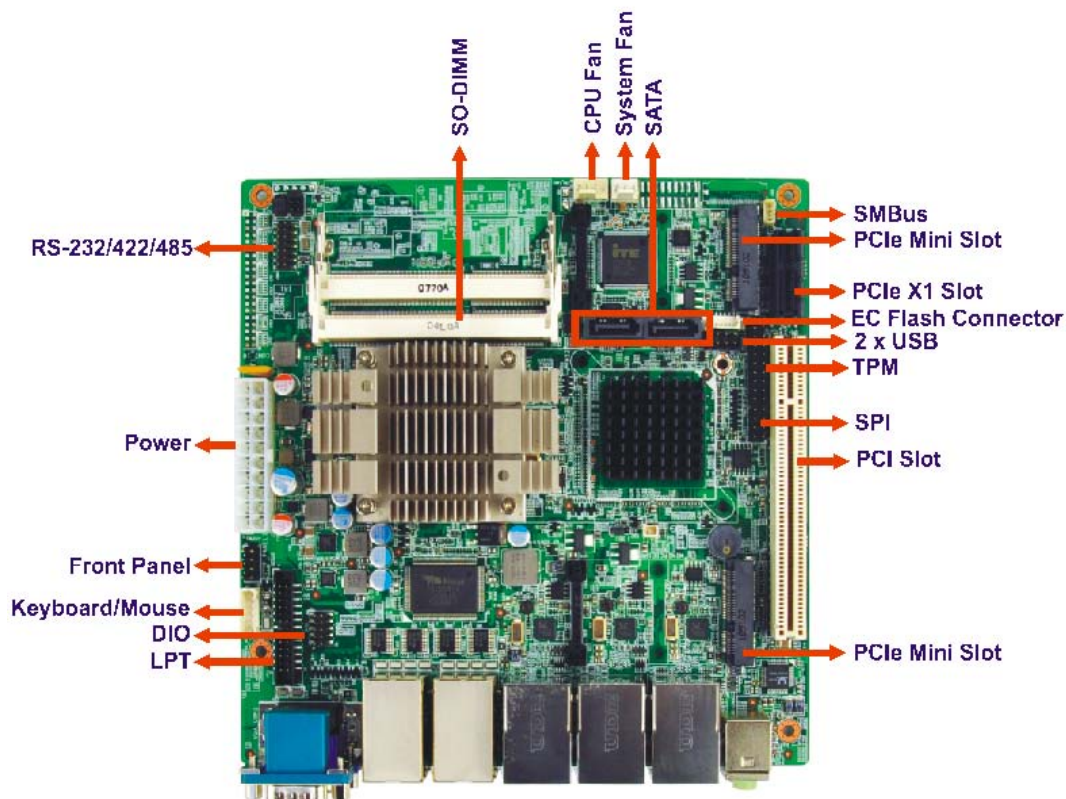

Figure 1-2: Connectors

1.5 Dimensions

The main dimensions of the KINO-PV-D5253/D4253 are shown in the diagram below.

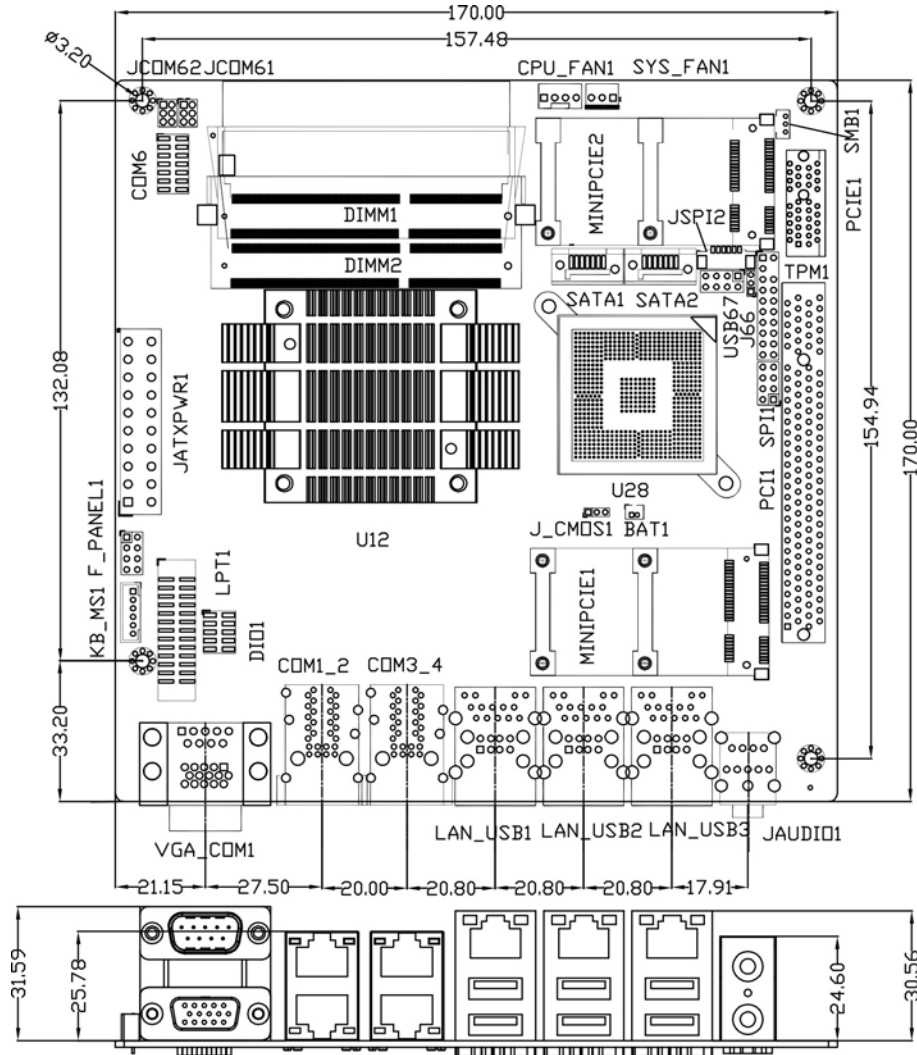

Figure 1-3: Dimensions (mm)

1.6 Data Flow

Figure 1-4 shows the data flow between the system chipset, the CPU and other components installed on the motherboard.

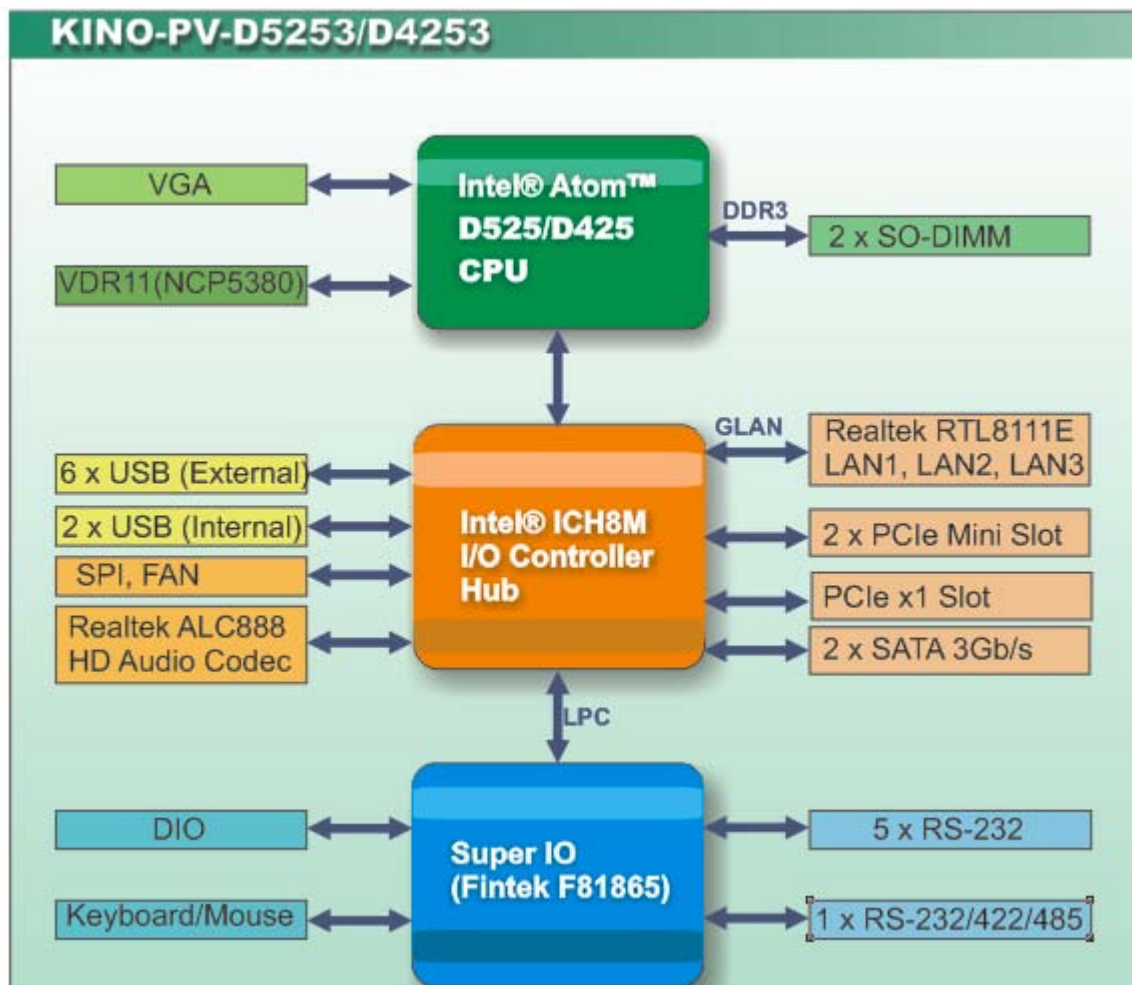

Figure 1-4: Data Flow Diagram

1.7 Technical Specifications

KINO-PV-D5253/D4253 technical specifications are shown below.

Specification	KINO-PV-D5253/D4253
Form Factor	Mini-ITX

Specification	KINO-PV-D5253/D4253
CPU options	Intel® Atom™ processor D525, 1.8 GHz/1 MB L2 cache Intel® Atom™ processor D425, 1.8 GHz/512 KB L2 cache
Express Chipset	Intel® ICH8M
Memory	2 x SO-DIMM DDR3 800MHz up to 4GB
Audio	Realtek ALC888 HD 7.1 channel audio codec
LAN	3 x Realtek RTL8111E PCIe GbE controller with ASF 2.0 support
Super I/O	Fintek F81865
BIOS	uEFI BIOS
EC	IT8519
Digital I/O	8-bit, 4-bit input/4-bit output
Watchdog Timer	Software programmable supports 1~255 sec. system reset
Expansion	
PCIe	2 x PCIe Mini slots 1 x PCIe x1 slot
PCI	1 x PCI slot
I/O Interface Connectors	
Audio Connector	1 x Line-out 1 x Mic-in
Display Ports	1 x VGA port (2048x1536)
Ethernet	3 x RJ-45 GbE ports
Fan connector	1 x 4-pin CPU fan connector with smart fan control 1 x 3-pin system fan
SMBus	1 x 4-pin wafer connector
TPM	2 x 10-pin header
Keyboard/Mouse	1 x KB/MS pin header

KINO-PV-D5253-D4253 Mini-ITX Motherboard

Specification	KINO-PV-D5253/D4253
Serial Ports	4 x RS-232 (RJ-45) 1 x RS-232 (DB-9) 1 x RS-232/422/485 (pin header)
USB 2.0/1.1 Ports	6 x External USB ports 2 x Internal USB ports via one 8-pin headers
Parallel Ports	1 x LPT connector via 26-pin header
Storage	
Serial ATA	2 x SATA 3.0 Gb/s connectors.
Environmental and Power Specifications	
Power Supply	ATX and AT power supported
Power Connector	One internal 20-pin power connector for power supply
Power Consumption	5 V @ 2.62 A, Vcore_12 V @ 0.76 A (1.8 GHz Intel® Atom™ D525 dual-core CPU with one 1 GB DDR3 SO-DIMM)
Operating Temperature	-20°C ~ 60°C with free air, -20°C ~ 70°C with force air for D525 processor -20°C ~ 65°C with free air, -20°C ~ 70°C with force air for D425 processor
Humidity	5% ~ 95% (non-condensing)
Physical Specifications	
Dimensions	170 mm x 170 mm
Weight GW/NW	900 g / 360 g

Table 1-1: Technical Specifications



Chapter

2

Packing List

2.1 Anti-static Precautions



WARNING!

Static electricity can destroy certain electronics. Make sure to follow the ESD precautions to prevent damage to the product, and injury to the user.

Make sure to adhere to the following guidelines:

- **Wear an anti-static wristband:** Wearing an anti-static wristband can prevent electrostatic discharge.
- **Self-grounding:** Touch a grounded conductor every few minutes to discharge any excess static buildup.
- **Use an anti-static pad:** When configuring any circuit board, place it on an anti-static mat.
- **Only handle the edges of the PCB:** Don't touch the surface of the motherboard. Hold the motherboard by the edges when handling.

2.2 Unpacking Precautions

When the KINO-PV-D5253/D4253 is unpacked, please do the following:

- Follow the antistatic guidelines above.
- Make sure the packing box is facing upwards when opening.
- Make sure all the packing list items are present.





2.3 Packing List



NOTE:

If any of the components listed in the checklist below are missing, do not proceed with the installation. Contact the IEI reseller or vendor the KINO-PV-D5253/D4253 was purchased from or contact an IEI sales representative directly by sending an email to sales@iei.com.tw.

The KINO-PV-D5253/D4253 is shipped with the following components:

Quantity	Item and Part Number	Image
1	KINO-PV-D5253/D4253 SBC	
1	SATA cable (P/N: 32000-062800-RS)	
1	Mini jumper pack (2.0mm) (P/N:33100-000033-RS)	
1	IO shielding (P/N:45014-0033C0-00-RS)	
1	Utility CD	

KINO-PV-D5253-D4253 Mini-ITX Motherboard







Quantity	Item and Part Number	Image
1	Quick Installation Guide	

Table 2-1: Packing List

2.4 Optional Items

The following are optional components which may be separately purchased:

Item and Part Number	Image
PS2 KB/MS Cable (P/N: 32000-023800-RS)	
LPT cable (w/o bracket) (P/N: 32200-015100-RS)	
SATA power cable (P/N: 32102-000100-100-RS 32102-000100-200-RS 32102-000100-300-RS)	
RJ-45 to RS-232 cable (P/N: 32005-000200-00-RS)	
Dual USB port cable (P/N: CB-USB02-RS)	
PCIex1 riser card (P/N: PCIER-K101L-R10)	



Item and Part Number	Image
RS-232/422/485 cable (P/N: 19800-000110-RS)	
Infineon 20 pin trusted platform module (P/N: TPM-IN01-R11)	

Table 2-2: Optional Items

Chapter

3

Connectors

3.1 Peripheral Interface Connectors

This chapter details all the jumpers and connectors.

3.1.1 Layout

The figure below shows all the connectors and jumpers.

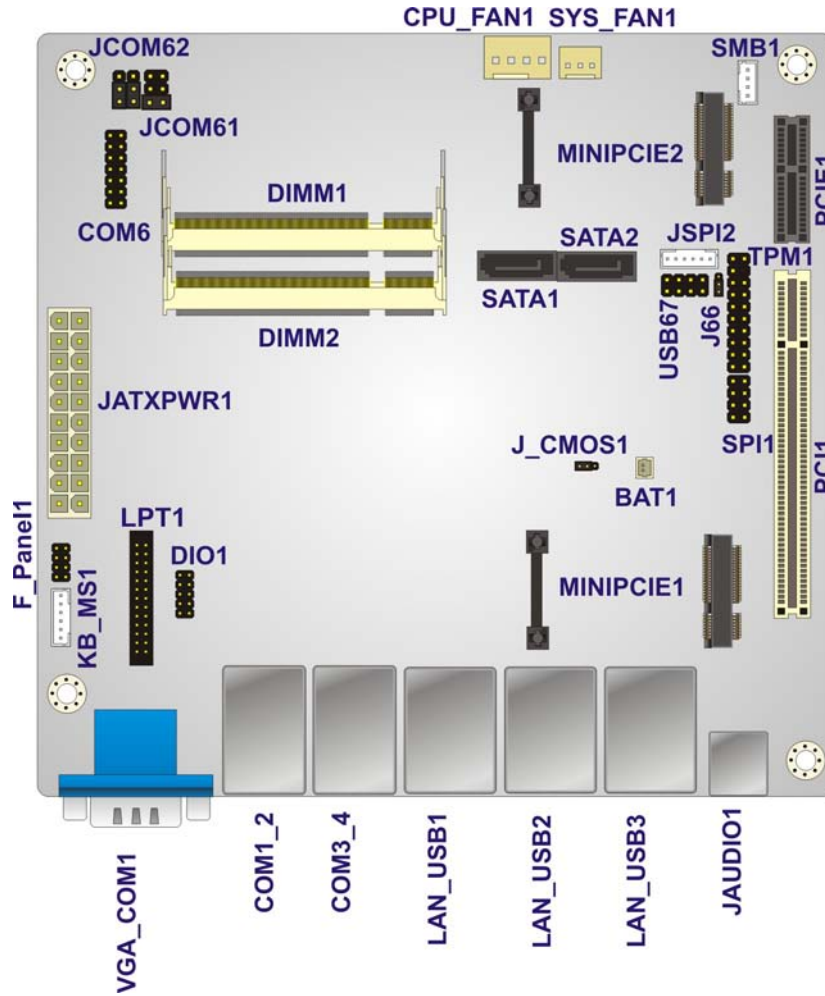

Figure 3-1: Connectors and Jumpers

3.1.2 Peripheral Interface Connectors

The table below lists all the connectors on the board.

KINO-PV-D5253-D4253 Mini-ITX Motherboard

Connector	Type	Label
Battery connector	2-pin wafer	BAT1
Fan connector (CPU)	4-pin wafer	CPU_FAN1
Fan connector (system)	3-pin wafer	SYS_FAN1
Standard ATX power connector	20-pin connector	JATXPWR1
Digital I/O connector	10-pin header	DIO1
Front panel connector	8-pin header	F_PANEL1
Memory slot	204-pin DDR3 DIMM slot	DIMM1, DIMM2
Parallel port connector	26-pin header	LPT1
RS-232/422/485 serial port connector	14-pin header	COM6
SATA drive connectors	7-pin SATA drive connectors	SATA1, SATA2,
SMBus connector	4-pin wafer	SMB1
SPI Flash connector	8-pin header	SPI1
SPI Flash connector	8-pin header	JSPI2
USB connector	8-pin header	USB67
TPM connector	20-pin connector	TPM1
KB/MS wafer	6-pin header	KB_MS1
PCI slot	PCI slot	PC11
PCIe x1 slot	PCIe x1 slot	PCIE1
PCIe Mini slot	PCIe Mini slot	MINIPCE1
PCIe Mini slot	PCIe Mini slot	MINIPCE2

Table 3–1: Internal Peripheral Connectors

3.1.3 External Interface Panel Connectors

The table below lists the connectors on the external I/O panel.

Connector	Type	Label
Audio connector	Audio jack	JAUDIO1

Connector	Type	Label
LAN/USB connector	RJ-45	LAN_USB1 LAN_USB2 LAN_USB3
Serial Port connector	RJ-45	COM1_2 COM3_4
VGA/Serial Port connector	VGA/DB-9	VGA_COM1

Table 3–2: External Peripheral Connectors

3.2 Internal Peripheral Connectors

The section describes all of the connectors on the KINO-PV-D5253/D4253.

3.2.1 Battery Connector

CN Label:	BAT1
CN Type:	2-pin wafer
CN Location:	See Figure 3-2
CN Pinouts:	See Table 3-3

This is connected to the system battery. The battery provides power to the system clock to retain the time when power is turned off.

KINO-PV-D5253-D4253 Mini-ITX Motherboard

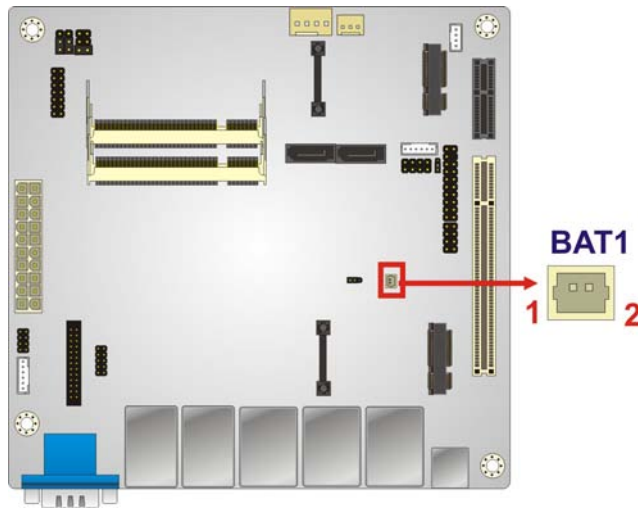

Figure 3-2: Battery Connector Location

Pin	Description
1	Battery+ (+3V)
2	Ground

Table 3-3: Battery Connector Pinouts

3.2.2 CPU Fan Connector

- CN Label: CPU_FAN1
- CN Type: 4-pin wafer
- CN Location: See **Figure 3-3**
- CN Pinouts: See **Table 3-4**

The fan connector attaches to a CPU cooling fan.

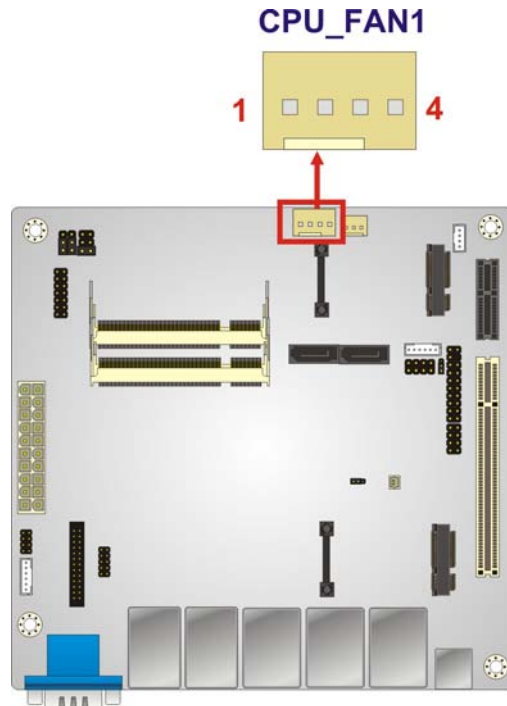
Figure 3-3: CPU Fan Connector Location

Pin	Description
1	GND
2	+12 V
3	Fan In
4	Fan Control

Table 3-4: CPU Fan Connector Pinouts

3.2.3 System Fan Connector

CN Label:	SYS_FAN1
CN Type:	3-pin wafer
CN Location:	See Figure 3-4
CN Pinouts:	See Table 3-5

The fan connector attaches to a system cooling fan.

KINO-PV-D5253-D4253 Mini-ITX Motherboard

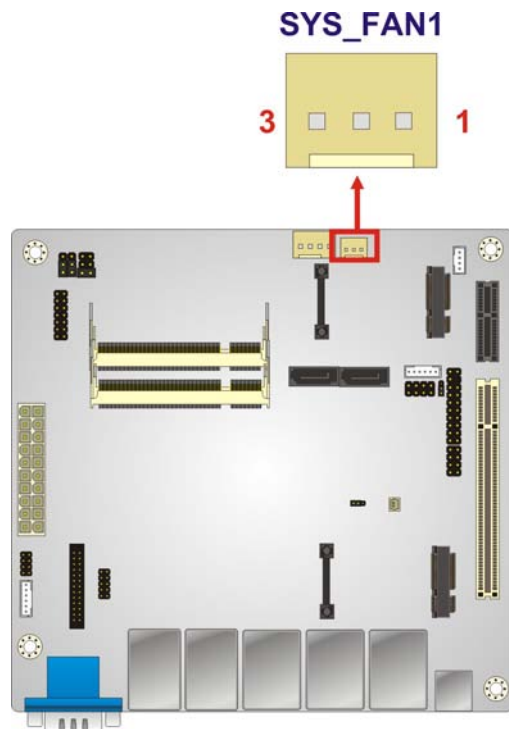

Figure 3-4: System Fan Connector Location

Pin	Description
1	Fan In
2	VCC_FAN
3	GND

Table 3-5: System Fan Connector Pinouts

3.2.4 Standard ATX power connector

- CN Label: JATXPWR 1
- CN Type: 20-pin connector
- CN Location: See **Figure 3-5**
- CN Pinouts: See **Table 3-6**

The standard ATX power input connector provides power to the motherboard.

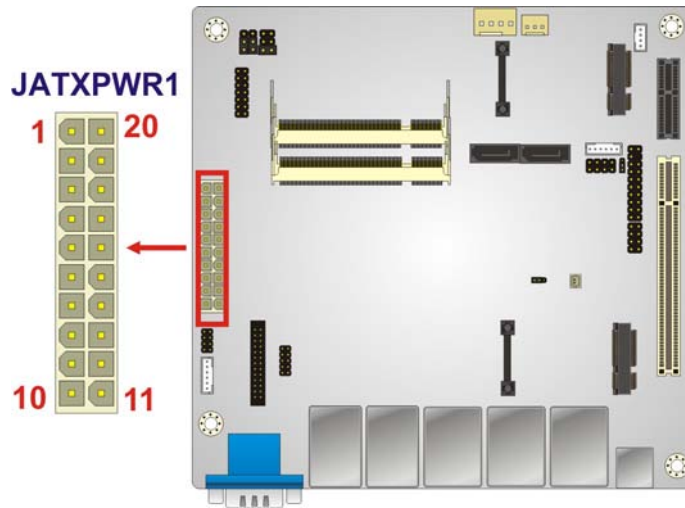

Figure 3-5: ATX Power Input Connector Location

Pin	Description	Pin	Description
1	3.3V	11	3.3V
2	3.3V	12	-12V
3	GND	13	GND
4	5V	14	PS_ON#
5	GND	15	GND
6	5V	16	GND
7	GND	17	GND
8	PWROK	18	-5V
9	5VSB	19	5V
10	12V	20	5V

Table 3-6: ATX Power Connector Pinouts

3.2.5 Digital I/O Connector

- CN Label: DIO1
- CN Type: 10-pin header
- CN Location: See **Figure 3-6**
- CN Pinouts: See **Table 3-6**

KINO-PV-D5253-D4253 Mini-ITX Motherboard

The digital I/O connector provides programmable input and output for external devices. The digital I/O provides 4-bit output and 4-bit input.

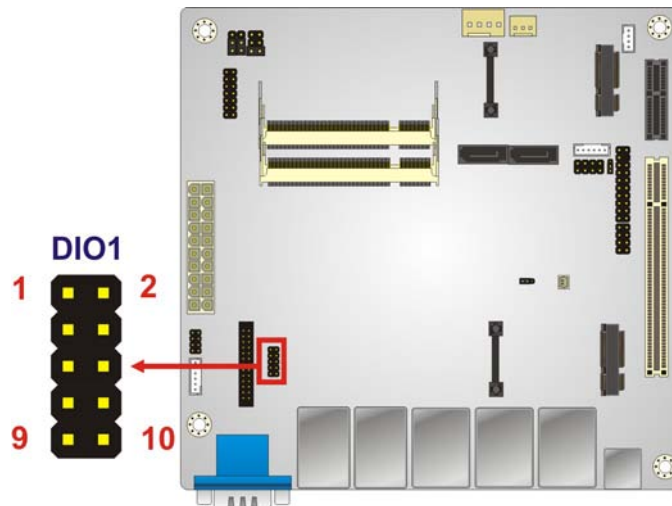

Figure 3-6: Digital I/O Connector Locations

Pin	Description	Pin	Description
1	GND	2	VCC5S
3	Output 3	4	Output 2
5	Output 1	6	Output 0
7	Input 3	8	Input 2
9	Input 1	10	Input 0

Table 3-6: Digital I/O Connector Pinouts

3.2.6 Front Panel Connector

- CN Label: F_PANEL1
- CN Type: 8-pin header
- CN Location: See **Figure 3-7**
- CN Pinouts: See **Table 3-7**

The front panel connector connects to the indicator LEDs and buttons on the computer's front panel.

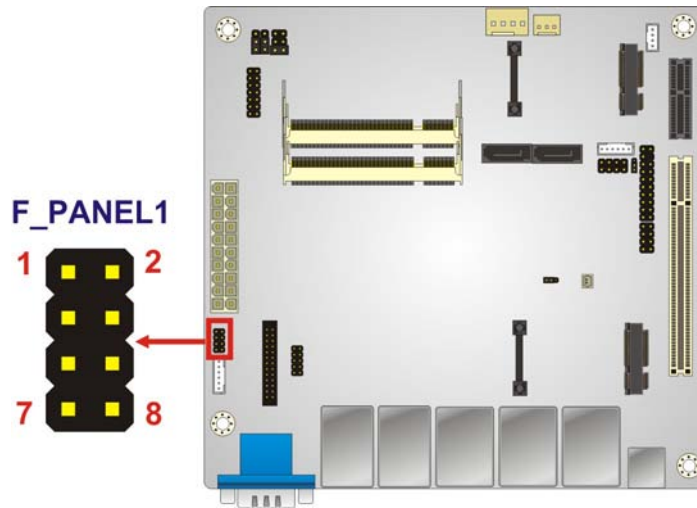
Figure 3-7: Front Panel Connector Location

Pin	Description	Pin	Description
1	PWRBTSW#	2	PWRLED
3	GND	4	GND
5	5V	6	SYS_RST#
7	HDDLED#	8	GND

Table 3-7: Front Panel Connector Pinouts

3.2.7 Memory Slot

CN Label: SODIMM1, SODIMM2

CN Type: SODIMM slot

CN Location: See **Figure 3-8**

The SODIMM slots are for SODIMM memory modules.

KINO-PV-D5253-D4253 Mini-ITX Motherboard

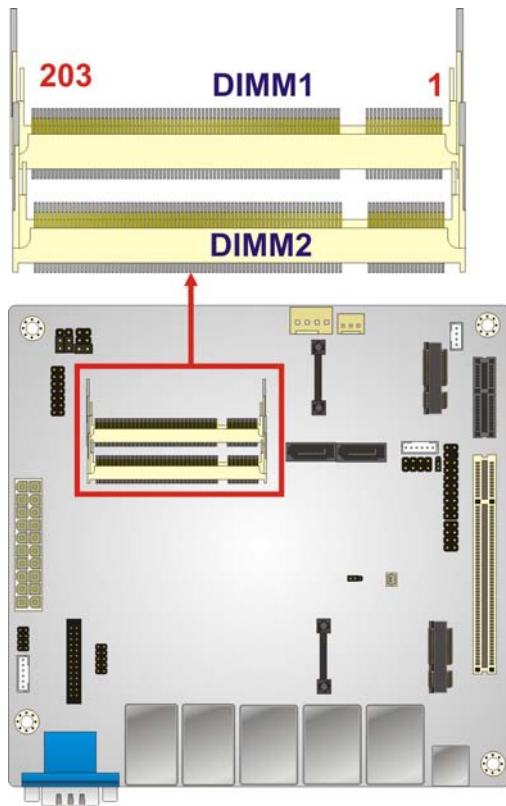

Figure 3-8: Memory Card Slot Location

3.2.8 Parallel Port Connector

- CN Label: LPT1
- CN Type: 26-pin header
- CN Location: See **Figure 3-9**
- CN Pinouts: See **Table 3-8**

The parallel port connector connects to a parallel port connector interface or some other parallel port device such as a printer.

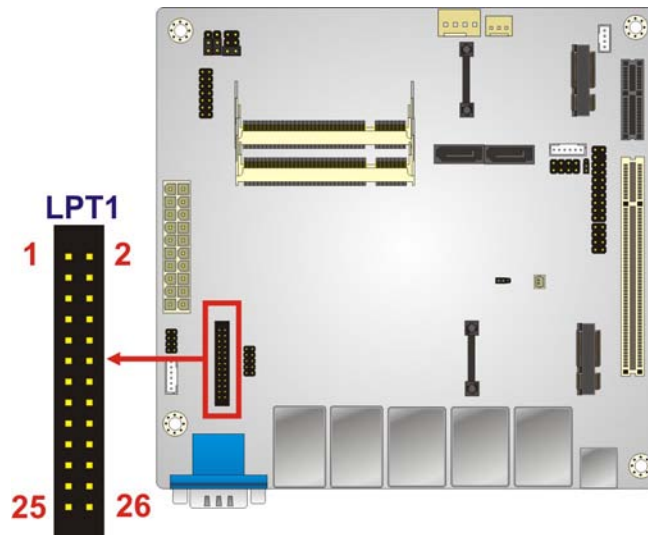

Figure 3-9: Parallel Port Connector Location

Pin	Description	Pin	Description
1	STB-	2	AFD-
3	PD0	4	ERR-
5	PD1	6	INIT
7	PD2	8	SLIN-
9	PD3	10	GND
11	PD4	12	GND
13	PD5	14	GND
15	PD6	16	GND
17	PD7	18	GND
19	ACK-	20	GND
21	BUSY	22	GND
23	PE	24	GND
25	SLCT	26	NC

Table 3-8: Parallel Port Connector Pinouts

3.2.9 RS-232/422/485 Serial Port Connector

CN Label: COM6

KINO-PV-D5253-D4253 Mini-ITX Motherboard

- CN Type: 14-pin header
- CN Location: See **Figure 3-10**
- CN Pinouts: See **Table 3-9**

This connector provides RS-232, RS-422 or RS-485 communications.

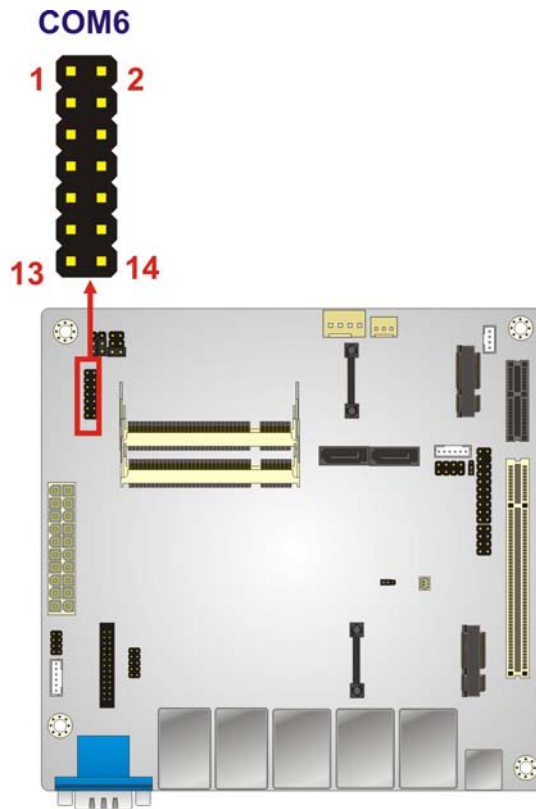

Figure 3-10: RS-232/422/485 Serial Port Connector

Pin	Description	Pin	Description
1	DCD	2	DSR
3	RX(host)	4	RTS
5	TX(host)	6	CTS
7	DTR	8	RI
9	GND	10	NC
11	TX+	12	TX-
13	RX+	14	RX-

Pin	Description	Pin	Description
-----	-------------	-----	-------------

Table 3-9: RS-232/422/485 Serial Port Connector Pinouts

3.2.10 SATA Drive Connectors

- CN Label: SATA1, SATA3
- CN Type: 7-pin SATA drive connectors
- CN Location: See **Figure 3-11**
- CN Pinouts: See **Table 3-10**

The SATA drive connectors can be connected to SATA 3Gb/s drives.

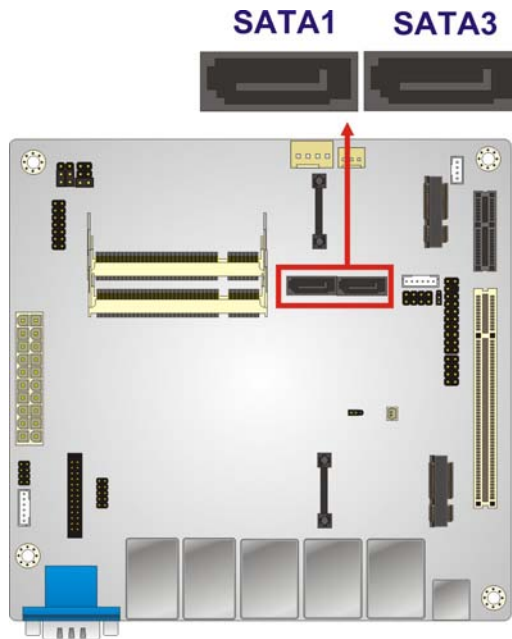

Figure 3-11: SATA Drive Connector Location

PIN NO.	DESCRIPTION
1	GND
2	TX+
3	TX-
4	GND
5	RX-

KINO-PV-D5253-D4253 Mini-ITX Motherboard

6	RX+
7	GND

Table 3-10: SATA Drive Connector Pinouts

3.2.11 SMBus Connector

CN Label:	CMB 1
CN Type:	4-pin wafer
CN Location:	See Figure 3-12
CN Pinouts:	See Table 3-11

The SMBus (System Management Bus) connector provides low-speed system management communications.

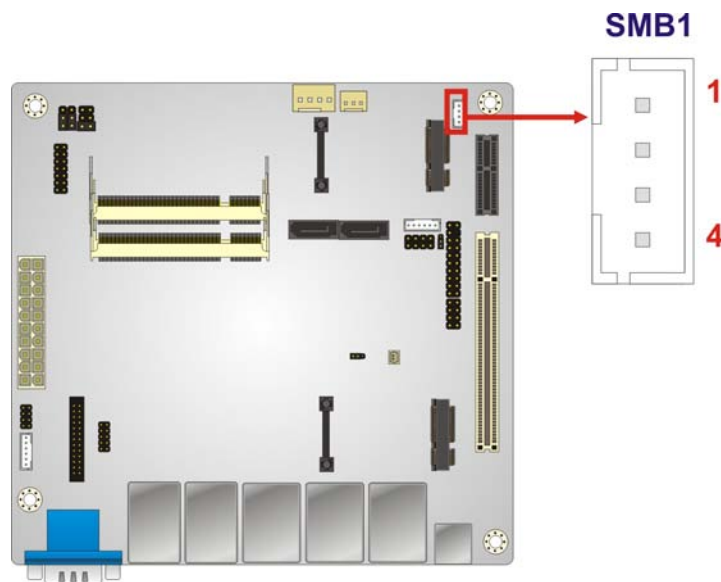

Figure 3-12: SMBus Connector Location

Pin	Description
1	GND
2	SMbus_DATA

Pin	Description
3	SMBus_CLK
4	+5V

Table 3-11: SMBus Connector Pinouts

3.2.12 SPI Flash Connector

CN Label:	SPI1
CN Type:	8-pin header
CN Location:	See Figure 3-13
CN Pinouts:	See Table 3-12

The 8-pin SPI Flash connector is used to flash the BIOS.

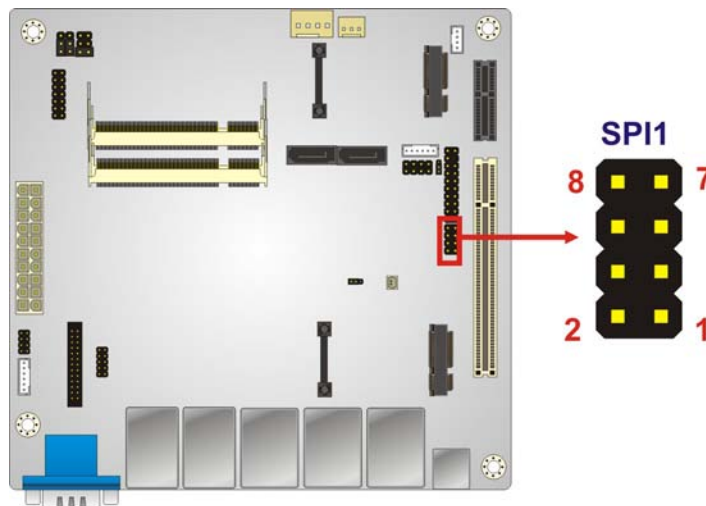
Figure 3-13: SPI Flash Connector

Pin	Description	Pin	Description
1	+3.3V	2	GND
3	CS#	4	CLOCK
5	MISO	6	MOSI
7	NC	8	NC

Table 3-12: SPI Flash Connector

KINO-PV-D5253-D4253 Mini-ITX Motherboard

3.2.13 USB Connectors

CN Label:	USB67
CN Type:	8-pin header
CN Location:	See Figure 3-14
CN Pinouts:	See Table 3-13

The USB connectors connect to USB devices. Each pin header provides two USB ports.

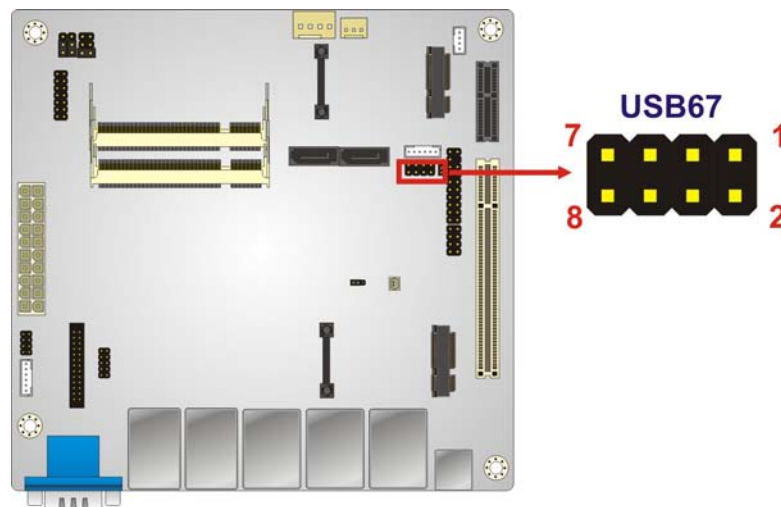

Figure 3-14: USB Connector Pinout Locations

Pin	Description	Pin	Description
1	+5V	2	+5V
3	DATA_6N	4	DATA_7P
5	DATA_6P	6	DATA_7N
7	GND	8	GND

Table 3-13: USB Port Connector Pinouts

3.2.14 TPM Connector

CN Label:	TPM1
CN Type:	20-pin header
CN Location:	See Figure 3-15

CN Pinouts: See **Table 3-14**

This connector secures the system on bootup.

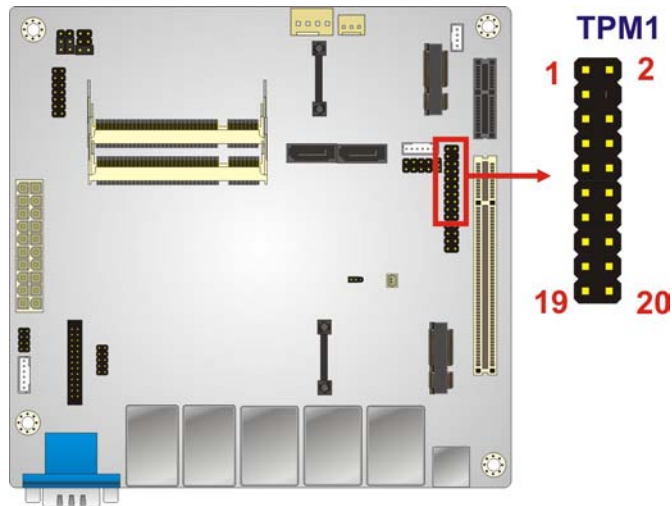

Figure 3-15: TPM Connector

Pin	Description	Pin	Description
1	TPM_CLK	2	GND
3	LPC_FRAME#	4	NC
5	PLT_RST#	6	5V
7	LPC_AD3	8	LPC_AD2
9	3.3V	10	LPC_AD1
11	LPC_ADO	12	GND
13	SMBCLK	14	SMBDATA
15	3.3VSB	16	INT_SERIRQ
17	GND	18	PM_CLKRUN
19	3.3V	20	L_DRQ#

Table 3-14: TPM Connector Pinouts

3.2.15 Keyboard/Mouse Wafer

CN Label: KB_MS1

CN Type: 6-pin header

KINO-PV-D5253-D4253 Mini-ITX Motherboard

CN Location: See **Figure 3-16**

CN Pinouts: See **Table 3-15**

This connector connects to a PS/2 Y-cable that can be connected to a PS/2 keyboard and mouse.

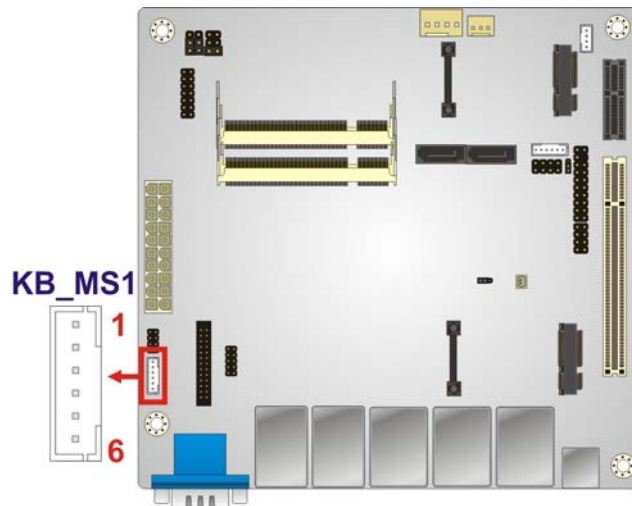

Figure 3-16: Keyboard/Mouse Connector Location

Pin	Description
1	+5 VCC
2	MS DATA
3	MS CLK
4	KB DATA
5	KB CLK
6	GROUND

Table 3-15: Keyboard Connector Pinouts

3.2.16 PCIe Mini Card Slot

CN Label: MINIPCIE 1, MINIPCIE 2

CN Type: PCIe Mini card slot

CN Location: See **Figure 3-17**

The PCIe Mini card slot is for installing PCIe Mini expansion cards.

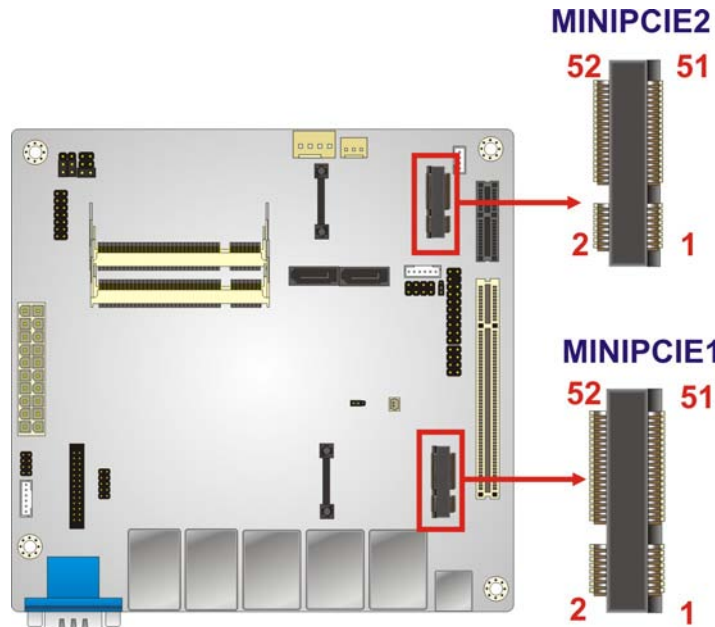

Figure 3-17: PCIe Mini Card Slot Location

3.3 External Peripheral Interface Connector Panel

The figure below shows the external peripheral interface connector (EPIC) panel. The EPIC panel consists of the following:

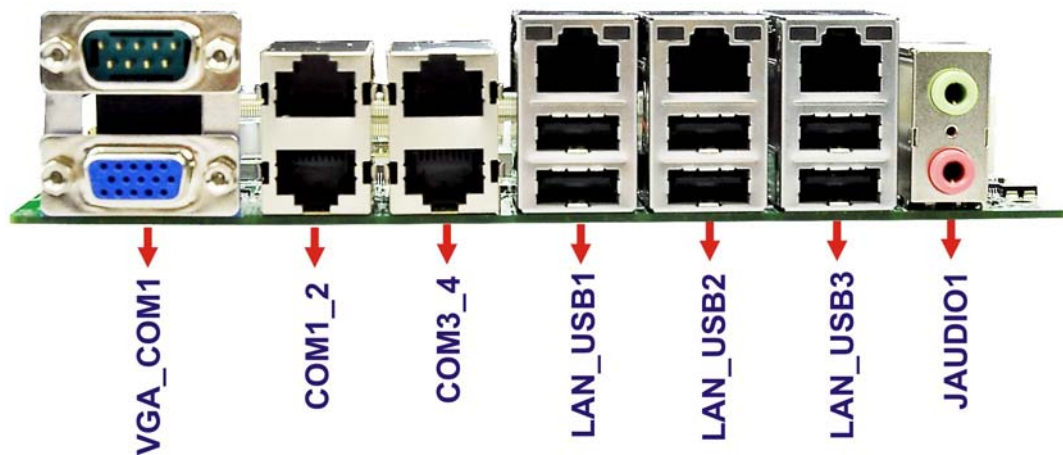

Figure 3-18: External Peripheral Interface Connector

KINO-PV-D5253-D4253 Mini-ITX Motherboard

3.3.1 Audio Connector

CN Label: J AUDIO1
 CN Type: Audio jacks
 CN Location: See **Figure 3-19**

The audio jacks connect to external audio devices.

- **Line Out port (Lime):** Connects to a headphone or a speaker. With multi-channel configurations, this port can also connect to front speakers.
- **Microphone (Pink):** Connects a microphone.



Figure 3-19: Audio Connector

3.3.2 LAN Connector

CN Label: LAN_USB1, LAN_USB2, LAN_USB3
 CN Type: RJ-45
 CN Location: See **Figure 3-18**
 CN Pinouts: See **Table 3-16**

The LAN connector connects to a local network.

Pin	Description	Pin	Description
1	MDIA3-	5	MDIA1+
2	MDIA3+	6	MDIA2+-
3	MDIA2-	7	MDIA0-
4	MDIA1-	8	MDIA0+

Table 3-16: LAN Pinouts

3.3.3 Serial Port Connectors (COM1)

- CN Label: VGA_COM1
- CN Type: DB-9 connectors
- CN Location: See **Figure 3-18**
- CN Pinouts: See **Table 3-17** and **Figure 3-20**

The serial port connects to a RS-232 serial communications device.

Pin	Description	Pin	Description
1	DCD	6	DSR
2	RX	7	RTS
3	TX	8	CTS
4	DTR	9	RI
5	GND		

Table 3-17: Serial Port Pinouts

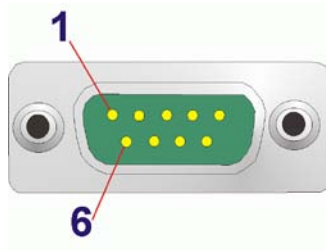

Figure 3-20: Serial Port Pinouts

3.3.4 Serial Port Connectors (COM1_2, COM3_4)

- CN Label: COM1_2, COM3_4
- CN Type: RJ-45 connectors
- CN Location: See **Figure 3-18**
- CN Pinouts: See **Table 3-18**

The serial port connects to a RS-232 serial communications device.

KINO-PV-D5253-D4253 Mini-ITX Motherboard

Pin	Description	Pin	Description
1	DCD	6	CTS
2	DSR	7	DRT
3	RX	8	RI
4	RTS	9	GND
5	TX		

Table 3-18: Serial Port Pinouts

3.3.5 USB Connector

CN Label: LAN_USB 1, LAN_USB 2, LAN_USB 3

CN Type: USB port

CN Location: See **Figure 3-18**

CN Pinouts: See **Table 3-19**

The USB connector can be connected to a USB device.

Pin	Description	Pin	Description
1	+5 V	2	+5 V
3	DATA-	4	DATA-
5	DATA+	6	DATA+
7	GND	8	GND

Table 3-19: USB Port Pinouts

3.3.6 VGA Connector

CN Label: VGA_COM1

CN Type: 15-pin Female

CN Location: See **Figure 3-18**

CN Pinouts: See **Figure 3-21** and **Table 3-20**

The VGA connector connects to a monitor that accepts a standard VGA input.

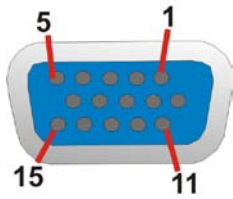

Figure 3-21: VGA Connector

Pin	Description	Pin	Description
1	RED	2	GREEN
3	BLUE	4	NC
5	GND	6	GND
7	GND	8	GND
9	VCC / NC	10	GND
11	NC	12	DDC DAT
13	HSYNC	14	VSYNC
15	DDCCLK		

Table 3-20: VGA Connector Pinouts

Chapter

4

Installation

4.1 Anti-static Precautions



WARNING:

Failure to take ESD precautions during the installation of the KINO-PV-D5253/D4253 may result in permanent damage to the KINO-PV-D5253/D4253 and severe injury to the user.

Electrostatic discharge (ESD) can cause serious damage to electronic components, including the KINO-PV-D5253/D4253. Dry climates are especially susceptible to ESD. It is therefore critical that whenever the KINO-PV-D5253/D4253 or any other electrical component is handled, the following anti-static precautions are strictly adhered to.

- **Wear an anti-static wristband:** Wearing a simple anti-static wristband can help to prevent ESD from damaging the board.
- **Self-grounding:** Before handling the board, touch any grounded conducting material. During the time the board is handled, frequently touch any conducting materials that are connected to the ground.
- **Use an anti-static pad:** When configuring the KINO-PV-D5253/D4253, place it on an anti-static pad. This reduces the possibility of ESD damaging the KINO-PV-D5253/D4253.
- **Only handle the edges of the PCB:** When handling the PCB, hold the PCB by the edges.

4.2 Installation Considerations



NOTE:

The following installation notices and installation considerations should be read and understood before installation. All installation notices must be strictly adhered to. Failing to adhere to these precautions may lead to severe damage and injury to the person performing the installation.

KINO-PV-D5253-D4253 Mini-ITX Motherboard

**WARNING:**

The installation instructions described in this manual should be carefully followed in order to prevent damage to the components and injury to the user.

Before and during the installation please **DO** the following:

- Read the user manual:
 - The user manual provides a complete description of the KINO-PV-D5253/D4253 installation instructions and configuration options.
- Wear an electrostatic discharge cuff (ESD):
 - Electronic components are easily damaged by ESD. Wearing an ESD cuff removes ESD from the body and helps prevent ESD damage.
- Place the KINO-PV-D5253/D4253 on an antistatic pad:
 - When installing or configuring the motherboard, place it on an antistatic pad. This helps to prevent potential ESD damage.
- Turn all power to the KINO-PV-D5253/D4253 off:
 - When working with the KINO-PV-D5253/D4253, make sure that it is disconnected from all power supplies and that no electricity is being fed into the system.

Before and during the installation of the KINO-PV-D5253/D4253 **DO NOT:**

- Remove any of the stickers on the PCB board. These stickers are required for warranty validation.
- Use the product before verifying all the cables and power connectors are properly connected.
- Allow screws to come in contact with the PCB circuit, connector pins, or its components.

4.3 Basic Installation

This section outlines the parts that must be installed for the system to function correctly.

4.3.1 SO-DIMM Installation

To install an SO-DIMM, please follow the steps below and refer to **Figure 4-1**.

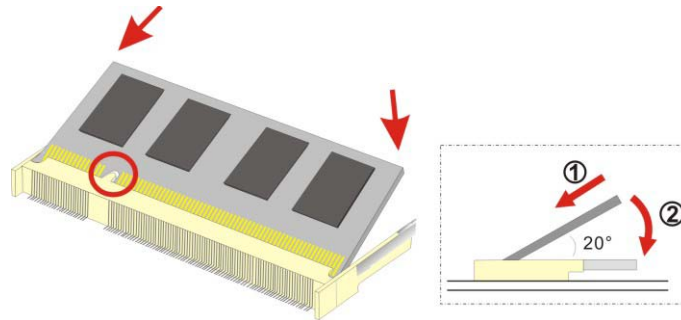

Figure 4-1: SO-DIMM Installation

Locate the SO-DIMM socket. Place the board on an anti-static mat.

Align the SO-DIMM with the socket. Align the notch on the memory with the notch on the memory socket.

Insert the SO-DIMM. Push the memory in at a 20° angle. (See **Figure 4-1**)

Seat the SO-DIMM. Gently push downwards and the arms clip into place. (See **Figure 4-1**)

4.3.2 Motherboard Installation

To install the KINO-G410 motherboard into the chassis please refer to the reference material that came with the chassis.

4.4 Jumper Settings



NOTE:

A jumper is a metal bridge used to close an electrical circuit. It consists of two or three metal pins and a small metal clip (often protected by a plastic cover) that slides over the pins to connect them. To CLOSE/SHORT a jumper means connecting the pins of the jumper with the plastic clip and to OPEN a jumper means removing the plastic clip from a jumper.

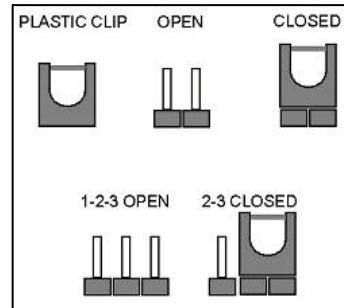

The KINO-PV-D5253/D4253 includes one jumper shown in **Table 4-1**.

Description	Label	Type
Clear CMOS jumper	J_CMOS1	3-pin header
USB6,7 power	J66	3-pin header
RS232/422/485 setting	JCOM61	6-pin header
RS422/485 TX setting	JCOM62	6-pin header

Table 4-1: Jumpers

4.4.1 Clear CMOS Jumper

Jumper Label: J_CMOS1
 Jumper Type: 3-pin header
 Jumper Settings: See **Table 4-2**
 Jumper Location: See **Figure 4-2**

To reset the BIOS, move the jumper to the "Clear BIOS" position for 3 seconds or more, and then move back to the default position.

Pin	Description
Short 1-2	Normal (Default)
Short 2-3	Clear BIOS

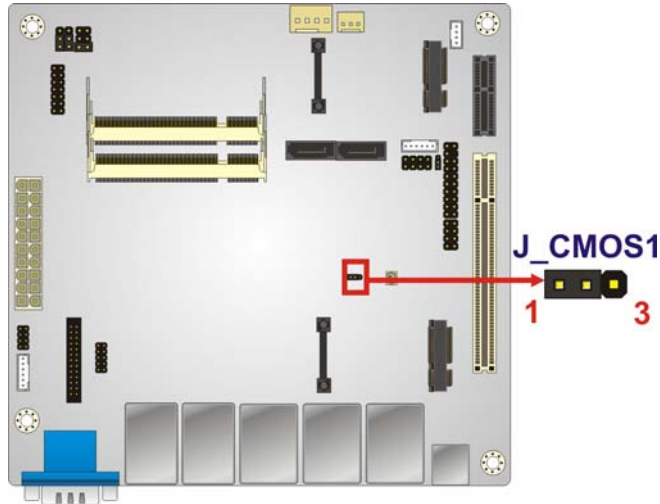
Table 4-2: Clear BIOS Jumper Settings

Figure 4-2: Clear BIOS Jumper Location

4.4.2 USB 6, 7 power Jumper

Jumper Label:	J66
Jumper Type:	3-pin header
Jumper Settings:	See Table 4-3
Jumper Location:	See Figure 4-3

Move the jumper to adjust USB input voltage..

Pin	Description
Short 1-2	VCC5DUAL
Short 2-3	VCC3DUAL

Table 4-3: USB6, 7 power Jumper Settings

KINO-PV-D5253-D4253 Mini-ITX Motherboard

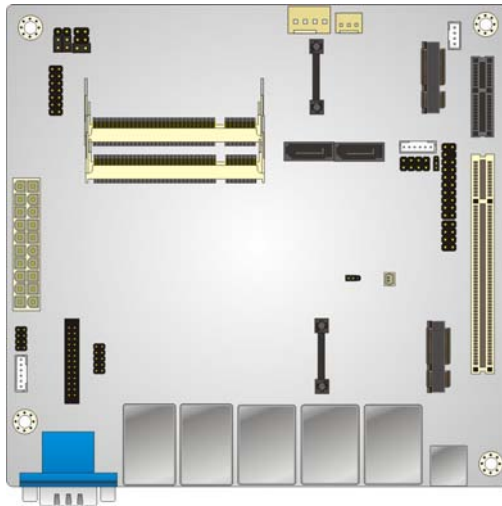

Figure 4-3: USB6, 7 power Jumper Location

4.4.3 COM 6 Function Select Jumper

Jumper Label:	JCOM61, JCOM62
Jumper Type:	6-pin header
Jumper Settings:	See Table 4-4
Jumper Location:	See Figure 4-4

The COM 6 Function Select jumper sets the communication protocol used by the second serial communications port (COM 6) as RS-232, RS-422 or RS-485. The COM 6 Function Select settings are shown in Table 4-4.

JCOM61 Setting		JCOM62 Setting	
Short 1-2	RS-232 (Default)	X	
Short 3-4	RS-422	Short 1-3, 2-4	RS-422(Default)
Short 5-6	RS-485	Short 3-5, 4-6	RS-485

Table 4-4: COM 6 Function Select Jumper Settings

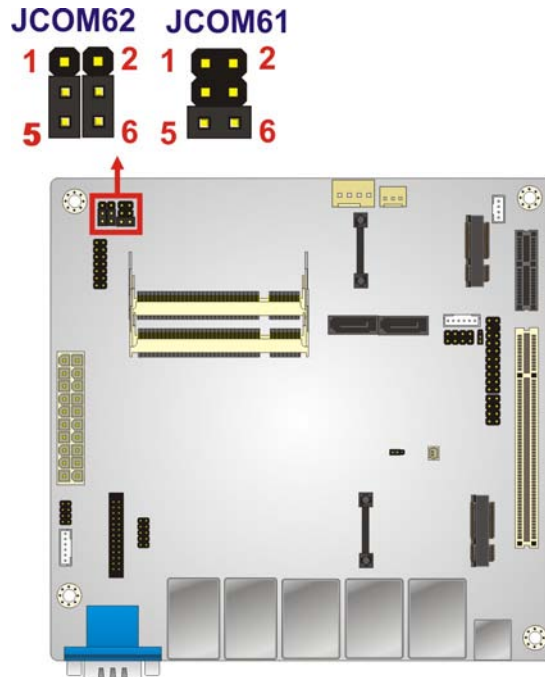

Figure 4-4: COM 6 Function Select Jumper Location

4.5 Internal Peripheral Device Connections

This section outlines the installation of peripheral devices to the onboard connectors.

4.5.1 SATA Drive Connection

The KINO-PV-D5253/D4253 is shipped with one SATA drive cables. To connect the SATA drives to the connectors, please follow the steps below.

Locate the connectors. The locations of the SATA drive connectors are shown in **Chapter 3**.

Insert the cable connector. Press the clip on the connector at the end of the SATA cable and insert the cable connector into the on-board SATA drive connector. See

Figure 4-5

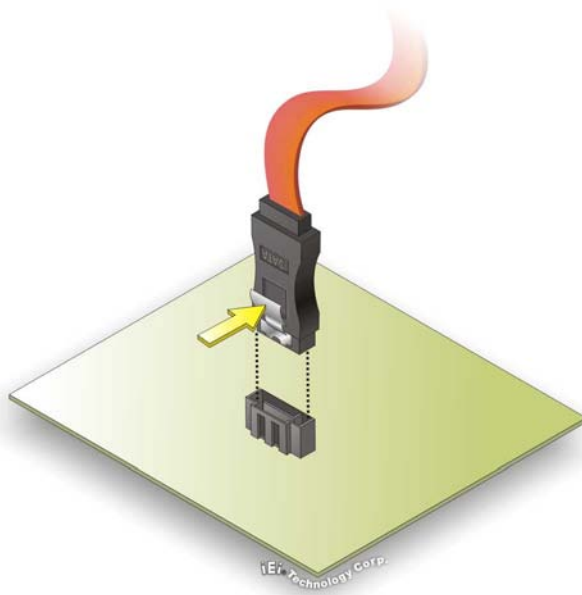

Figure 4-5: SATA Drive Cable Connection

Connect the cable to the SATA disk. Connect the connector on the other end of the cable to the connector at the back of the SATA drive. See **Figure 4-6**.

Connect the SATA power cable. Connect the SATA power connector to the back of the SATA drive. See **Figure 4-6**.

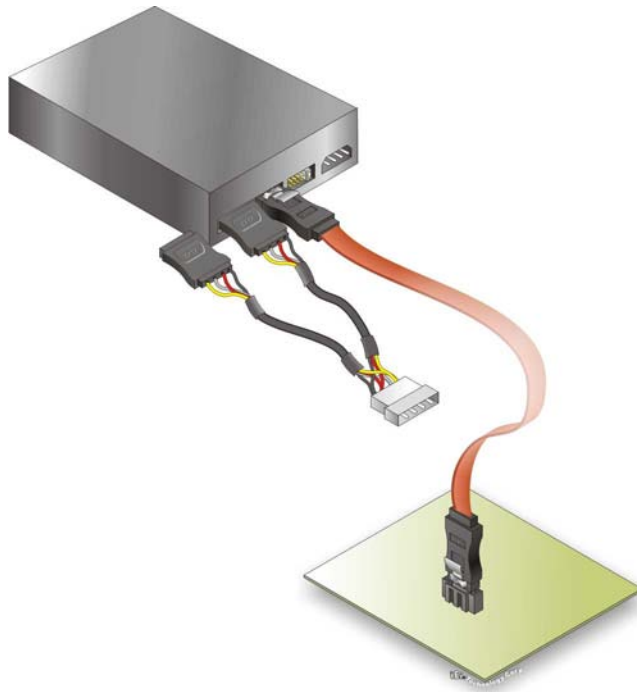

Figure 4-6: SATA Power Drive Connection

4.5.2 Single RS-232 Cable (w/o Bracket)

The single RS-232 cable consists of one serial port connector attached to a serial communications cable that is then attached to a D-sub 9 male connector. To install the single RS-232 cable, please follow the steps below.

Locate the connector. The location of the RS-232 connector is shown in **Chapter 3**.

Insert the cable connector. Insert the connector into the serial port box header. See

Figure 4-7. A key on the front of the cable connectors ensures the connector can only be installed in one direction.

KINO-PV-D5253-D4253 Mini-ITX Motherboard

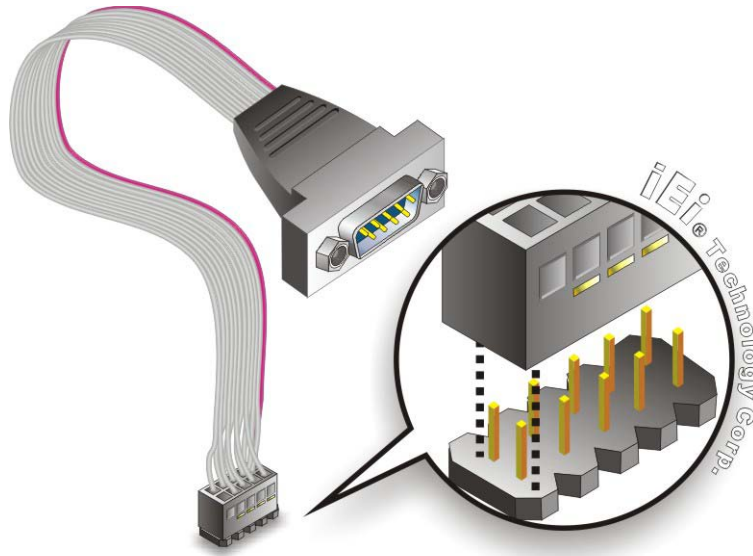

Figure 4-7: Single RS-232 Cable Installation

Secure the bracket. The single RS-232 connector has two retention screws that must be secured to a chassis or bracket.

Connect the serial device. Once the single RS-232 connector is connected to a chassis or bracket, a serial communications device can be connected to the system.

4.6 External Peripheral Interface Connection

This section describes connecting devices to the external connectors on the KINO-PV-D5253/D4253.

4.6.1 Audio Connector

The audio jacks on the external audio connector enable the KINO-PV-D5253/D4253 to be connected to a stereo sound setup. To install the audio devices, follow the steps below.

Identify the audio plugs. The plugs on your home theater system or speakers may not match the colors on the rear panel. If audio plugs are plugged into the wrong jacks, sound quality will be very bad.

Plug the audio plugs into the audio jacks. Plug the audio plugs into the audio jacks. If the plugs on your speakers are different, an adapter will need to be used to plug them into the audio jacks.

- **Line Out port (Lime):** Connects to a headphone or a speaker.
- **Microphone (Pink):** Connects to a microphone.

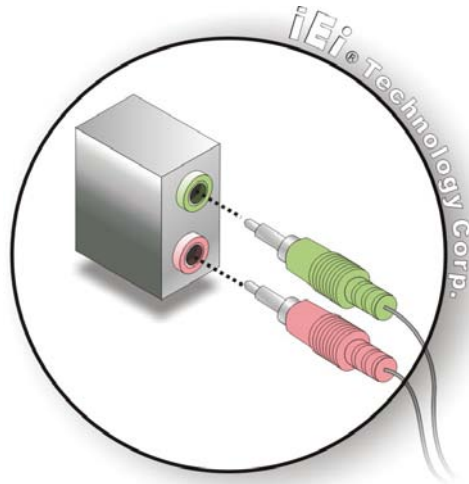

Figure 4-8: Audio Connector

Check audio clarity. Check that the sound is coming through the right speakers by adjusting the balance front to rear and left to right.

4.6.2 LAN Connection

There are two external RJ-45 LAN connectors. The RJ-45 connectors enable connection to an external network. To connect a LAN cable with an RJ-45 connector, please follow the instructions below.

Locate the RJ-45 connectors. The locations of the USB connectors are shown in **Chapter 4**.

Align the connectors. Align the RJ-45 connector on the LAN cable with one of the RJ-45 connectors on the KINO-PV-D5253/D4253. See **Figure 4-9**.

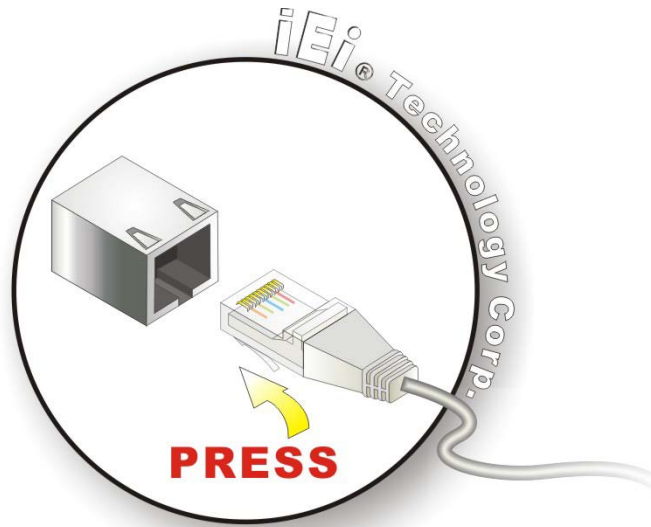

Figure 4-9: LAN Connection

Insert the LAN cable RJ-45 connector. Once aligned, gently insert the LAN cable RJ-45 connector into the on-board RJ-45 connector.

4.6.3 Serial Device Connection

The KINO-PV-D5253/D4253 has three male DB-9 connectors on the external peripheral interface panel for a serial device. Follow the steps below to connect a serial device to the KINO-PV-D5253/D4253.

Locate the DB-9 connector. The location of the DB-9 connector is shown in **Chapter 3**.

Insert the serial connector. Insert the DB-9 connector of a serial device into the DB-9 connector on the external peripheral interface. See **Figure 4-10**.

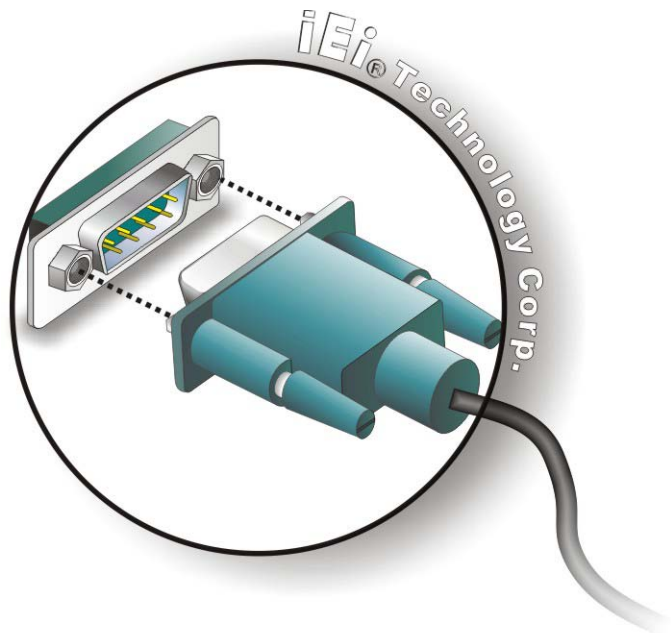

Figure 4-10: Serial Device Connector

Secure the connector. Secure the serial device connector to the external interface by tightening the two retention screws on either side of the connector.

4.6.4 USB Device Connection

The external USB Series "A" receptacle connectors provide easier and quicker access to external USB devices. Follow the steps below to connect USB devices to the KINO-PV-D5253/D4253.

Locate the USB Series "A" receptacle connectors. The location of the USB Series "A" receptacle connectors are shown in **Chapter 3**.

Insert a USB Series "A" plug. Insert the USB Series "A" plug of a device into the USB Series "A" receptacle on the external peripheral interface. See **Figure 4-11**.

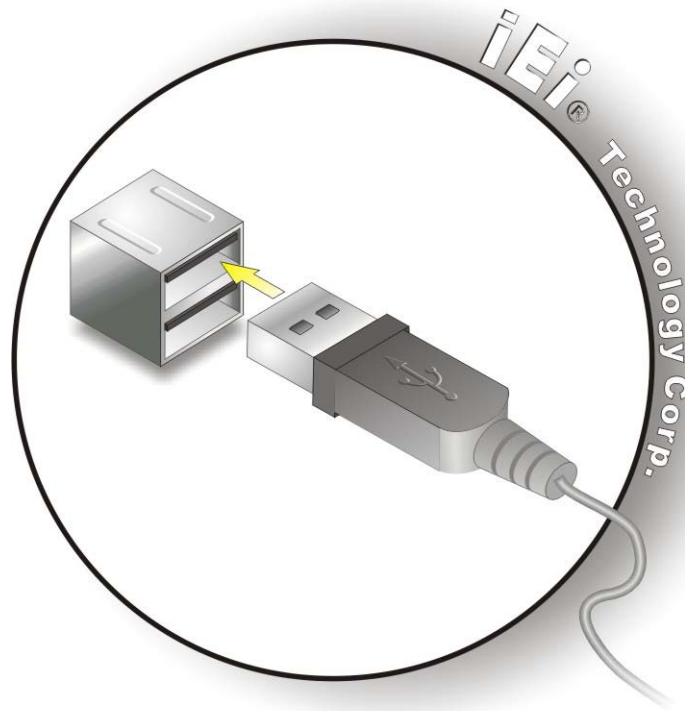

Figure 4-11: USB Connector

4.6.5 VGA Monitor Connection

The KINO-PV-D5253/D4253 has a single female DB-15 connector on the external peripheral interface panel. The DB-15 connector is connected to a CRT or VGA monitor. To connect a monitor to the KINO-PV-D5253/D4253, please follow the instructions below.

Locate the female DB-15 connector. The location of the female DB-15 connector is shown in **Chapter 3**.

Align the VGA connector. Align the male DB-15 connector on the VGA screen cable with the female DB-15 connector on the external peripheral interface.

Insert the VGA connector Once the connectors are properly aligned with the insert the male connector from the VGA screen into the female connector on the KINO-PV-D5253/D4253. See **Figure 4-12**.

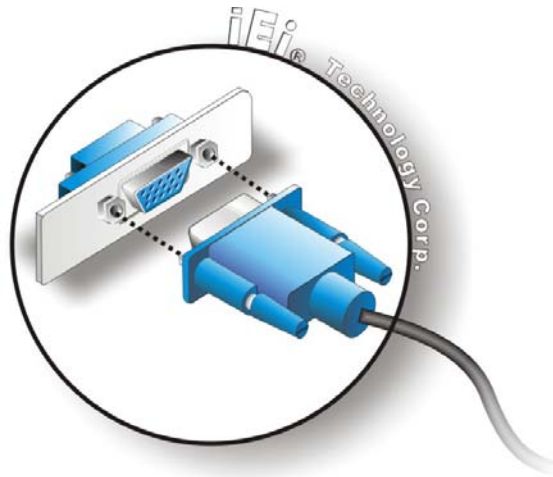

Figure 4-12: VGA Connector

Secure the connector. Secure the DB-15 VGA connector from the VGA monitor to the external interface by tightening the two retention screws on either side of the connector.

4.7 Software Installation

All the drivers for the KINO-PV-D5253/D4253 are on the CD that came with the system. To install the drivers, please follow the steps below.

Insert the CD into a CD drive connected to the system.



NOTE:

If the installation program doesn't start automatically:
Click "Start->My Computer->CD Drive->autorun.exe"

The driver main menu appears.

Click KINO-PV-D5253/D4253.

A new screen with a list of available drivers appears.

Install all of the necessary drivers in this menu.

Chapter

5

BIOS

5.1 Introduction

The BIOS is programmed onto the BIOS chip. The BIOS setup program allows changes to certain system settings. This chapter outlines the options that can be changed.

5.1.1 Starting Setup

The AMI BIOS is activated when the computer is turned on. The setup program can be activated in one of two ways.

1. Press the **DELETE** key as soon as the system is turned on or
2. Press the **DELETE** key when the “**Press Del to enter SETUP**” message appears on the screen.

If the message disappears before the **DELETE** key is pressed, restart the computer and try again.

5.1.2 Using Setup

Use the arrow keys to highlight items, press **ENTER** to select, use the PageUp and PageDown keys to change entries, press **F1** for help and press **ESC** to quit. Navigation keys are shown in.

Key	Function
Up arrow	Move to previous item
Down arrow	Move to next item
Left arrow	Move to the item on the left hand side
Right arrow	Move to the item on the right hand side
Esc key	Main Menu – Quit and not save changes into CMOS Status Page Setup Menu and Option Page Setup Menu -- Exit current page and return to Main Menu
F1 key	General help, only for Status Page Setup Menu and Option Page Setup Menu
F2 key	Load previous values.
F3 key	Load optimized defaults

Key	Function
F4 key	Save all the CMOS changes

Table 5-1: BIOS Navigation Keys

5.1.3 Getting Help

When **F1** is pressed a small help window describing the appropriate keys to use and the possible selections for the highlighted item appears. To exit the Help Window press **Esc** or the **F1** key again.

5.1.4 Unable to Reboot after Configuration Changes

If the computer cannot boot after changes to the system configuration is made, CMOS defaults. Use the jumper described in **Chapter 4**.

5.1.5 BIOS Menu Bar

The **menu bar** on top of the BIOS screen has the following main items:

- Main – Changes the basic system configuration.
- Advanced – Changes the advanced system settings.
- PCIPnP – Changes the advanced PCI/PnP Settings
- Boot – Changes the system boot configuration.
- Security – Sets User and Supervisor Passwords.
- Chipset – Changes the chipset settings.
- Power – Changes power management settings.
- Exit – Selects exit options and loads default settings

The following sections completely describe the configuration options found in the menu items at the top of the BIOS screen and listed above.

5.2 Main

The **Main** BIOS menu (**BIOS Menu 1**) appears when the **BIOS Setup** program is entered. The **Main** menu gives an overview of the basic system information.

```

Aptio Setup Utility - Copyright (C) 2010 American Megatrends, Inc.
Main  Advanced  Chipset  Boot  Security  Save & Exit

BIOS Information
BIOS Vendor                American Megatrends
Core Version                4.6.4.0 0.20
Compliancy                 UEFI 2.0
Project Version            SA33AR06.ROM
Build Date                 02/14/2011 13:50:21

System Date                [Tue 01/18/2011]
System Time                [14:20:27]

Access Level               Administrator

Set the Time. Use Tab to
switch between Time
elements.

-----

<=>: Select Screen
↑ ↓: Select Item
Enter>Select
F1  General Help
F2  Previous Values
F3  Optimized Defaults
F4  Save
ESC Exit

Version 2.02.1205. Copyright (C) 2010 American Megatrends, Inc.

```

BIOS Menu 1: Main

→ BIOS Information

The **BIOS Information** lists a brief summary of the BIOS. The fields in **BIOS Information** cannot be changed. The items shown in the system overview include:

- **BIOS Vendor:** Installed BIOS vendor
- **Core Version:** Current BIOS version
- **Project Version:** the board version
- **Build Date:** Date the current BIOS version was made

The System Overview field also has two user configurable fields:

→ System Date [xx/xx/xx]

Use the **System Date** option to set the system date. Manually enter the day, month and year.

KINO-PV-D5253-D4253 Mini-ITX Motherboard

→ System Time [xx:xx:xx]

Use the **System Time** option to set the system time. Manually enter the hours, minutes and seconds.

5.3 Advanced

Use the **Advanced** menu (**BIOS Menu 2**) to configure the CPU and peripheral devices through the following sub-menus:



WARNING!

Setting the wrong values in the sections below may cause the system to malfunction. Make sure that the settings made are compatible with the hardware.

```

Aptio Setup Utility - Copyright (C) 2010 American Megatrends, Inc.
Main  Advanced  Chipset  Boot  Security  Save & Exit

> ACPI Settings
> Trusted Computing
> CPU Configuration
> IDE Configuration
> USB Configuration
> Super IO Configuration
> H/M Monitor
> Serial Port Console Redirection

System ACPI Parameters
-----
<=>: Select Screen
↑ ↓: Select Item
Enter: Select
+/-: Change Opt.
F1  General Help
F2  Previous Values
F3  Optimized Defaults
F4  Save & Exit
ESC Exit

Version 2.02.1205. Copyright (C) 2010 American Megatrends, Inc.
  
```

BIOS Menu 2: Advanced

5.3.1 ACPI Settings

The **ACPI Settings** menu (**BIOS Menu 3**) configures the Advanced Configuration and Power Interface (ACPI) options.

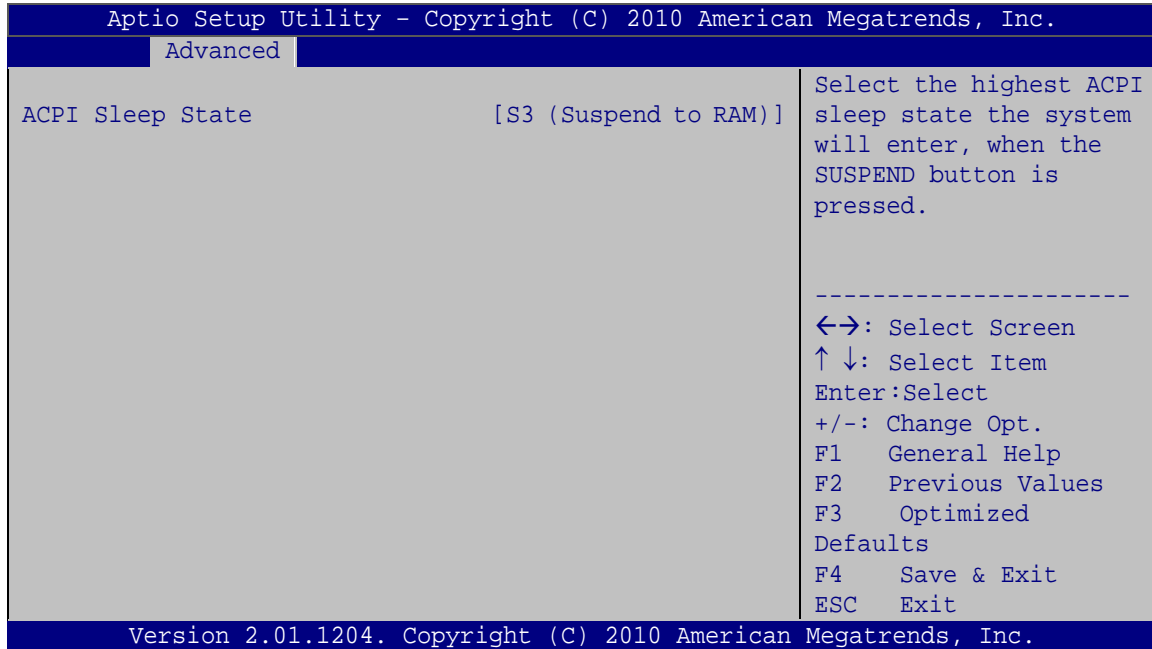

BIOS Menu 3: ACPI Settings

➔ **ACPI Sleep State [S3 (Suspend to RAM)]**

Use the **ACPI Sleep State** option to specify the sleep state the system enters when it is not being used.

➔ **Suspend Disabled**

➔ **S1 (CPU Stop Clock)**

The system enters S1(POS) sleep state. The system appears off. The CPU is stopped; RAM is refreshed; the system is running in a low power mode.

➔ **S3 (Suspend to DEFAULT RAM)**

The caches are flushed and the CPU is powered off. Power to the RAM is maintained. The computer returns slower to a working state, but more power is saved.

5.3.2 Trusted Computing

Use the **Trusted Computing** menu (**BIOS Menu 4**) to configure settings related to the Trusted Computing Group (TCG) Trusted Platform Module (TPM).

KINO-PV-D5253-D4253 Mini-ITX Motherboard

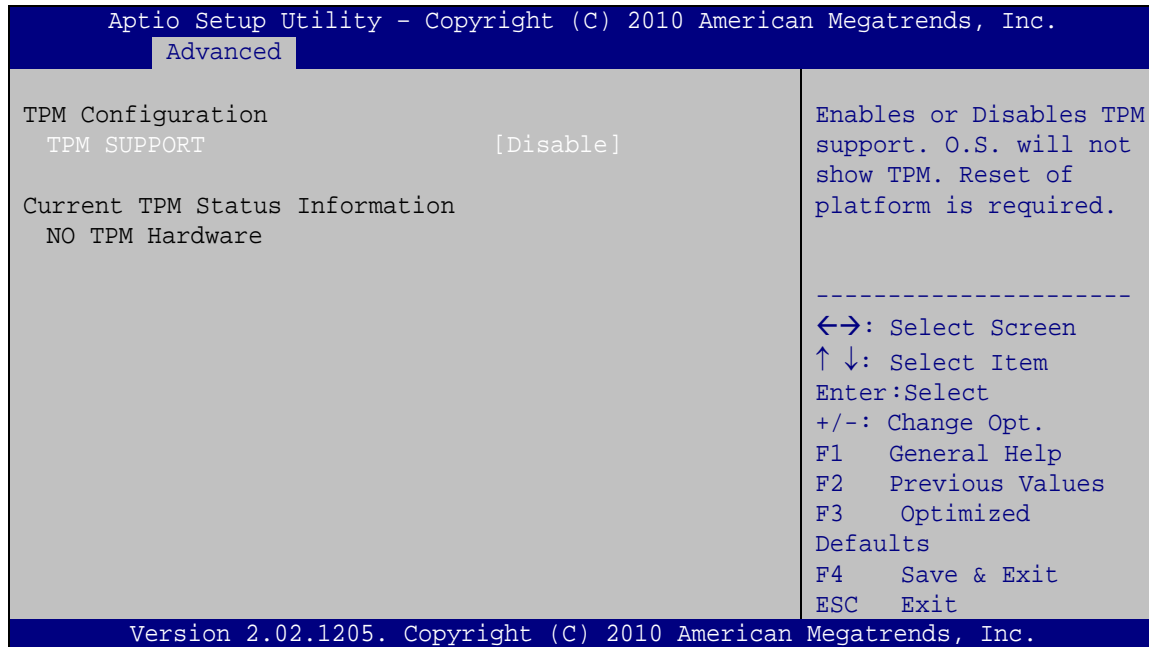

BIOS Menu 4: TPM Configuration

→ TPM Support [Disable]

Use the **TPM Support** option to configure support for the TPM.

→ **Disable** **DEFAULT** TPM support is disabled.

→ **Enable** TPM support is enabled.

5.3.3 CPU Configuration

Use the **CPU Configuration** menu (**BIOS Menu 5**) to view detailed CPU specifications and configure the CPU.

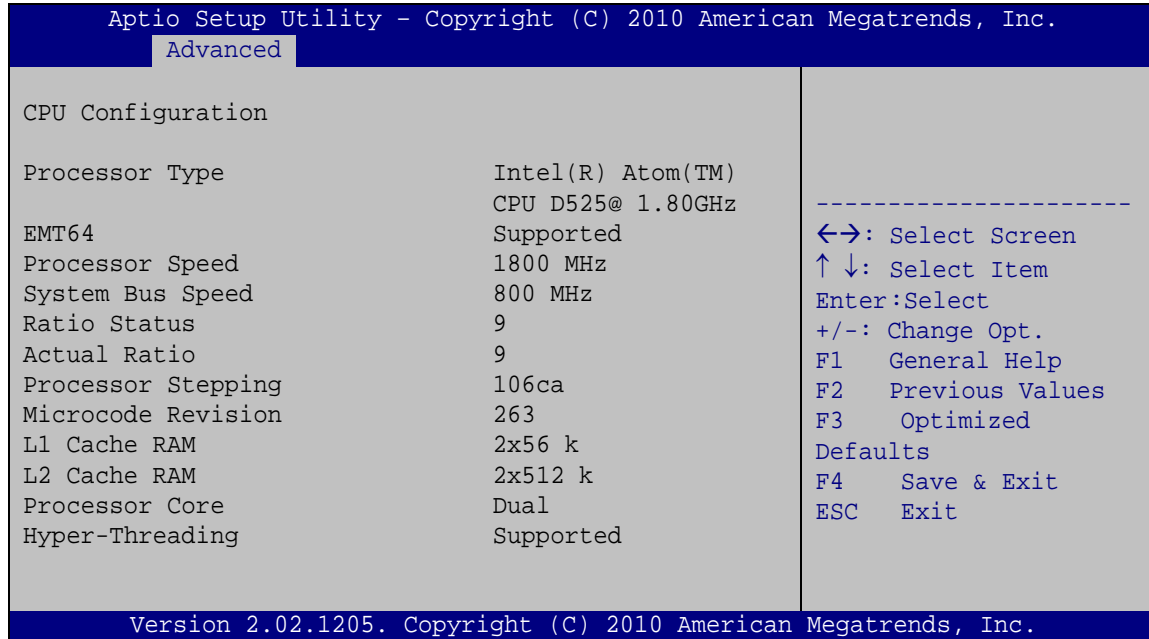

BIOS Menu 5: CPU Configuration

The CPU Configuration menu (**BIOS Menu 5**) lists the following CPU details:

- Processor Type: Lists the brand name of the CPU being used
- EMT64: Indicates if the EM64T is supported by the CPU.
- Processor Speed: Lists the CPU processing speed
- System Bus: Lists the system bus
- Ratio Status: List the maximum FSB divisor
- Actual Ratio: Lists current FSB divisor
- Processor Stepping: Lists the CPU processing stepping
- Microcode Revision: Lists the microcode revision
- L1 Cache RAM: Lists the CPU L1 cache size
- L2 Cache RAM: Lists the CPU L2 cache size
- Processor Core: Lists the number of the processor core
- Hyper-Threading: Indicates if the Intel Hyper-Threading Technology is supported by the CPU.

KINO-PV-D5253-D4253 Mini-ITX Motherboard

5.3.4 SATA Configuration

Use the **SATA Configuration** menu (**BIOS Menu 6**) to change and/or set the configuration of the SATA devices installed in the system.

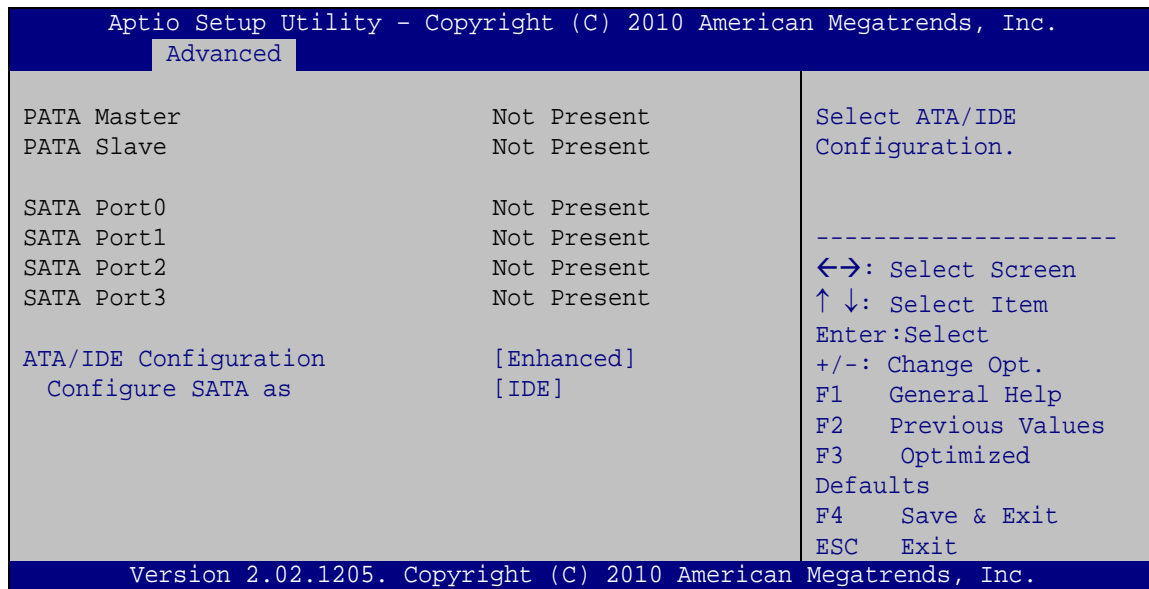

BIOS Menu 6: IDE Configuration

→ ATA/IDE Configurations [Enhanced]

Use the **ATA/IDE Configurations** option to configure the ATA/IDE controller.

- **Disabled** Disables the on-board ATA/IDE controller.
- **Compatible** Configures the on-board ATA/IDE controller to be in compatible mode. In this mode, a SATA channel will replace one of the IDE channels. This mode supports up to 4 storage devices.
- **Enhanced** **DEFAULT** Configures the on-board ATA/IDE controller to be in Enhanced mode. In this mode, IDE channels and SATA channels are separated. This mode supports up to 6 storage devices. Some legacy OS do not support this mode.

➔ Configure SATA as [IDE]

Use the **Configure SATA as** option to configure SATA devices as normal IDE devices.

➔ **IDE** **DEFAULT** Configures SATA devices as normal IDE device.

➔ **AHCI** Configures SATA devices as AHCI device.

5.3.5 USB Configuration

Use the **USB Configuration** menu (**BIOS Menu 7**) to read USB configuration information and configure the USB settings.

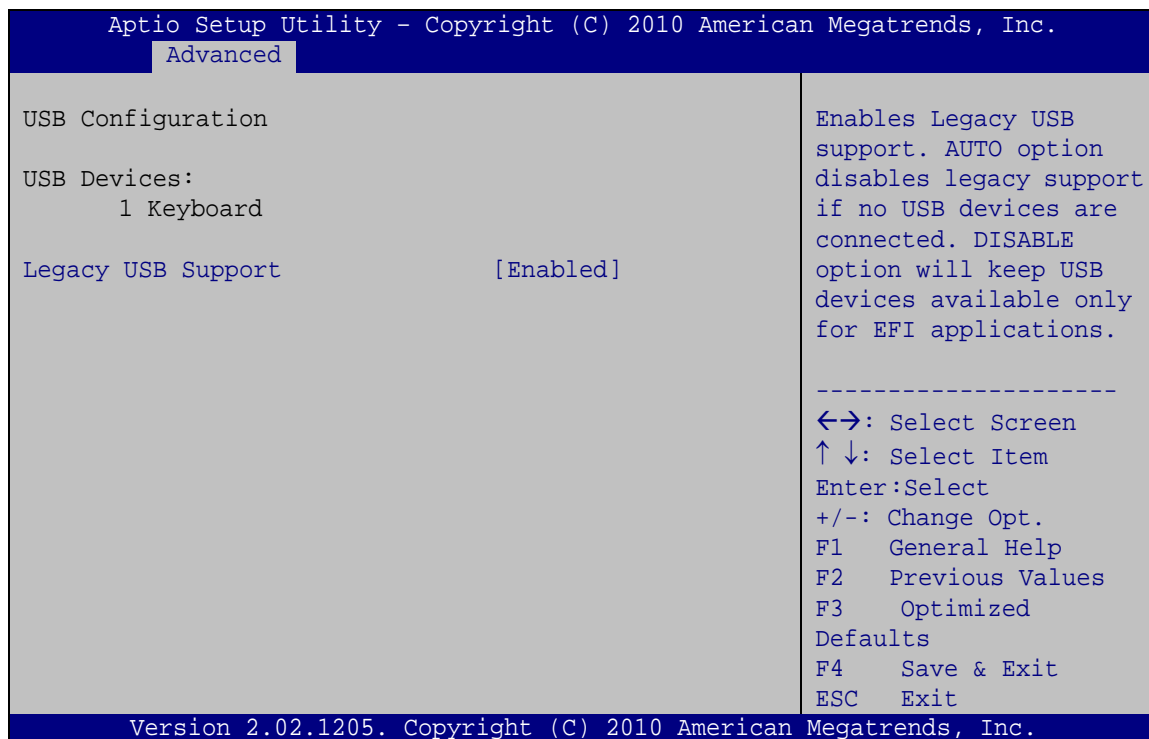

BIOS Menu 7: USB Configuration

➔ USB Devices

The **USB Devices Enabled** field lists the USB devices that are enabled on the system

KINO-PV-D5253-D4253 Mini-ITX Motherboard

➔ Legacy USB Support [Enabled]

Use the **Legacy USB Support** BIOS option to enable USB mouse and USB keyboard support. Normally if this option is not enabled, any attached USB mouse or USB keyboard does not become available until a USB compatible operating system is fully booted with all USB drivers loaded. When this option is enabled, any attached USB mouse or USB keyboard can control the system even when there is no USB driver loaded onto the system.

- ➔ **Enabled** **DEFAULT** Legacy USB support enabled
- ➔ **Disabled** Legacy USB support disabled
- ➔ **Auto** Legacy USB support disabled if no USB devices are connected

5.3.6 Super IO Configuration

Use the **Super IO Configuration** menu (**BIOS Menu 8**) to set or change the configurations for the FDD controllers, parallel ports and serial ports.

```

Aptio Setup Utility - Copyright (C) 2010 American Megatrends, Inc.
  Advanced
Super IO Configuration
Super IO Chip                Finteck F81865
> Serial Port 0 Configuration
> Serial Port 1 Configuration
> Serial Port 2 Configuration
> Serial Port 3 Configuration
> Serial Port 4 Configuration
> Serial Port 5 Configuration
> Parallel Port Configuration

Set Parameters of Serial
Port 0 (COMA)
-----
<->: Select Screen
↑ ↓: Select Item
Enter: Select
+/-: Change Opt.
F1  General Help
F2  Previous Values
F3  Optimized
Defaults
F4  Save & Exit
ESC Exit

Version 2.02.1205. Copyright (C) 2010 American Megatrends, Inc.
  
```

BIOS Menu 8: Super IO Configuration

5.3.6.1 Serial Port n Configuration

Use the **Serial Port n Configuration** menu (**BIOS Menu 9**) to configure the serial port n.

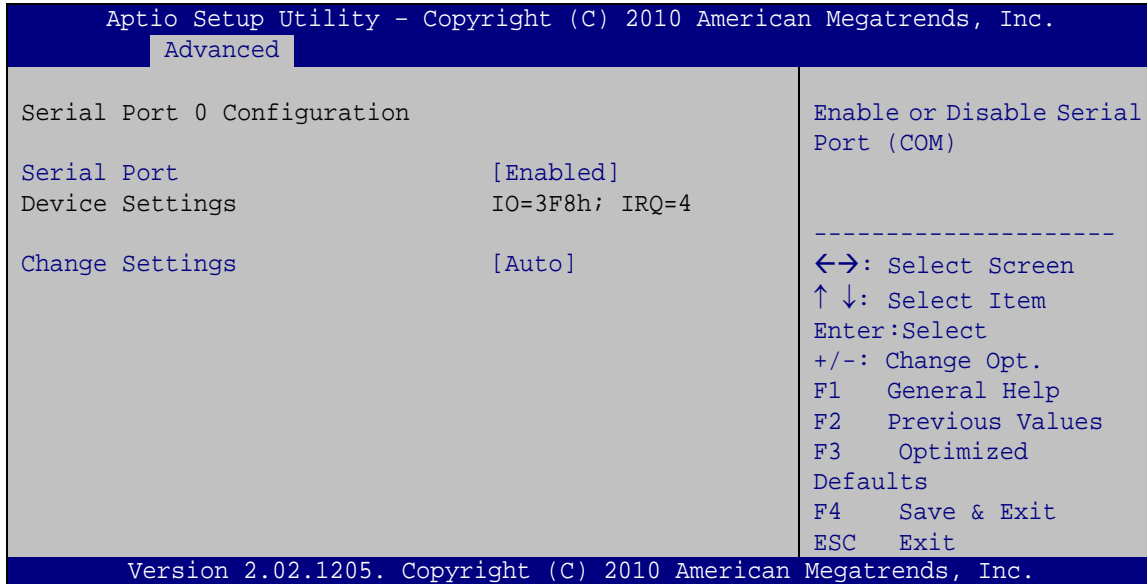

BIOS Menu 9: Serial Port n Configuration Menu

5.3.6.1.1 Serial Port 0 Configuration

→ Serial Port [Enabled]

Use the **Serial Port** option to enable or disable the serial port.

- **Disabled** Disable the serial port
- **Enabled** **DEFAULT** Enable the serial port

→ Change Settings [Auto]

Use the **Change Settings** option to change the serial port IO port address and interrupt address.

- **Auto** **DEFAULT** The serial port IO port address and interrupt address are automatically detected.

KINO-PV-D5253-D4253 Mini-ITX Motherboard

- ➔ **IO=3F8h;**
IRQ=4 Serial Port I/O port address is 3F8h and the interrupt address is IRQ4
- ➔ **IO=3F8h;**
IRQ=3, 4 Serial Port I/O port address is 3F8h and the interrupt address is IRQ3 and IRQ4
- ➔ **IO=2F8h;**
IRQ=3, 4 Serial Port I/O port address is 2F8h and the interrupt address is IRQ3 and IRQ4

5.3.6.1.2 Serial Port 1 Configuration

➔ Serial Port [Enabled]

Use the **Serial Port** option to enable or disable the serial port.

- ➔ **Disabled** Disable the serial port
- ➔ **Enabled** **DEFAULT** Enable the serial port

➔ Change Settings [Auto]

Use the **Change Settings** option to change the serial port IO port address and interrupt address.

- ➔ **Auto** **DEFAULT** The serial port IO port address and interrupt address are automatically detected.
- ➔ **IO=2F8h;**
IRQ=3 Serial Port I/O port address is 2F8h and the interrupt address is IRQ3
- ➔ **IO=3F8h;**
IRQ=3, 4 Serial Port I/O port address is 3F8h and the interrupt address is IRQ3 and IRQ4
- ➔ **IO=2F8h;**
IRQ=3, 4 Serial Port I/O port address is 2F8h and the interrupt address is IRQ3 and IRQ4

5.3.6.1.3 Serial Port 2 Configuration

→ Serial Port [Enabled]

Use the **Serial Port** option to enable or disable the serial port.

- **Disabled** Disable the serial port
- **Enabled** **DEFAULT** Enable the serial port

→ Change Settings [Auto]

Use the **Change Settings** option to change the serial port IO port address and interrupt address.

- **Auto** **DEFAULT** The serial port IO port address and interrupt address are automatically detected.
- **IO=3E8h;**
IRQ=6 Serial Port I/O port address is 3E8h and the interrupt address is IRQ6
- **IO=3E8h;**
IRQ=6 Serial Port I/O port address is 3E8h and the interrupt address is IRQ6
- **IO=2E8h;**
IRQ=6 Serial Port I/O port address is 2E8h and the interrupt address is IRQ6

5.3.6.1.4 Serial Port 3 Configuration

→ Serial Port [Enabled]

Use the **Serial Port** option to enable or disable the serial port.

- **Disabled** Disable the serial port
- **Enabled** **DEFAULT** Enable the serial port

→ Change Settings [Auto]

Use the **Change Settings** option to change the serial port IO port address and interrupt address.

KINO-PV-D5253-D4253 Mini-ITX Motherboard

- ➔ **Auto** **DEFAULT** The serial port IO port address and interrupt address are automatically detected.
- ➔ **IO=2F8h;**
IRQ=6 Serial Port I/O port address is 2F8h and the interrupt address is IRQ6
- ➔ **IO=3F8h;**
IRQ=6 Serial Port I/O port address is 3F8h and the interrupt address is IRQ6
- ➔ **IO=2F8h;**
IRQ=6 Serial Port I/O port address is 2F8h and the interrupt address is IRQ6

5.3.6.1.5 Serial Port 4 Configuration

➔ Serial Port [Enabled]

Use the **Serial Port** option to enable or disable the serial port.

- ➔ **Disabled** Disable the serial port
- ➔ **Enabled** **DEFAULT** Enable the serial port

➔ Change Settings [Auto]

Use the **Change Settings** option to change the serial port IO port address and interrupt address.

- ➔ **Auto** **DEFAULT** The serial port IO port address and interrupt address are automatically detected.
- ➔ **IO=2D0h;**
IRQ=6 Serial Port I/O port address is 2D0h and the interrupt address is IRQ6
- ➔ **IO=3D0h;**
IRQ=6 Serial Port I/O port address is 3D0h and the interrupt address is IRQ6
- ➔ **IO=2D8h;**
IRQ=6 Serial Port I/O port address is 2D8h and the interrupt address is IRQ6

5.3.6.1.6 Serial Port 5 Configuration

→ Serial Port [Enabled]

Use the **Serial Port** option to enable or disable the serial port.

- **Disabled** Disable the serial port
- **Enabled** **DEFAULT** Enable the serial port

→ Change Settings [Auto]

Use the **Change Settings** option to change the serial port IO port address and interrupt address.

- **Auto** **DEFAULT** The serial port IO port address and interrupt address are automatically detected.
- **IO=2D8h;**
IRQ=6 Serial Port I/O port address is 2D8h and the interrupt address is IRQ6
- **IO=3D0h;**
IRQ=6 Serial Port I/O port address is 3D0h and the interrupt address is IRQ6
- **IO=2D8h;**
IRQ=6 Serial Port I/O port address is 2D8h and the interrupt address is IRQ6

KINO-PV-D5253-D4253 Mini-ITX Motherboard

5.3.6.2 Parallel Port Configuration

Use the **Parallel Port Configuration** menu (**BIOS Menu 10**) to configure the serial port n.

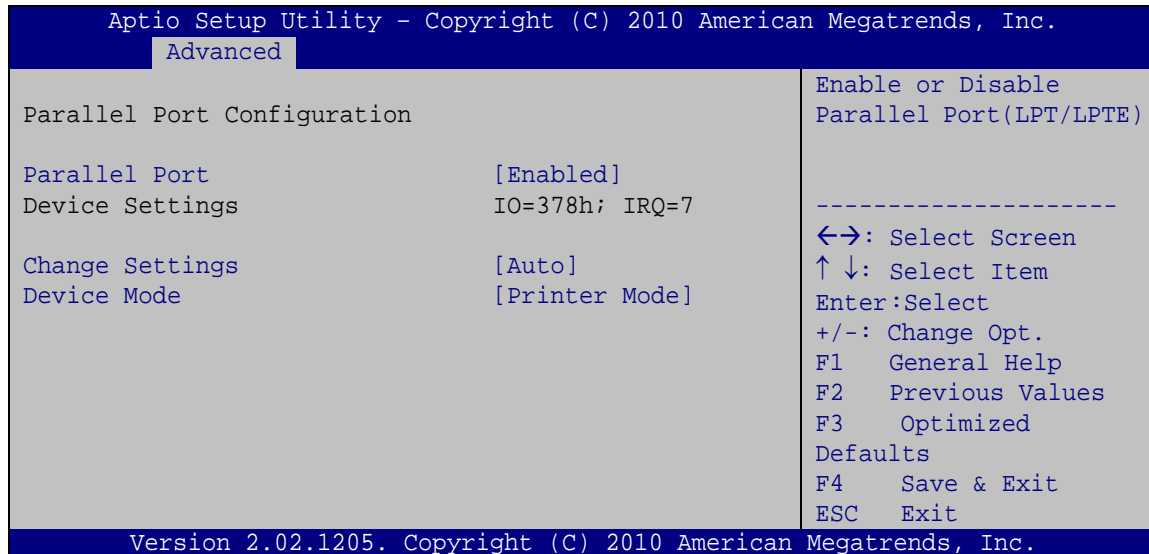

BIOS Menu 10: Parallel Port Configuration Menu

→ Parallel Port [Enabled]

Use the **Parallel Port** option to enable or disable the parallel port.

- **Disabled** Disable the parallel port
- **Enabled** **DEFAULT** Enable the parallel port

→ Change Settings [Auto]

Use the **Change Settings** option to change the parallel port IO port address and interrupt address.

- **Auto** **DEFAULT** The parallel port IO port address and interrupt address are automatically detected.
- **IO=378h;**
IRQ=7 Parallel Port I/O port address is 378h and the interrupt address is IRQ7
- **IO=278h;**
IRQ=7 Parallel Port I/O port address is 278h and the interrupt address is IRQ7

➔ **IO=3BCh;** Parallel Port I/O port address is 3BCh and the
IRQ=7 interrupt address is IRQ7

➔ Device Mode [Printer Mode]

Use the **Device Mode** option to select the mode the parallel port operates in. Configuration options are listed below.

- Printer Mode **Default**
- SPP Mode
- EPP-1.9 and SPP Mode
- EPP-1.7 and SPP Mode
- ECP Mode
- ECP and EPP 1.9 Mode
- ECP and EPP 1.7 Mode

5.3.7 H/W Monitor

The H/W Monitor menu (**BIOS Menu 11**) shows the operating temperature, fan speeds and system voltages.

```

Aptio Setup Utility - Copyright (C) 2010 American Megatrends, Inc.
-----
Advanced
-----
PC Health Status

CPU Temperature           :+49 C
SYS Temperature          :+61 C
CPU FAN Speed            :N/A
VCC3V                    :+3.344 V
V_core                   :+1.176 V
Vcc                      :+5.045 V
Vcc12                    :+12.144 V
V1_5VDDR                 :+1.600 V
VSB3V                    :+3.344 V
VBAT                     :+3.248 V
CPU Smart Fan control    [Auto Mode]
Temperature Bound1       60
Temperature Bound2       50
Temperature Bound3       40
Temperature Bound4       30

-----
<->: Select Screen
↑ ↓: Select Item
Enter: Select
+/-: Change Opt.
F1   General Help
F2   Previous Values
F3   Optimized
Defaults
F4   Save & Exit
ESC  Exit

Version 2.02.1205. Copyright (C) 2010 American Megatrends, Inc.
  
```

BIOS Menu 11: Hardware Health Configuration

KINO-PV-D5253-D4253 Mini-ITX Motherboard

→ PC Health Status

The following system parameters and values are shown. The system parameters that are monitored are:

- System Temperatures:
 - CPU Temperature
 - System Temperature
- Fan Speeds:
 - CPU Fan Speed
- Voltages:
 - V_core
 - Vcc
 - Vcc12
 - V1_5VDDR
 - VSB3V
 - VBAT

→ CPU Smart Fan control [Auto Mode]

Use the **CPU Smart Fan control** option to configure the CPU fan.

→ Auto Mode

The fan adjusts its speed using these settings:

Temperature Bound 1

Temperature Bound 2

Temperature Bound 3

Temperature Bound 4

→ Manual Mode

The fan spins at the speed set in:

Manual Duty Cycle Setting

5.3.8 Serial Port Console Redirection

The **Serial Port Console Redirection** menu (**BIOS Menu 14**) allows the console redirection options to be configured. Console redirection allows users to maintain a system remotely by re-directing keyboard input and text output through the serial port.

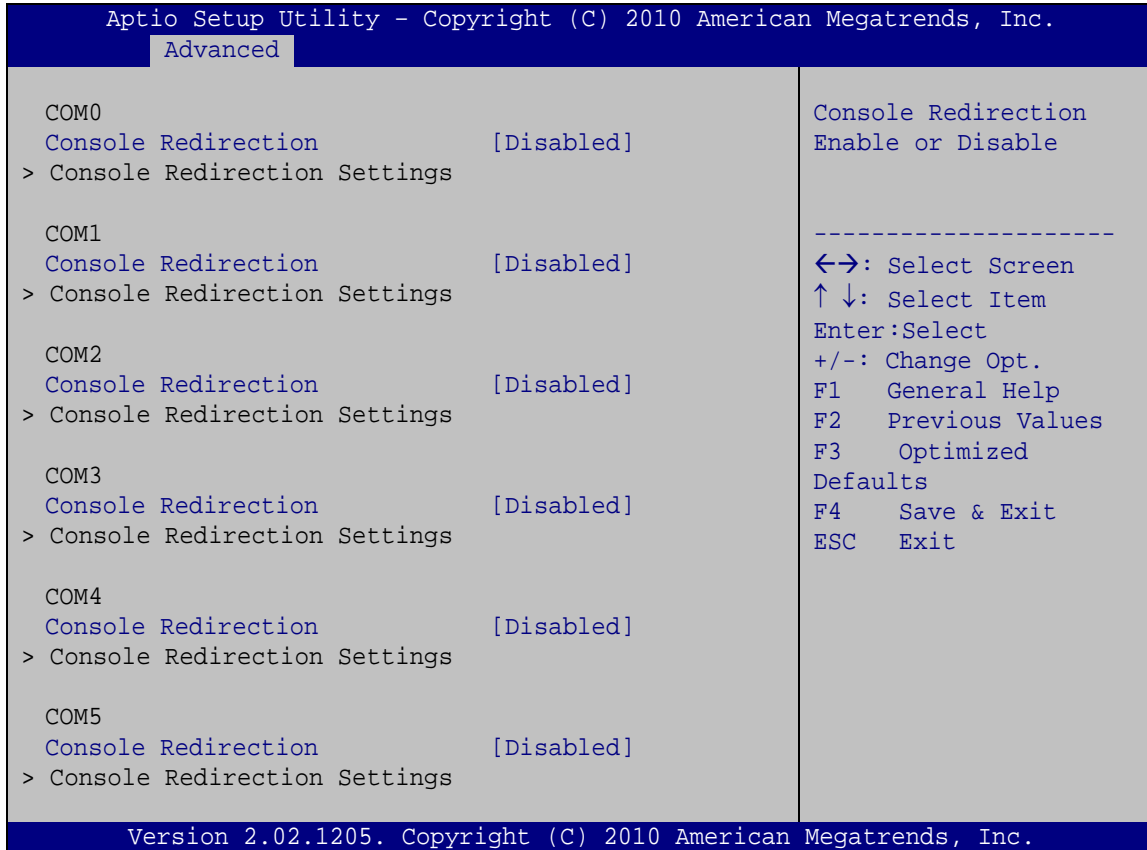

BIOS Menu 12: Serial Port Console Redirection

➔ Console Redirection [Disabled]

Use **Console Redirection** option to enable or disable the console redirection function.

- ➔ **Disabled** **DEFAULT** Disabled the console redirection function
- ➔ **Enabled** Enabled the console redirection function

5.4 Chipset

Use the **Chipset** menu (**BIOS Menu 15**) to access the Northbridge and Southbridge configuration menus



WARNING!

Setting the wrong values for the Chipset BIOS selections in the Chipset BIOS menu may cause the system to malfunction.

```
Aptio Setup Utility - Copyright (C) 2010 American Megatrends, Inc.
Main   Advanced  Chipset  Boot   Security  Save & Exit
-----
> Host Bridge
> South Bridge
> Intel IGD SWSCI OpRegion

South Bridge Parameters
-----
<=>: Select Screen
↑ ↓: Select Item
Enter: Select
+/-: Change Opt.
F1   General Help
F2   Previous Values
F3   Optimized
Defaults
F4   Save & Exit
ESC  Exit

Version 2.02.1205. Copyright (C) 2010 American Megatrends, Inc.
```

BIOS Menu 13: Chipset

5.4.1 Host Bridge Configuration

Use the **Host Bridge Configuration** menu (**BIOS Menu 16**) to configure the Northbridge chipset.

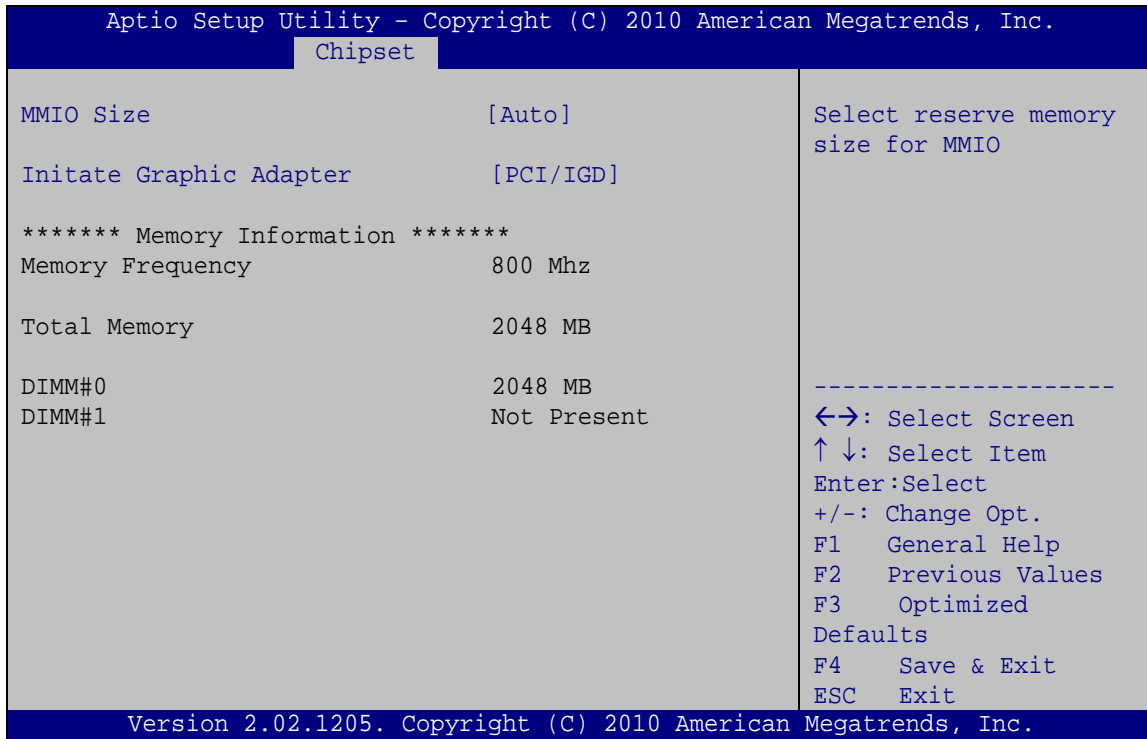

BIOS Menu 14: Host Bridge Chipset Configuration

➔ MMIO Size

Use the **MMIO** option to select reserved memory size for MMIO. Configuration options are listed below:

- AUTO DEFAULT
- 1GB
- 2GB

➔ Initiate Graphic Adapter

Use the **Initiate Graphic Adapter** option to select the graphics controller used as the primary boot device. Select either an integrated graphics controller (IGD) or a combination

KINO-PV-D5253-D4253 Mini-ITX Motherboard

of PCI graphics controller, a PCI express (PEG) controller or an IGD. Configuration options are listed below:

- IGD
- PEG/IGD DEFAULT

5.4.2 South Bridge Configuration

Use the **South Bridge Configuration** menu (**BIOS Menu 17**) to configure the Southbridge chipset.

```

Aptio Setup Utility - Copyright (C) 2010 American Megatrends, Inc.
Chipset
Restore AC Power Loss            [Power off]            HD Audio Controller
HD Audio Controller            [Enabled]
USB Function                    [Enabled]
USB 2.0(EHCI) Support          [Enabled]
Set Spread Spectrum function   [Disabled]
PCI-E Mini Card 1 Control       [Enabled]
PCI-E Mini Card 2 Control       [Enabled]
-----
<->: Select Screen
↑ ↓: Select Item
Enter: Select
+/-: Change Opt.
F1    General Help
F2    Previous Values
F3    Optimized
      Defaults
F4    Save & Exit
ESC   Exit
Version 2.02.1205. Copyright (C) 2010 American Megatrends, Inc.

```

BIOS Menu 15: South Bridge Chipset Configuration

➔ Restore on AC Power Loss [Last State]

Use the **Restore on AC Power Loss** BIOS option to specify what state the system returns to if there is a sudden loss of power to the system.

- ➔ **Power Off** The system remains turned off
- ➔ **Power On** The system turns on
- ➔ **Last State DEFAULT** The system returns to its previous state. If it was on, it turns itself on. If it was off, it remains off.

→ HD Audio Controller [Enabled]

Use the **HD Audio Controller** option to enable or disable the High Definition Audio controller.

→ **Enabled** **DEFAULT** The onboard High Definition Audio controller automatically detected and enabled

→ **Disabled** The onboard High Definition Audio controller is disabled

→ USB Function [Enabled]

Use the **USB Function** BIOS option to enable or disable USB function support.

→ **Disabled** USB function support disabled

→ **Enabled** **DEFAULT** USB function support enabled

→ USB 2.0 (EHCI) Support [Enabled]

Use the **USB 2.0 (EHCI) Support** BIOS option to enable or disable USB 2.0 support.

→ **Enabled** **DEFAULT** USB 2.0 (EHCI) support enabled

→ **Disabled** USB 2.0 (EHCI) support disabled

→ Set Spread Spectrum Function [Disabled]

The **Set Spread Spectrum Function** option can help to improve CPU EMI issues.

→ **Disabled** **DEFAULT** The spread spectrum mode is disabled

→ **Enabled** The spread spectrum mode is enabled

→ PCI-E Mini Card 1 Control [Enabled]

The PCI-E Mini Card 1 Control option can help to enable or disable Mini PCI-E support.

→ **Disabled** The spread spectrum mode is disabled

→ **Enabled** **DEFAULT** The spread spectrum mode is enabled

KINO-PV-D5253-D4253 Mini-ITX Motherboard

→ PCI-E Mini Card 2 Control [Enabled]

The PCI-E Mini Card 2 Control option can help to enable or disable Mini PCI-E support.

- **Disabled** The spread spectrum mode is disabled
- **Enabled DEFAULT** The spread spectrum mode is enabled

5.4.3 Intel IGD SWSCI OpRegion

Use the **Intel IGD SWSCI OpRegion** menu to configure the video device connected to the system.

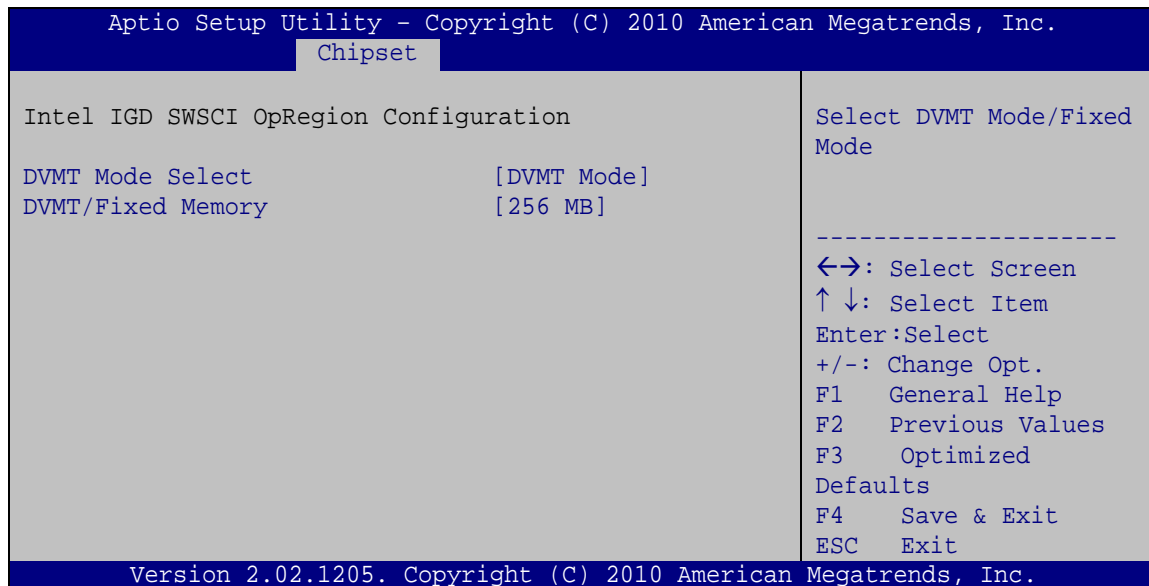

BIOS Menu 16: South Bridge Chipset Configuration

→ DVMT Mode Select [DVMT Mode]

Use the **DVMT Mode Select** option to select the Intel Dynamic Video Memory Technology (DVMT) operating mode.

- **Fixed Mode** A fixed portion of graphics memory is reserved as graphics memory.
- **DVMT Mode DEFAULT** Graphics memory is dynamically allocated according to the system and graphics needs.

➔ DVMT/FIXED Memory [256 MB]

Use the **DVMT/FIXED Memory** option to specify the maximum amount of memory that can be allocated as graphics memory. Configuration options are listed below.

- 128 MB
- 256 MB **Default**
- Maximum

5.5 Boot

Use the **Boot** menu (**BIOS Menu 19**) to configure system boot options.

```

Aptio Setup Utility - Copyright (C) 2010 American Megatrends, Inc.
Main   Advanced  Chipset  Boot   Security  Save & Exit
-----
Boot Configuration
Boot NumLock State           [On]
                               Select the keyboard
                               NumLock state

Quiet Boot                    [Enabled]
Launch PXE OpROM             [Disabled]

Boot Option Priorities
-----
<->: Select Screen
↑ ↓: Select Item
Enter: Select
+/-: Change Opt.
F1   General Help
F2   Previous Values
F3   Optimized
     Defaults
F4   Save & Exit
ESC  Exit

Version 2.02.1205. Copyright (C) 2010 American Megatrends, Inc.

```

BIOS Menu 17: Boot

➔ Bootup NumLock State [On]

Use the **Bootup NumLock State** BIOS option to specify if the number lock setting must be modified during boot up.

KINO-PV-D5253-D4253 Mini-ITX Motherboard

→ **On** **DEFAULT** Allows the Number Lock on the keyboard to be enabled automatically when the computer system boots up. This allows the immediate use of the 10-key numeric keypad located on the right side of the keyboard. To confirm this, the Number Lock LED light on the keyboard is lit.

→ **Off** Does not enable the keyboard Number Lock automatically. To use the 10-keys on the keyboard, press the Number Lock key located on the upper left-hand corner of the 10-key pad. The Number Lock LED on the keyboard lights up when the Number Lock is engaged.

→ Quiet Boot [Enabled]

Use the **Quiet Boot** BIOS option to select the screen display when the system boots.

→ **Disabled** Normal POST messages displayed

→ **Enabled** **DEFAULT** OEM Logo displayed instead of POST messages

→ Launch PXE OpROM [Disabled]

Use the **Launch PXE OpROM** option to enable or disable boot option for legacy network devices.

→ **Disabled** **DEFAULT** Ignore all PXE Option ROMs

→ **Enabled** Load PXE Option ROMs.

5.6 Security

Use the **Security** menu (**BIOS Menu 20**) to set system and user passwords.

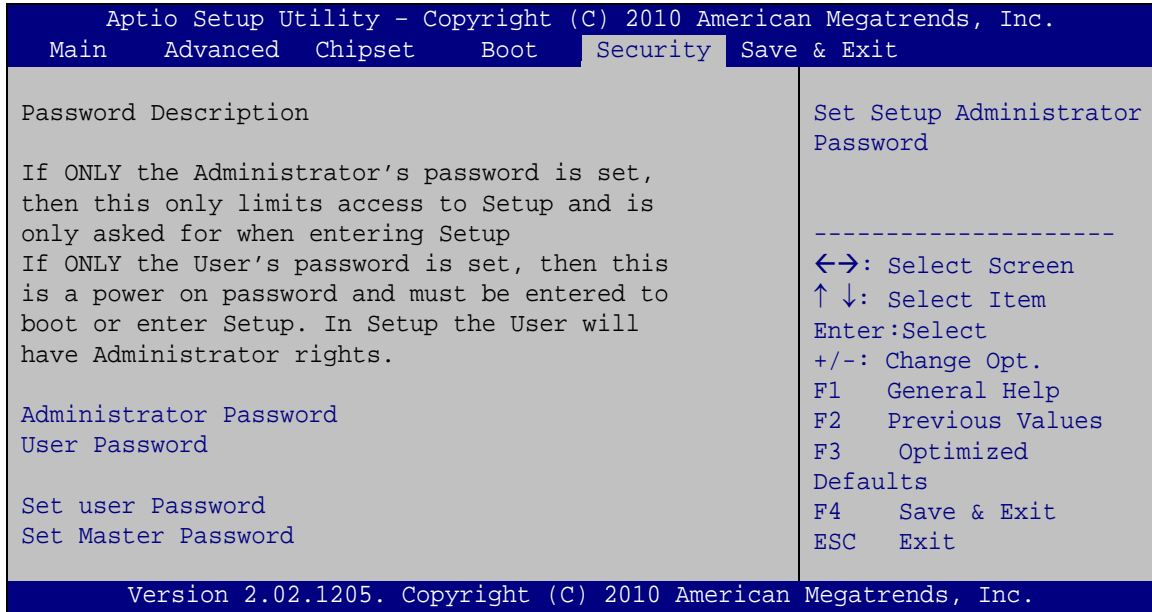
BIOS Menu 18: Security
➔ Administrator Password

Use the **Administrator Password** to set or change a administrator password.

➔ User Password

Use the **User Password** to set or change a user password.

➔ Set User Password

Use HDD **User Password** to set or change a HDD password.

5.7 Save&Exit

Use the Exit menu (**BIOS Menu 21**) to load default BIOS values, optimal failsafe values and to save configuration changes.

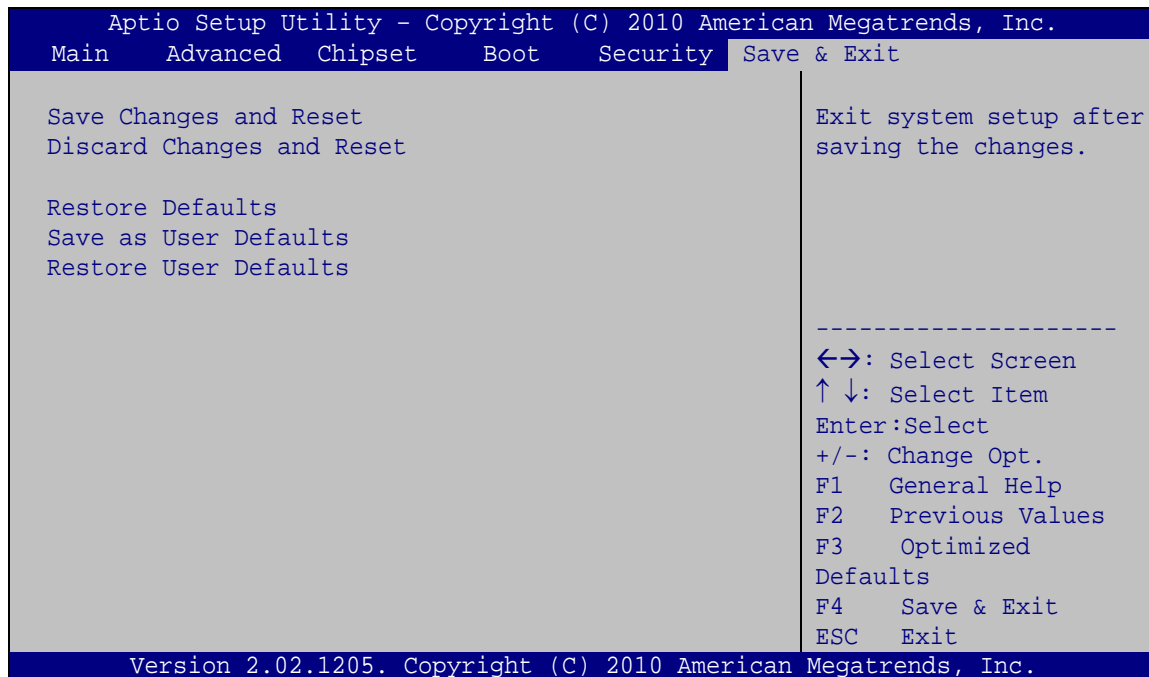

BIOS Menu 19:Exit

➔ Save Changes and Reset

Use the **Save Changes and Reset** option to save the changes made to the BIOS options and to exit the BIOS configuration setup program.

➔ Discard Changes and Reset

Use the **Discard Changes and Reset** option to exit the system without saving the changes made to the BIOS configuration setup program.

➔ Restore Defaults

Use the **Restore Defaults** option to load the optimal default values for each of the parameters on the Setup menus. **F3 key can be used for this operation.**



→ Save as User Defaults

Use the **Save as User Defaults** option to save the changes done so far as user defaults.

→ Restore User Defaults

Use the **Restore User Defaults** option to restore the user defaults to all the setup options.

Appendix

A

BIOS Options

Below is a list of BIOS configuration options in the BIOS chapter.

➔ BIOS Information	56
➔ System Date [xx/xx/xx]	56
➔ System Time [xx:xx:xx]	57
➔ ACPI Sleep State [S3 (Suspend to RAM)]	58
➔ TPM Support [Disable]	59
➔ ATA/IDE Configurations [Enhanced]	61
➔ Configure SATA as [IDE]	62
➔ USB Devices	62
➔ Legacy USB Support [Enabled]	63
➔ Serial Port [Enabled]	64
➔ Change Settings [Auto]	64
➔ Serial Port [Enabled]	65
➔ Change Settings [Auto]	65
➔ Serial Port [Enabled]	66
➔ Change Settings [Auto]	66
➔ Serial Port [Enabled]	66
➔ Change Settings [Auto]	66
➔ Serial Port [Enabled]	67
➔ Change Settings [Auto]	67
➔ Serial Port [Enabled]	68
➔ Change Settings [Auto]	68
➔ Parallel Port [Enabled]	69
➔ Change Settings [Auto]	69
➔ Device Mode [Printer Mode]	70
➔ PC Health Status	71
➔ CPU Smart Fan control [Auto Mode]	71
➔ Console Redirection [Disabled]	72
➔ MMIO Size	74
➔ Initiate Graphic Adapter	74
➔ Restore on AC Power Loss [Last State]	75
➔ HD Audio Controller [Enabled]	76
➔ USB Function [Enabled]	76
➔ USB 2.0 (EHCI) Support [Enabled]	76

KINO-PV-D5253-D4253 Mini-ITX Motherboard

➔ Set Spread Spectrum Function [Disabled].....	76
➔ PCI-E Mini Card 1 Control [Enabled].....	76
➔ PCI-E Mini Card 2 Control [Enabled].....	77
➔ DVMT Mode Select [DVMT Mode].....	77
➔ DVMT/FIXED Memory [256 MB]	78
➔ Bootup NumLock State [On].....	78
➔ Quiet Boot [Enabled]	79
➔ Launch PXE OpROM [Disabled]	79
➔ Administrator Password	80
➔ User Password	80
➔ Set User Password	80
➔ Save Changes and Reset	81
➔ Discard Changes and Reset	81
➔ Restore Defaults	81
➔ Save as User Defaults	82
➔ Restore User Defaults	82



Appendix

B

Terminology

KINO-PV-D5253-D4253 Mini-ITX Motherboard

AC '97	Audio Codec 97 (AC'97) refers to a codec standard developed by Intel® in 1997.
ACPI	Advanced Configuration and Power Interface (ACPI) is an OS-directed configuration, power management, and thermal management interface.
AHCI	Advanced Host Controller Interface (AHCI) is a SATA Host controller register-level interface.
ATA	The Advanced Technology Attachment (ATA) interface connects storage devices including hard disks and CD-ROM drives to a computer.
ARMD	An ATAPI Removable Media Device (ARMD) is any ATAPI device that supports removable media, besides CD and DVD drives.
ASKIR	Amplitude Shift Keyed Infrared (ASKIR) is a form of modulation that represents a digital signal by varying the amplitude (“volume”) of the signal. A low amplitude signal represents a binary 0, while a high amplitude signal represents a binary 1.
BIOS	The Basic Input/Output System (BIOS) is firmware that is first run when the computer is turned on and can be configured by the end user
CODEC	The Compressor-Decompressor (CODEC) encodes and decodes digital audio data on the system.
CMOS	Complimentary metal-oxide-conductor is an integrated circuit used in chips like static RAM and microprocessors.
COM	COM refers to serial ports. Serial ports offer serial communication to expansion devices. The serial port on a personal computer is usually a male DB-9 connector.
DAC	The Digital-to-Analog Converter (DAC) converts digital signals to analog signals.
DDR	Double Data Rate refers to a data bus transferring data on both the rising and falling edges of the clock signal.
DMA	Direct Memory Access (DMA) enables some peripheral devices to bypass the system processor and communicate directly with the system memory.

DIMM	Dual Inline Memory Modules are a type of RAM that offer a 64-bit data bus and have separate electrical contacts on each side of the module.
DIO	The digital inputs and digital outputs are general control signals that control the on/off circuit of external devices or TTL devices. Data can be read or written to the selected address to enable the DIO functions.
EHCI	The Enhanced Host Controller Interface (EHCI) specification is a register-level interface description for USB 2.0 Host Controllers.
EIDE	Enhanced IDE (EIDE) is a newer IDE interface standard that has data transfer rates between 4.0 MBps and 16.6 MBps.
EIST	Enhanced Intel® SpeedStep Technology (EIST) allows users to modify the power consumption levels and processor performance through application software. The application software changes the bus-to-core frequency ratio and the processor core voltage.
FSB	The Front Side Bus (FSB) is the bi-directional communication channel between the processor and the Northbridge chipset.
GbE	Gigabit Ethernet (GbE) is an Ethernet version that transfers data at 1.0 Gbps and complies with the IEEE 802.3-2005 standard.
GPIO	General purpose input
HDD	Hard disk drive (HDD) is a type of magnetic, non-volatile computer storage device that stores digitally encoded data.
ICH	The Input/Output Control Hub (ICH) is an Intel® Southbridge chipset.
IrDA	Infrared Data Association (IrDA) specify infrared data transmission protocols used to enable electronic devices to wirelessly communicate with each other.
L1 Cache	The Level 1 Cache (L1 Cache) is a small memory cache built into the system processor.
L2 Cache	The Level 2 Cache (L2 Cache) is an external processor memory cache.
LCD	Liquid crystal display (LCD) is a flat, low-power display device that consists of two polarizing plates with a liquid crystal panel in between.

KINO-PV-D5253-D4253 Mini-ITX Motherboard

LVDS	Low-voltage differential signaling (LVDS) is a dual-wire, high-speed differential electrical signaling system commonly used to connect LCD displays to a computer.
POST	The Power-on Self Test (POST) is the pre-boot actions the system performs when the system is turned-on.
RAM	Random Access Memory (RAM) is volatile memory that loses data when power is lost. RAM has very fast data transfer rates compared to other storage like hard drives.
SATA	Serial ATA (SATA) is a serial communications bus designed for data transfers between storage devices and the computer chipsets. The SATA bus has transfer speeds up to 1.5 Gbps and the SATA II bus has data transfer speeds of up to 3.0 Gbps.
S.M.A.R.T	Self Monitoring Analysis and Reporting Technology (S.M.A.R.T) refers to automatic status checking technology implemented on hard disk drives.
UART	Universal Asynchronous Receiver-transmitter (UART) is responsible for asynchronous communications on the system and manages the system's serial communication (COM) ports.
UHCI	The Universal Host Controller Interface (UHCI) specification is a register-level interface description for USB 1.1 Host Controllers.
USB	The Universal Serial Bus (USB) is an external bus standard for interfacing devices. USB 1.1 supports 12Mbps data transfer rates and USB 2.0 supports 480Mbps data transfer rates.
VGA	The Video Graphics Array (VGA) is a graphics display system developed by IBM.

Appendix

C

One Key Recovery

C.1 One Key Recovery Introduction

The IEI one key recovery is an easy-to-use front end for the Norton Ghost system backup and recovery tool. The one key recovery provides quick and easy shortcuts for creating a backup and reverting to that backup or for reverting to the factory default settings.

The IEI One Key Recovery tool menu is shown below.

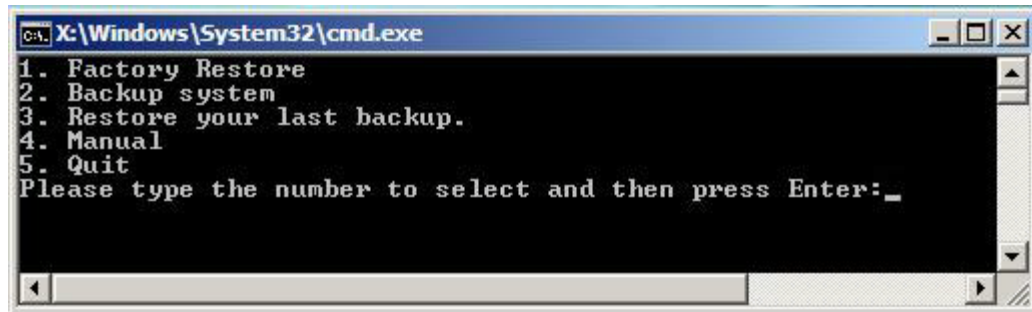

Figure C-1: IEI One Key Recovery Tool Menu

Prior to using the IEI One Key Recovery tool (as shown in **Figure C-1**) to backup or restore Windows system, five setup procedures are required.

1. Hardware and BIOS setup (see **Section C.2.1**)
2. Create partitions (see **Section C.2.2**)
3. Install operating system, drivers and system applications (see **Section C.2.3**)
4. Build-up recovery partition (see **Section C.2.4**)
5. Create factory default image (see **Section C.2.5**)

After completing the five initial setup procedures as described above, users can access the recovery tool by pressing <F3> while booting up the system. The detailed information of each function is described in **Section C.4**.



NOTE:

The initial setup procedures for Linux system are described in **Section C.3**.

C.1.1 System Requirement

NOTE:

The recovery CD can only be used with IEI products. The software will fail to run and a warning message will appear when used on non-IEI hardware.

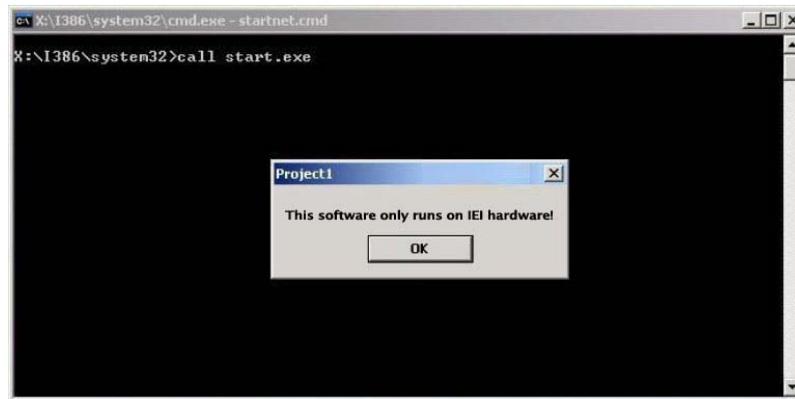

To create the system backup, the main storage device must be split into two partitions (three partitions for Linux). The first partition will be for the operating system, while the second partition will be invisible to the operating system and contain the backup made by the one key recovery software.

The partition created for recovery images must be big enough to contain both the factory default image and the user backup image. The size must be calculated before creating the partitions. Please take the following table as a reference when calculating the size of the partition.

	OS	OS Image after Ghost	Compression Ratio
Windows® 7	7 GB	5 GB	70%
Windows® XPE	776 MB	560 MB	70%
Windows® CE 6.0	36 MB	28 MB	77%

**NOTE:**

Specialized tools are required to change the partition size if the operating system is already installed.

C.1.2 Supported Operating System

The recovery CD is compatible with both Microsoft Windows and Linux operating system (OS). The supported OS versions are listed below.

- Microsoft Windows
 - Windows XP (Service Pack 2 or 3 required)
 - Windows Vista
 - Windows 7
 - Windows CE 5.0
 - Windows CE 6.0
 - Windows XP Embedded
- Linux
 - Fedora Core 12 (Constantine)
 - Fedora Core 11 (Leonidas)
 - Fedora Core 10 (Cambridge)
 - Fedora Core 8 (Werewolf)
 - Fedora Core 7 (Moonshine)
 - RedHat RHEL-5.4
 - RedHat 9 (Ghirke)
 - Ubuntu 8.10 (Intrepid)
 - Ubuntu 7.10 (Gutsy)
 - Ubuntu 6.10 (Edgy)
 - Debian 5.0 (Lenny)
 - Debian 4.0 (Etch)
 - SuSe 11.2
 - SuSe 10.3

**NOTE:**

Installing unsupported OS versions may cause the recovery tool to fail.

C.2 Setup Procedure for Windows

Prior to using the recovery tool to backup or restore Windows system, a few setup procedures are required.

Hardware and BIOS setup (see **Section C.2.1**)

Create partitions (see **Section C.2.2**)

Install operating system, drivers and system applications (see **Section C.2.3**)

Build-up recovery partition (see **Section C.2.4**)

Create factory default image (see **Section C.2.5**)

The detailed descriptions are described in the following sections.

**NOTE:**

The setup procedures described below are for Microsoft Windows operating system users. For Linux system, most setup procedures are the same with Microsoft Windows except for several steps which is described in **Section C.3**.

C.2.1 Hardware and BIOS Setup

Make sure the system is powered off and unplugged.

Install a hard drive or SSD in the system. An unformatted and unpartitioned disk is recommended.

Connect an optical disk drive to the system and insert the recovery CD.

KINO-PV-D5253-D4253 Mini-ITX Motherboard

Turn on the system.

Press the <DELETE> key as soon as the system is turned on to enter the BIOS.

Select the connected optical disk drive as the 1st boot device. (**Boot → Boot Device Priority → 1st Boot Device**).

Save changes and restart the computer. Continue to the next section for instructions on partitioning the internal storage.

C.2.2 Create Partitions

To create the system backup, the main storage device must be split into two partitions (three partitions for Linux). The first partition will be for the operating system, while the second partition will be invisible to the operating system and contain the backup made by the one key recovery software.

Put the recovery CD in the optical drive of the system.

Boot the system from recovery CD. When prompted, press any key to boot from the recovery CD. It will take a while to launch the recovery tool. Please be patient!

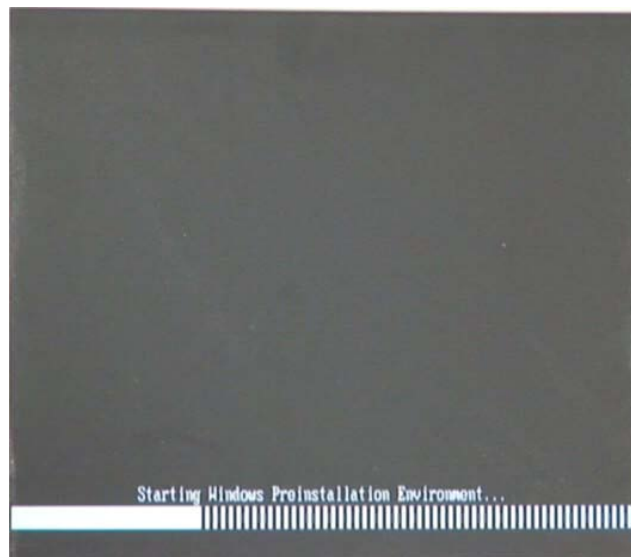
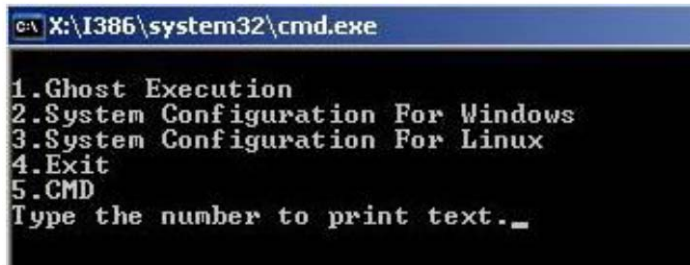

Figure C-2: Launching the Recovery Tool

The recovery tool setup menu is shown as below.



```

C:\X:\I386\system32\cmd.exe

1.Ghost Execution
2.System Configuration For Windows
3.System Configuration For Linux
4.Exit
5.CMD
Type the number to print text._
    
```

Figure C-3: Recovery Tool Setup Menu

Press <5> then <Enter>.

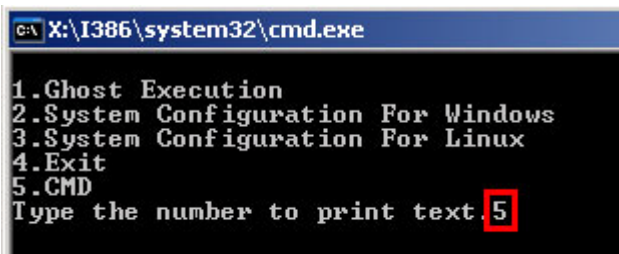

```

C:\X:\I386\system32\cmd.exe

1.Ghost Execution
2.System Configuration For Windows
3.System Configuration For Linux
4.Exit
5.CMD
Type the number to print text.5
    
```

Figure C-4: Command Mode

The command prompt window appears. Type the following commands (marked in red) to create two partitions. One is for the OS installation; the other is for saving recovery files and images which will be an invisible partition.

(Press <Enter> after entering each line below)

```

system32>diskpart
DISKPART>list vol
DISKPART>sel disk 0
DISKPART>create part pri size= ____
DISKPART>assign letter=N
DISKPART>create part pri size= ____
DISKPART>assign letter=F
DISKPART>exit
system32>format N: /fs:ntfs /q /y
system32>format F: /fs:ntfs /q /v:Recovery /y
system32>exit
    
```



```

X:\I386\SYSTEM32\CMD.EXE
X:\I386\SYSTEM32>diskpart → Starts the Microsoft disk partitioning tool.

Microsoft DiskPart version 5.2.3790.1830
Copyright (C) 1999-2001 Microsoft Corporation.
On computer: MININT-JUC

DISKPART>list vol → Show partition information

Volume ### Ltr Label Fs Type Size Status Info
-----
Volume 0 X CD_ROM CDFS DUD-ROM 405 MB Healthy Boot
Volume 1 D FAT32 Removeable 3854 MB Healthy

DISKPART>sel disk 0 → Select a disk
Disk 0 is now the selected disk.

DISKPART>create part pri size=2000 → Create partition 1 and assign a size.
This partition is for OS installation.
DiskPart succeeded in creating the specified partition.

DISKPART>assign letter=N → Assign partition 1 a code name (N).
DiskPart successfully assigned the drive letter or mount point.

DISKPART>create part pri size=1800 → Create partition 2 and assign a size.
This partition is for recovery images.
DiskPart succeeded in creating the specified partition.

DISKPART>assign letter=F → Assign partition 2 a code name (F).
DiskPart successfully assigned the drive letter or mount point.

DISKPART>exit → Exit diskpart

X:\I386\SYSTEM32>format n: /fs:ntfs /q /y → Format partition 1 (N) as NTFS format.
The type of the file system is RAW.
The new file system is NTFS.
QuickFormatting 2000M
Creating file system structures.
Format complete.
2048254 KB total disk space.
2035620 KB are available.

X:\I386\SYSTEM32>format f: /fs:ntfs /q /v:Recovery /y → Formate partition 2 (F) as NTFS formate and
name it as "Recovery".
The type of the file system is RAW.
The new file system is NTFS.
QuickFormatting 1804M
Creating file system structures.
Format complete.
1847474 KB total disk space.
1835860 KB are available.

X:\I386\SYSTEM32>exit → Exit Windows PE
  
```

Figure C-5: Partition Creation Commands

**NOTE:**

Use the following commands to check if the partitions were created successfully.

```
X:\I386\SYSTEM32>diskpart
Microsoft DiskPart version 5.2.3790.1830
Copyright (C) 1999-2001 Microsoft Corporation.
On computer: MININT-JUC

DISKPART> sel disk 0
Disk 0 is now the selected disk.

DISKPART> list part

   Partition ###   Type              Size              Offset
-----
   Partition 1     Primary           2000 MB           32 KB
   Partition 2     Primary           1804 MB          2000 MB

DISKPART> exit
```

Press any key to exit the recovery tool and automatically reboot the system. Please continue to the following procedure: Build-up Recovery Partition.

C.2.3 Install Operating System, Drivers and Applications

Install the operating system onto the unlabelled partition. The partition labeled as "Recovery" is for use by the system recovery tool and should not be used for installing the operating system or any applications.

**NOTE:**

The operating system installation program may offer to reformat the chosen partition. DO NOT format the partition again. The partition has already been formatted and is ready for installing the new operating system.

To install the operating system, insert the operating system installation CD into the optical drive. Restart the computer and follow the installation instructions.

KINO-PV-D5253-D4253 Mini-ITX Motherboard

C.2.4 Build-up Recovery Partition

Put the recover CD in the optical drive.

Start the system.

Boot the system from recovery CD. When prompted, press any key to boot from the recovery CD. It will take a while to launch the recovery tool. Please be patient!



Figure C-6: Launching the Recovery Tool

When the recovery tool setup menu appears, press <2> then <Enter>.

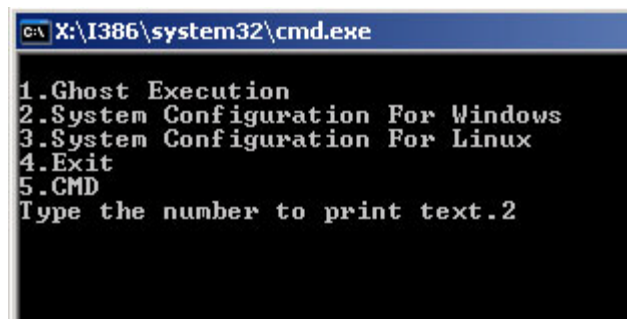

Figure C-7: System Configuration for Windows

The Symantec Ghost window appears and starts configuring the system to build-up a recovery partition. In this process, the partition which is created for recovery files in **Section C.2.2** is hidden and the recovery tool is saved in this partition.

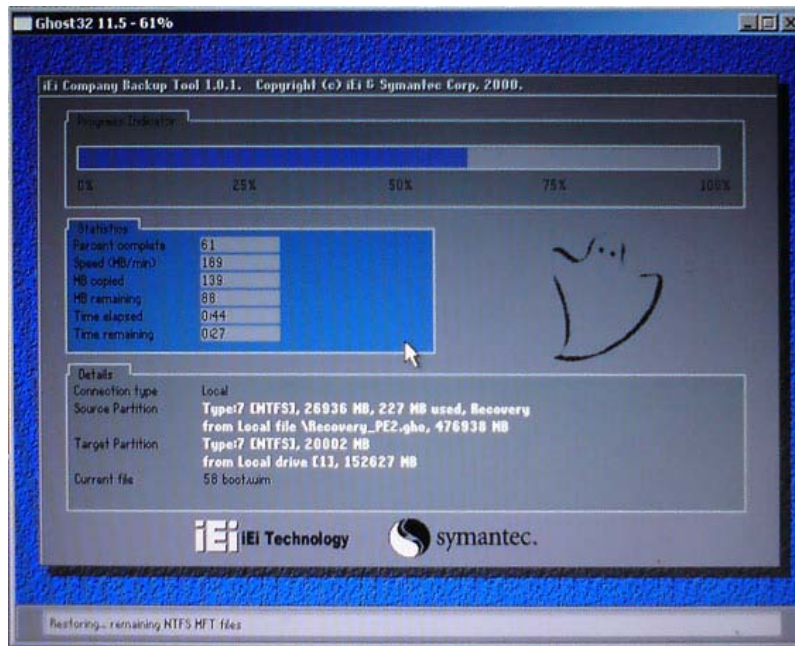

Figure C-8: Build-up Recovery Partition

After completing the system configuration, press any key in the following window to reboot the system.

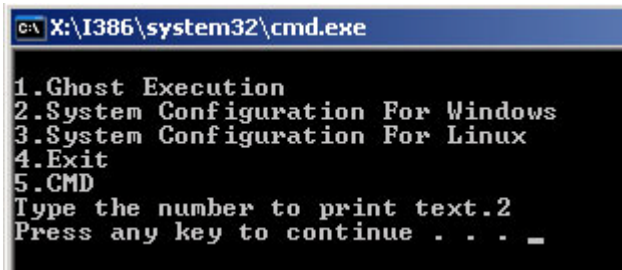

Figure C-9: Press any key to continue

Eject the recovery CD.

C.2.5 Create Factory Default Image



NOTE:

Before creating the factory default image, please configure the system to a factory default environment, including driver and application installations.

To create a factory default image, please follow the steps below.

Turn on the system. When the following screen displays (**Figure C-10**), press the <F3> key to access the recovery tool. The message will display for 10 seconds, please press F3 before the system boots into the operating system.

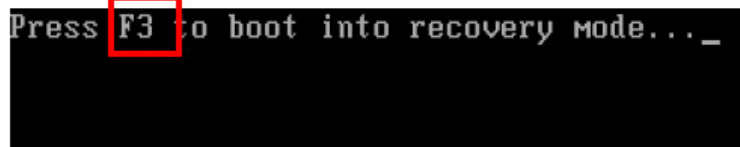

```
Press F3 to boot into recovery mode... _
```

Figure C-10: Press F3 to Boot into Recovery Mode

The recovery tool menu appears. Type <4> and press <Enter>. (**Figure C-11**)

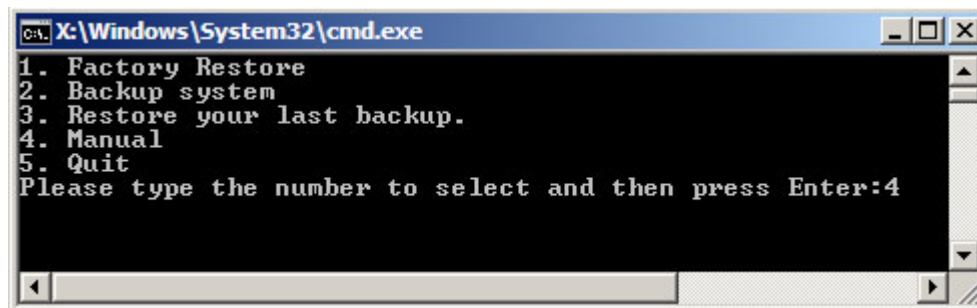

Figure C-11: Recovery Tool Menu

The About Symantec Ghost window appears. Click **OK** button to continue.

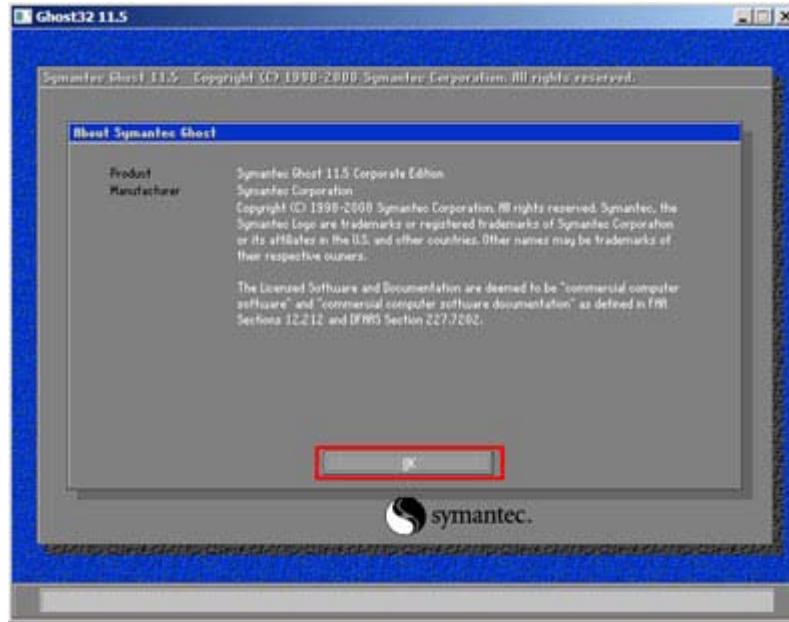

Figure C-12: About Symantec Ghost Window

Use mouse to navigate to the option shown below (Figure C-13).

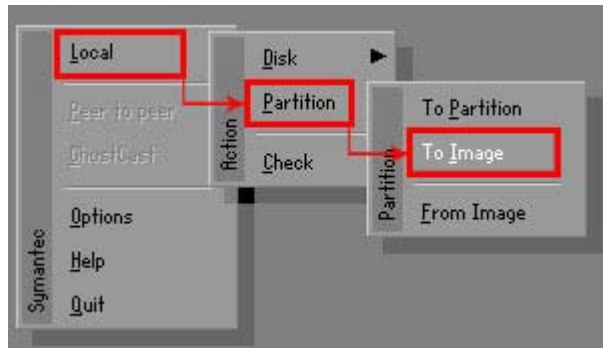

Figure C-13: Symantec Ghost Path

Select the local source drive (Drive 1) as shown in Figure C-14. Then click OK.

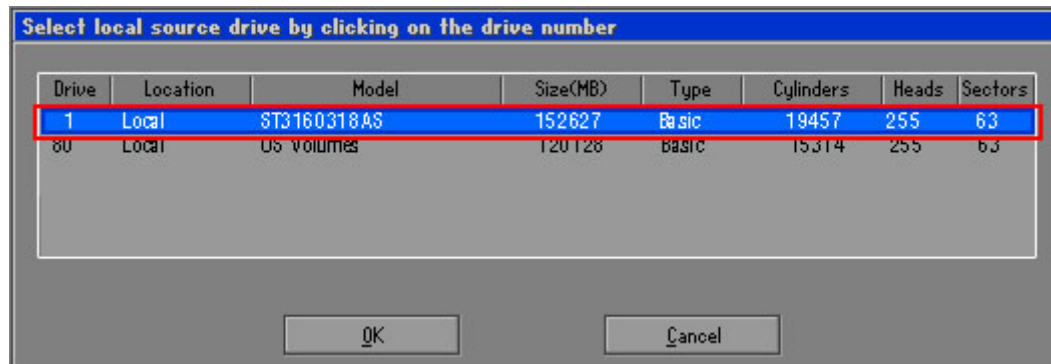

Figure C-14: Select a Local Source Drive

Select a source partition (Part 1) from basic drive as shown in **Figure C-15**. Then click OK.

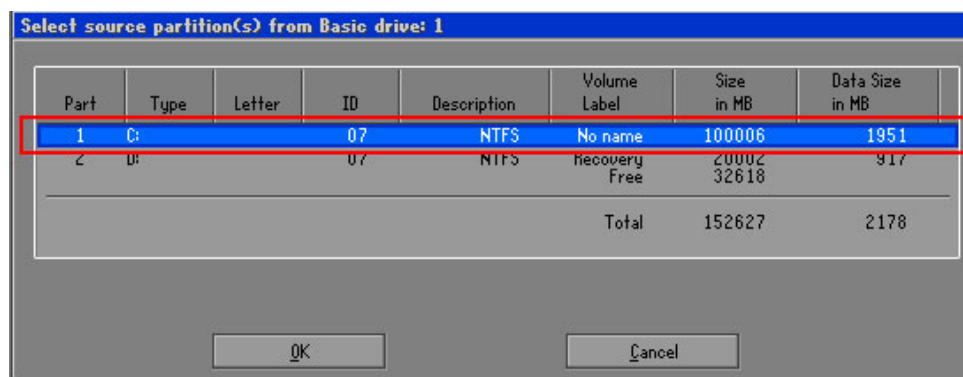

Figure C-15: Select a Source Partition from Basic Drive

Select 1.2: **[Recovery] NTFS drive** and enter a file name called **iei** (**Figure C-16**). Click **Save**. The factory default image will then be saved in the selected recovery drive and named IEI.GHO.



WARNING:

The file name of the factory default image must be **iei.GHO**.

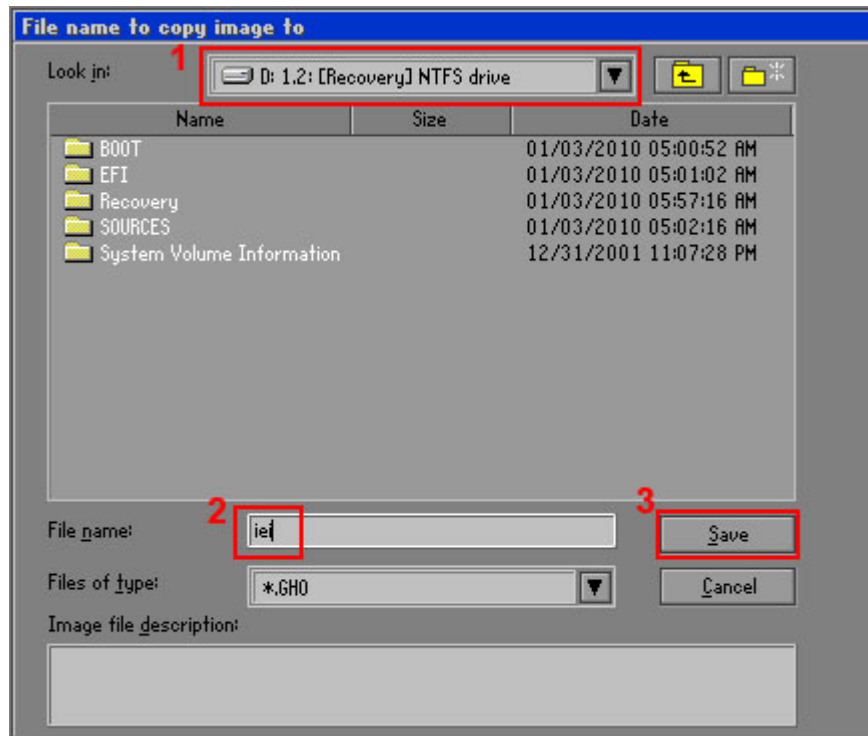

Figure C-16: File Name to Copy Image to

When the Compress Image screen in **Figure C-17** prompts, click **High** to make the image file smaller.

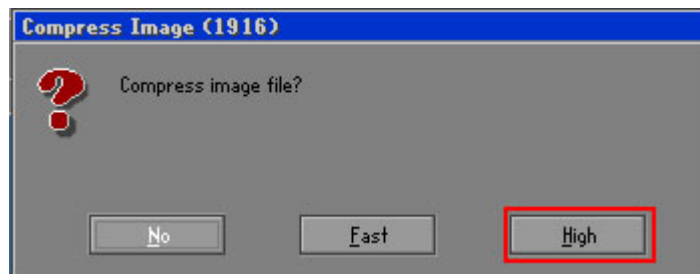

Figure C-17: Compress Image

KINO-PV-D5253-D4253 Mini-ITX Motherboard

The Proceed with partition image creation window appears, click **Yes** to continue.

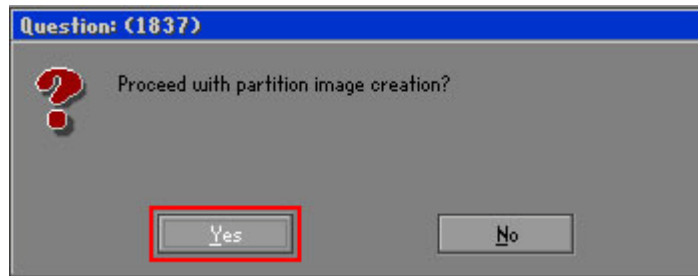

Figure C-18: Image Creation Confirmation

The Symantec Ghost starts to create the factory default image (**Figure C-19**).

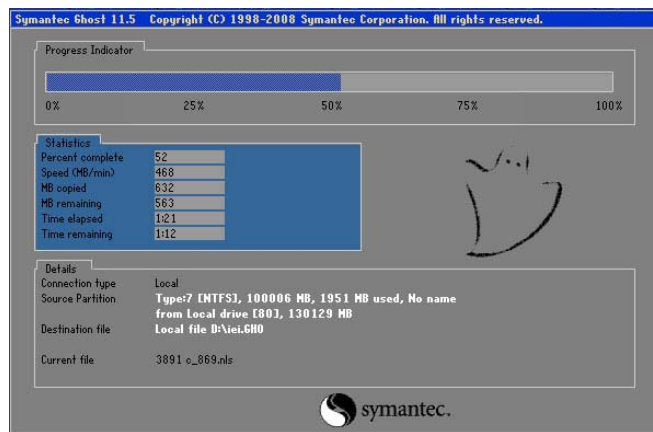

Figure C-19: Image Creation Process

When the image creation completes, a screen prompts as shown in **Figure C-20**. Click **Continue** and close the Ghost window to exit the program.

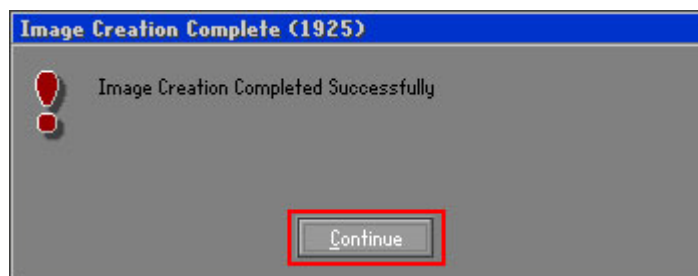
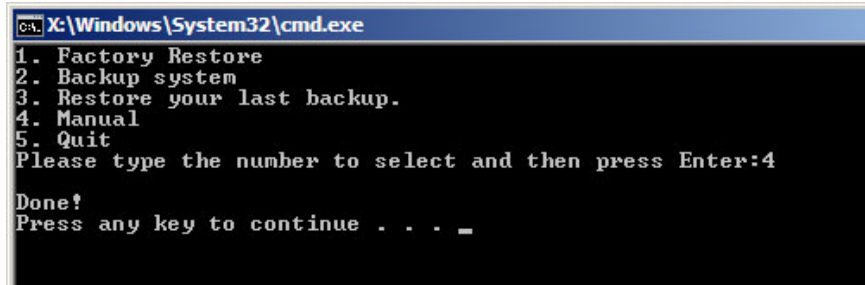

Figure C-20: Image Creation Complete

The recovery tool main menu window is shown as below. Press any key to reboot the system.



```

C:\Windows\System32\cmd.exe
1. Factory Restore
2. Backup system
3. Restore your last backup.
4. Manual
5. Quit
Please type the number to select and then press Enter:4
Done!
Press any key to continue . . . _
  
```

Figure C-21: Press Any Key to Continue

C.3 Setup Procedure for Linux

The initial setup procedures for Linux system are mostly the same with the procedure for Microsoft Windows. Please follow the steps below to setup recovery tool for Linux OS.

Hardware and BIOS setup. Refer to **Section C.2.1**.

Install Linux operating system. Make sure to install GRUB (v0.97 or earlier) MBR type and Ext3 partition type. Leave enough space on the hard drive to create the recover partition later.



NOTE:

If the Linux OS is not installed with GRUB (v0.97 or earlier) and Ext3, the Symantec Ghost may not function properly.

While installing Linux OS, please create two partitions:

- Partition 1: /
- Partition 2: **SWAP**

**NOTE:**

Please reserve enough space for partition 3 for saving recovery images.

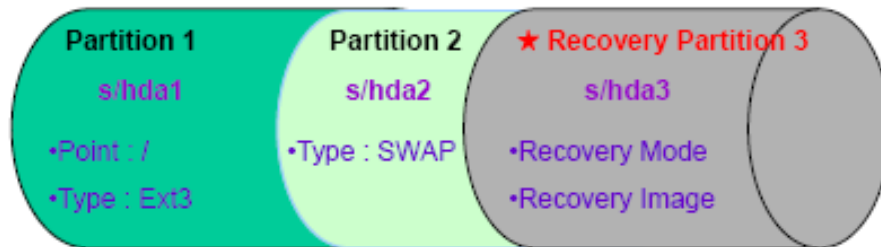

Figure C-22: Partitions for Linux

Create a recovery partition. Insert the recovery CD into the optical disk drive. Follow

Step 1 ~ Step 3 described in **Section C.2.2**. Then type the following commands (marked in red) to create a partition for recovery images.

```
system32>diskpart
DISKPART>list vol
DISKPART>sel disk 0
DISKPART>create part pri size= ____
DISKPART>assign letter=N
DISKPART>exit
system32>format N: /fs:ntfs /q /v:Recovery /y
system32>exit
```

Build-up recovery partition. Press any key to boot from the recovery CD. It will take a while to launch the recovery tool. Please be patient. When the recovery tool setup menu appears, type <3> and press <Enter> (**Figure C-23**). The Symantec Ghost window appears and starts configuring the system to build-up a recovery partition. After completing the system configuration, press any key to reboot the system. Eject the recovery CD.

```
C:\X:\I386\system32\cmd.exe
1.Ghost Execution
2.System Configuration For Windows
3.System Configuration For Linux
4.Exit
5.CMD
Type the number to print text.3
```

Figure C-23: System Configuration for Linux

Access the recovery tool main menu by modifying the “menu.lst”. To first access the recovery tool main menu, the menu.lst must be modified. In Linux system, enter Administrator (root). When prompt appears, type:

```
cd /boot/grub
```

```
vi menu.lst
```

```
Fedora release 9 (Sulphur)
Kernel 2.6.25-14.fc9.i686 on an i686 (tty2)

localhost login: root
Password:
[root@localhost ~]# cd /boot/grub/
[root@localhost grub]# vi menu.lst _
```

Figure C-24: Access menu.lst in Linux (Text Mode)

Modify the menu.lst as shown below.

```
#boot=/dev/sda
default=0
timeout=10
splashimage=(hd0,0)/grub/splash.xpm.gz
hiddenmenu
title Fedora (2.6.25-14.fc9.i686)
    root (hd0,0)
    kernel /vmlinuz-2.6.25-14.fc9.i686 ro root=UUID=10f1acd
ac38b5c78910 rhgb quiet
    initrd /initrd-2.6.25-14.fc9.i686.img

title Recovery Partition
root (hd0,2)
makeactive
chainloader +1
```

- **Type command:**
title Recovery Partition
root (hd0,2)
makeactive
chainloader +1

The recovery tool menu appears. (Figure C-25)

```
1. Factory Restore
2. Backup system
3. Restore your last backup.
4. Manual
5. Quit
Please type the number to select and then press Enter:
```

Figure C-25: Recovery Tool Menu

Create a factory default image. Follow **Step 2 ~ Step 12** described in **Section C.2.5** to create a factory default image.

C.4 Recovery Tool Functions

After completing the initial setup procedures as described above, users can access the recovery tool by pressing **<F3>** while booting up the system. The main menu of the recovery tool is shown below.

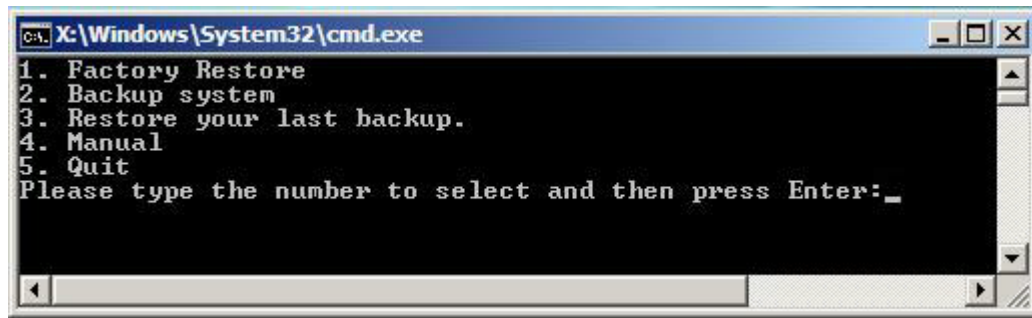

Figure C-26: Recovery Tool Main Menu

The recovery tool has several functions including:

6. **Factory Restore:** Restore the factory default image (iei.GHO) created in **Section C.2.5**.
7. **Backup system:** Create a system backup image (iei_user.GHO) which will be saved in the hidden partition.
8. **Restore your last backup:** Restore the last system backup image
9. **Manual:** Enter the Symantec Ghost window to configure manually.
10. **Quit:** Exit the recovery tool and restart the system.



WARNING:

Please do not turn off the system power during the process of system recovery or backup.



WARNING:

All data in the system will be deleted during the system recovery. Please backup the system files before restoring the system (either Factory Restore or Restore Backup).

C.4.1 Factory Restore

To restore the factory default image, please follow the steps below.

Step 1: Type <1> and press <Enter> in the main menu.

The Symantec Ghost window appears and starts to restore the factory default. A factory default image called **iei.GHO** is created in the hidden Recovery partition.

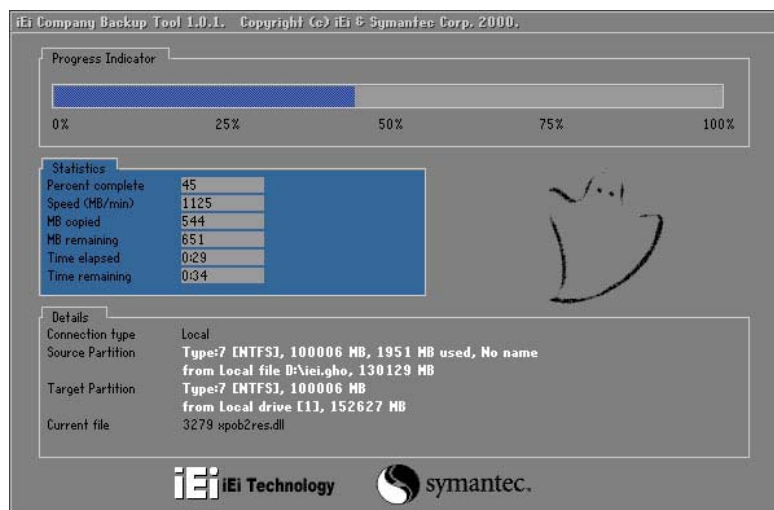

Figure C-27: Restore Factory Default

The screen is shown as in **Figure C-28** when completed. Press any key to reboot the system.

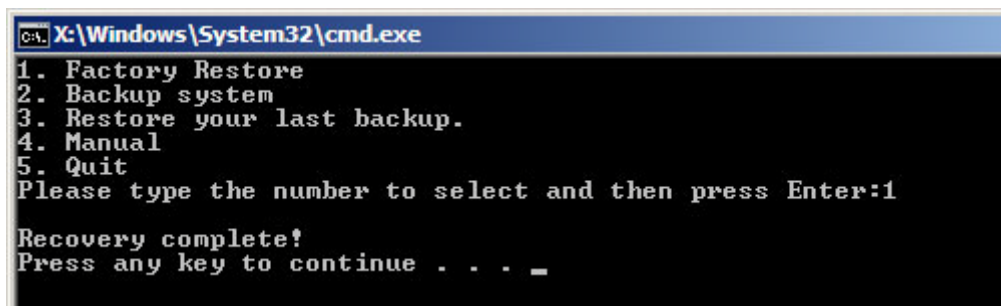

Figure C-28: Recovery Complete Window

C.4.2 Backup System

To backup the system, please follow the steps below.

Step 2: Type <2> and press <Enter> in the main menu.

The Symantec Ghost window appears and starts to backup the system. A backup image called **iei_user.GHO** is created in the hidden Recovery partition.

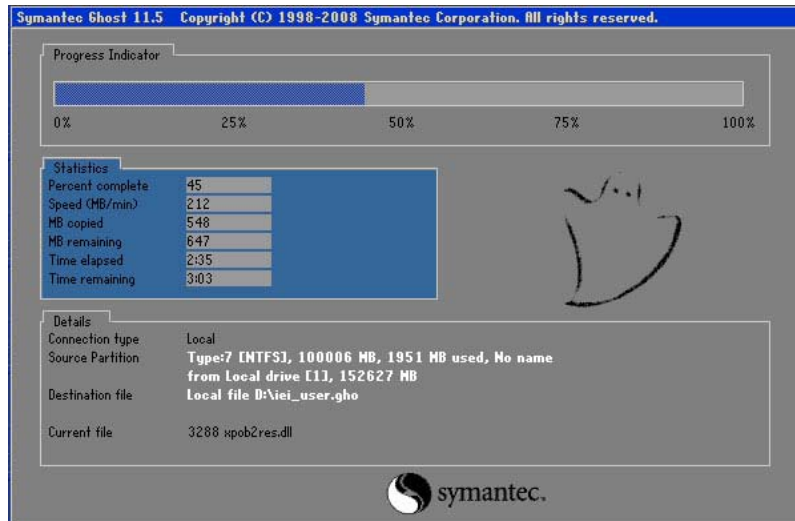

Figure C-29: Backup System

The screen is shown as in **Figure C-30** when system backup is completed. Press any key to reboot the system.

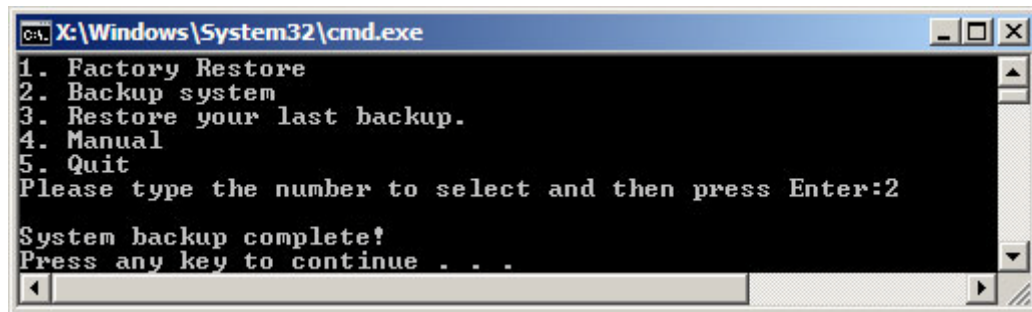

Figure C-30: System Backup Complete Window

C.4.3 Restore Your Last Backup

To restore the last system backup, please follow the steps below.

Step 3: Type <3> and press <Enter> in the main menu.

The Symantec Ghost window appears and starts to restore the last backup image (iei_user.GHO).

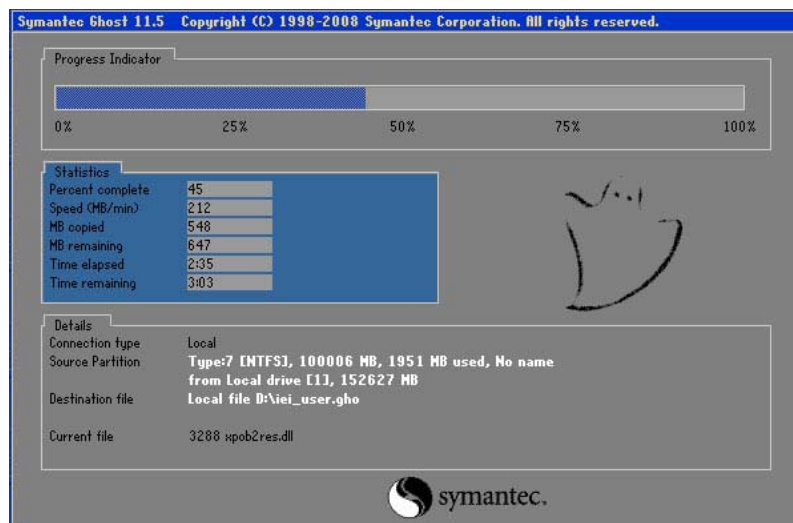

Figure C-31: Restore Backup

The screen is shown as in **Figure C-32** when backup recovery is completed. Press any key to reboot the system.

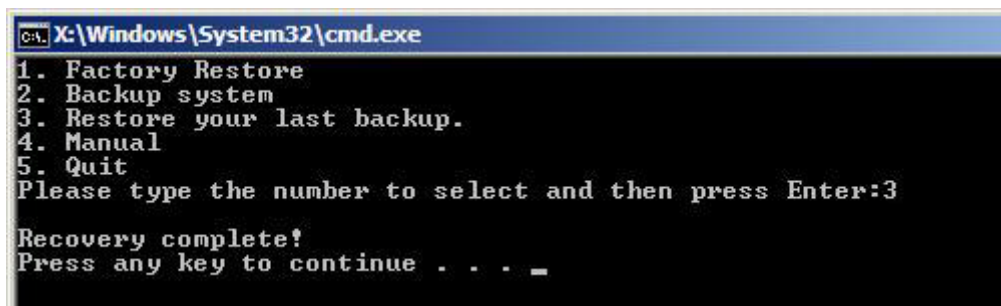

Figure C-32: Restore System Backup Complete Window

C.4.4 Manual

To restore the last system backup, please follow the steps below.

Step 4: Type <4> and press <Enter> in the main menu.

The Symantec Ghost window appears. Use the Ghost program to backup or recover the system manually.

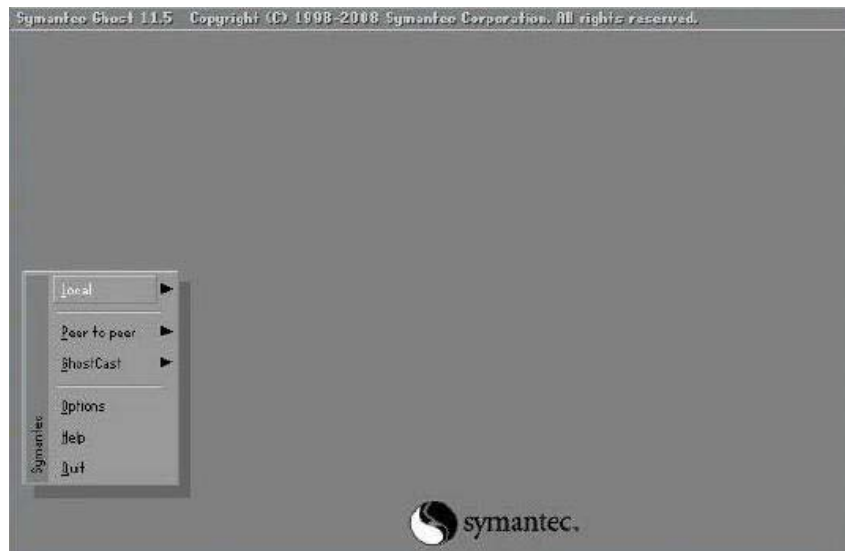

Figure C-33: Symantec Ghost Window

When backup or recovery is completed, press any key to reboot the system.

C.5 Other Information

C.5.1 Using AHCI Mode or ALi M5283 / VIA VT6421A Controller

When the system uses AHCI mode or some specific SATA controllers such as ALi M5283 or VIA VT6421A, the SATA RAID/AHCI driver must be installed before using one key recovery. Please follow the steps below to install the SATA RAID/AHCI driver.

Copy the SATA RAID/AHCI driver to a floppy disk and insert the floppy disk into a USB floppy disk drive. The SATA RAID/AHCI driver must be especially designed for the on-board SATA controller.

Connect the USB floppy disk drive to the system.

Insert the One Key Recovery CD into the system and boot the system from the CD.

When launching the recovery tool, press <F6>.

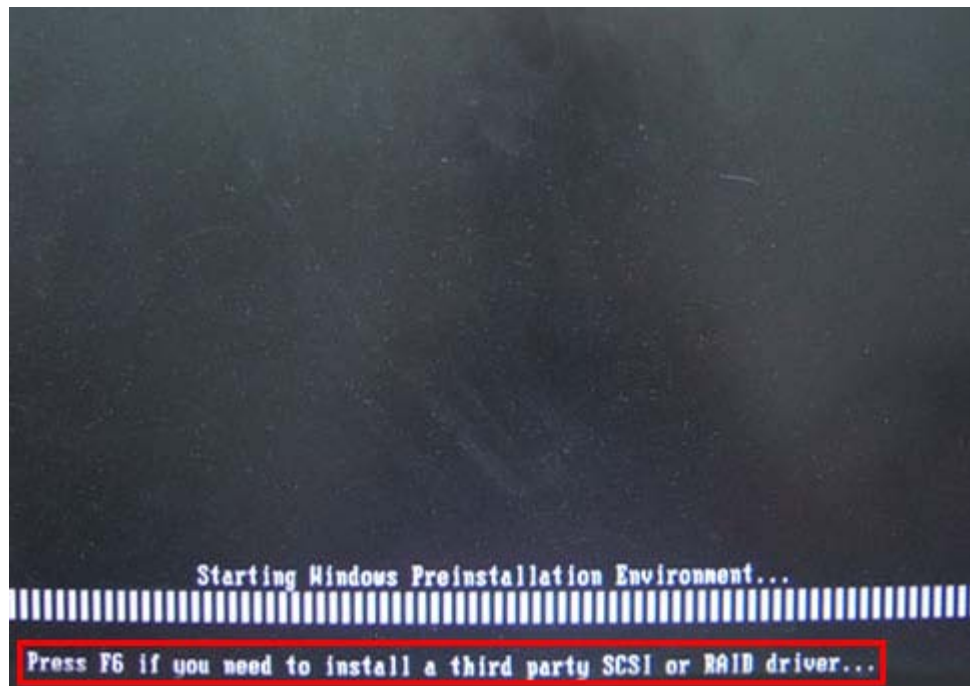

When the following window appears, press <S> to select "Specify Additional Device".

```
Setup could not determine the type of one or more mass storage devices
installed in your system, or you have chosen to manually specify an adapter.
Currently, Setup will load support for the following mass storage device(s):
```

```
<none>
```

- To specify additional SCSI adapters, CD-ROM drives, or special disk controllers for use with Windows, including those for which you have a device support disk from a mass storage device manufacturer, press S.
- If you do not have any device support disks from a mass storage device manufacturer, or do not want to specify additional mass storage devices for use with Windows, press ENTER.

```
S=Specify Additional Device  ENTER=Continue  F3=Exit
```

In the following window, select a SATA controller mode used in the system. Then press <Enter>. The user can now start using the SATA HDD.

```
You have chosen to configure a SCSI Adapter for use with Windows,
using a device support disk provided by an adapter manufacturer.
```

```
Select the SCSI Adapter you want from the following list, or press ESC
to return to the previous screen.
```

```
VIA U-RAID Controller Series(Windows XP/SRV2003)
VIA U-RAID Controller Series(Windows XP/SRV2003-x64)
VIA U-RAID Controller Series(Windows 2K)
VIA U-RAID Controller Series(Windows NT4)
```

```
ENTER>Select  F3=Exit
```

After pressing <Enter>, the system will get into the recovery tool setup menu. Continue to follow the setup procedure from **Step 4** in **Section C.2.2 Create Partitions** to finish the whole setup process.

C.5.2 System Memory Requirement

To be able to access the recovery tool by pressing <F3> while booting up the system, please make sure to have enough system memory. The minimum memory requirement is listed below.

- **Using Award BIOS:** 128 MB system memory
- **Using AMI BIOS:** 512 MB system memory.

Appendix

D

Watchdog Timer



NOTE:

The following discussion applies to DOS. Contact IEI support or visit the IEI website for drivers for other operating systems.

The Watchdog Timer is a hardware-based timer that attempts to restart the system when it stops working. The system may stop working because of external EMI or software bugs. The Watchdog Timer ensures that standalone systems like ATMs will automatically attempt to restart in the case of system problems.

A BIOS function call (INT 15H) is used to control the Watchdog Timer.

INT 15H:

AH – 6FH Sub-function:	
AL – 2:	Sets the Watchdog Timer's period.
BL:	Time-out value (Its unit-second is dependent on the item "Watchdog Timer unit select" in CMOS setup).

Table D-1: AH-6FH Sub-function

Call sub-function 2 to set the time-out period of Watchdog Timer first. If the time-out value is not zero, the Watchdog Timer starts counting down. When the timer value reaches zero, the system resets. To ensure that this reset condition does not occur, calling sub-function 2 must periodically refresh the Watchdog Timer. However, the watchdog timer is disabled if the time-out value is set to zero.

A tolerance of at least 10% must be maintained to avoid unknown routines within the operating system (DOS), such as disk I/O that can be very time-consuming.

**NOTE:**

The Watchdog Timer is activated through software. The software application that activates the Watchdog Timer must also deactivate it when closed. If the Watchdog Timer is not deactivated, the system will automatically restart after the Timer has finished its countdown.

EXAMPLE PROGRAM:**; INITIAL TIMER PERIOD COUNTER**

;

W_LOOP:

;

```
MOV    AX, 6F02H    ;setting the time-out value
MOV    BL, 30       ;time-out value is 48 seconds
INT    15H
```

;

; ADD THE APPLICATION PROGRAM HERE

;

```
CMP    EXIT_AP, 1   ;is the application over?
JNE    W_LOOP       ;No, restart the application
MOV    AX, 6F02H    ;disable Watchdog Timer
MOV    BL, 0        ;
INT    15H
```

;

; EXIT ;

Appendix

E

Digital I/O Interface

E.1 Introduction

The digital I/O is used for machine control and automation.

E.2 DIO Connector Pinouts

Located in the Connectors section of this document.

E.3 Assembly Language Example

```

;*****
; DIO Port:   Int15                (Fintek 81865)
              Input   ax=6F08h
                      bl: bit 0 ~ 3
              output  ax=6F09h
                      bl: bit 0 ~ 3
;*****

Din :
    mov     dx, 2Eh                ;Select Index Register
    mov     al, 87h
    out     dx, al                 ;Write twice
    mov     al, 87h
    out     dx, al

    mov     ax, 0607h              ;Logic Device 6
    mov     dx, 2Eh                ;Select Index Register
    out     dx, al
    inc     dx                      ;DX = data port address
    xchg    al, ah
    out     dx, al

    mov     al, 0F2h              ;GPIO pin status register
    mov     dx, 2Eh                ;Select Index Register
    out     dx, al
    inc     dx                      ;DX = data port address
    in      al, dx
    and     al, 00Fh
    mov     bl, al

    mov     dx, 2Eh                ;Select Index Register
    mov     al, 0AAh
    out     dx, al                 ;Eixt configuration mode

Dout :
    mov     dx, 2Eh                ;Select Index Register
    mov     al, 87h
    out     dx, al                 ;Write twice
    mov     al, 087h
    out     dx, al

```

KINO-PV-D5253-D4253 Mini-ITX Motherboard

```

mov     ax, 0607h           ;Logic Device 6
mov     dx, 2Eh            ;Select Index Register
out     dx, al
inc     dx                 ;DX = data port address
xchg   al, ah
out     dx, al

mov     cl,bl
and     bl, 1
shl    bl, 4
mov     al, 0F1h          ;GPIO0 output register
mov     ah, bl

mov     dx, 2Eh            ;Select Index Register
out     dx, al
inc     dx                 ;DX = data port address
xchg   al, ah
out     dx, al

and     cl, NOT 1
shr    cl, 1
mov     ah, cl
mov     al, 0A1h          ;GPIO5 output register

mov     dx, 2Eh            ;Select Index Register
out     dx, al
inc     dx                 ;DX = data port address
xchg   al, ah
out     dx, al

mov     dx, 2Eh            ;Select Index Register
mov     al, 0AAh
out     dx, al            ;Eixt configuration mode

```



Appendix

F

Hazardous Materials Disclosure

F.1 Hazardous Materials Disclosure Table for IPB Products Certified as RoHS Compliant Under 2002/95/EC Without Mercury

The details provided in this appendix are to ensure that the product is compliant with the Peoples Republic of China (China) RoHS standards. The table below acknowledges the presences of small quantities of certain materials in the product, and is applicable to China RoHS only.

A label will be placed on each product to indicate the estimated “Environmentally Friendly Use Period” (EFUP). This is an estimate of the number of years that these substances would “not leak out or undergo abrupt change.” This product may contain replaceable sub-assemblies/components which have a shorter EFUP such as batteries and lamps. These components will be separately marked.

Please refer to the table on the next page.

Part Name	Toxic or Hazardous Substances and Elements					
	Lead (Pb)	Mercury (Hg)	Cadmium (Cd)	Hexavalent Chromium (CR(VI))	Polybrominated Biphenyls (PBB)	Polybrominated Diphenyl Ethers (PBDE)
Housing	X	O	O	O	O	X
Display	X	O	O	O	O	X
Printed Circuit Board	X	O	O	O	O	X
Metal Fasteners	X	O	O	O	O	O
Cable Assembly	X	O	O	O	O	X
Fan Assembly	X	O	O	O	O	X
Power Supply Assemblies	X	O	O	O	O	X
Battery	O	O	O	O	O	O

O: This toxic or hazardous substance is contained in all of the homogeneous materials for the part is below the limit requirement in SJ/T11363-2006

X: This toxic or hazardous substance is contained in at least one of the homogeneous materials for this part is above the limit requirement in SJ/T11363-2006

KINO-PV-D5253-D4253 Mini-ITX Motherboard

此附件旨在确保本产品符合中国 RoHS 标准。以下表格标示此产品中某有毒物质的含量符合中国 RoHS 标准规定的限量要求。

本产品上会附有“环境友好使用期限”的标签，此期限是估算这些物质“不会有泄漏或突变”的年限。本产品可能包含有较短的环境友好使用期限的可替换元件，像是电池或灯管，这些元件将会单独标示出来。

部件名称	有毒有害物质或元素					
	铅 (Pb)	汞 (Hg)	镉 (Cd)	六价铬 (CR(VI))	多溴联苯 (PBB)	多溴二苯 醚 (PBDE)
壳体	X	O	O	O	O	X
显示	X	O	O	O	O	X
印刷电路板	X	O	O	O	O	X
金属螺帽	X	O	O	O	O	O
电缆组装	X	O	O	O	O	X
风扇组装	X	O	O	O	O	X
电力供应组装	X	O	O	O	O	X
电池	O	O	O	O	O	O

O: 表示该有毒有害物质在该部件所有物质材料中的含量均在 SJ/T11363-2006 标准规定的限量要求以下。
X: 表示该有毒有害物质至少在该部件的某一均质材料中的含量超出 SJ/T11363-2006 标准规定的限量要求。

F.2