

# IEI Riser Card

## PCI Riser Card



**PCIR-K01R-R10**

1-slot PCI riser card  
89.1 x 62.8 x 16 mm  
PCI 2.2 standard with 32-bit 5V support

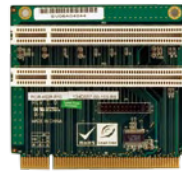
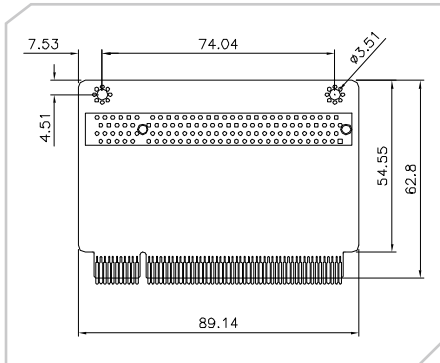

**PCIR-K02R-R10**

2-slot PCI riser card  
89.1 x 83.1 x 16 mm  
PCI 2.2 standard with 32-bit 5V support

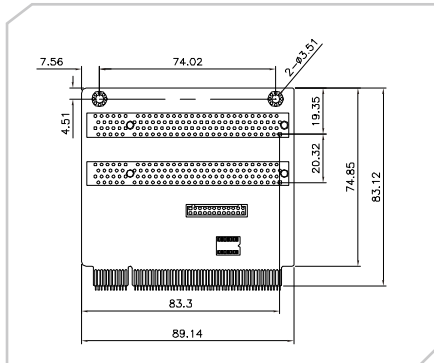

**PCIR-K03R-R10**

3-slot PCI riser card  
89.1 x 103.4 x 16 mm  
PCI 2.2 standard with 32-bit 5V support

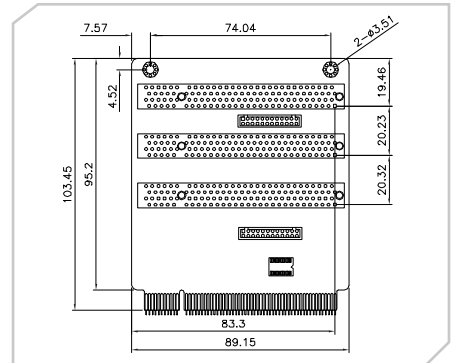

## PCI Riser Card by Cable



**PCIR-CB01R-R10**

1-slot PCI riser card 18.5 x 111.9 mm

**Packing list:**

- 2 x PCI riser card connection cable
- 1 x 1-Slot PCI riser card
- 1 x Golden finger connection board
- 1 x QIG

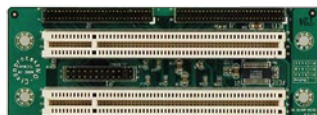
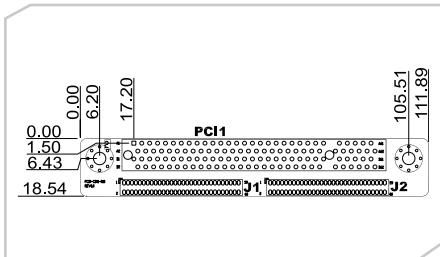

**PCIR-CB02R-R10**

2-slot PCI riser card 38.9 x 111.9 mm

**Packing list:**

- 2 x PCI riser card connection cable
- 1 x 2-Slot PCI riser card
- 1 x Golden finger connection board
- 1 x QIG

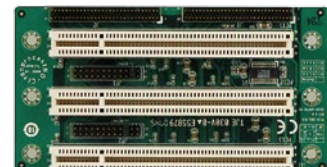
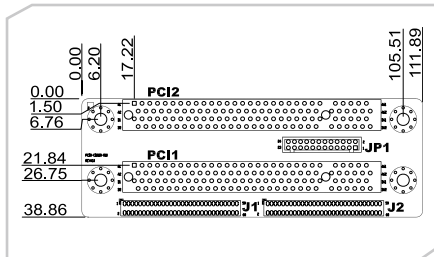

**PCIR-CB03R-R10**

3-slot PCI riser card 59.2 x 111.9 mm

**Packing list:**

- 2 x PCI riser card connection cable
- 1 x 3-Slot PCI riser card
- 1 x Golden finger connection board
- 1 x QIG

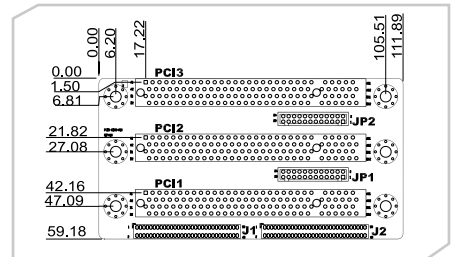

### Compliant motherboard

PCIR-CB01R PCIR-K01R	PCIR-CB02R PCIR-K02R	PCIR-CB03R PCIR-K03R
<ul style="list-style-type: none"> <li>IMBA/IMB series (Micro ATX/ ATX)</li> <li>KINO series (Mini-ITX)</li> <li>NOVA series (5.25" SBC)</li> </ul>	<ul style="list-style-type: none"> <li>KINO-9652-R11</li> <li>KINO-9453-R21</li> </ul>	<ul style="list-style-type: none"> <li>KINO-9652-R11</li> <li>KINO-9453-R21</li> </ul>

### Golden finger connection board (PCIR-CB04GF-R10)

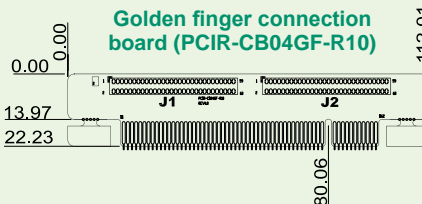

## PCIER Riser Card

### PCIe x 1 Riser Card

**PCIER-K101L-R10**

Dimensions: 135x 31mm

**Packing List**

1 x PCIe x1 riser card	1 x QIG
------------------------	---------



**Compatible model list** KINO-PVN-D4251/D5251, KINO-PV-D4252/D5252

- Industrial Computing Solutions
- Video Capture Solutions
- Embedded Computing Solutions
- Industrial Data Collector and Controller
- Panel Solutions Introduction
- ORing Network Communication
- Power Supply/Peripherals