



IEI Technology Corp.



MODEL:
RPC-6010G

8.4" TFT LCD 4U 14-slot Rackmount LCD Workstation

User Manual

Rev. 1.0 December 2006



Revision

MODEL	RPC6010G Rackmount Workstation	
Revision Number	Description	Date of Issue
1.0	Initial release	December 2006

Copyright

COPYRIGHT NOTICE

The information in this document is subject to change without prior notice in order to improve reliability, design and function and does not represent a commitment on the part of the manufacturer.

In no event will the manufacturer be liable for direct, indirect, special, incidental, or consequential damages arising out of the use or inability to use the product or documentation, even if advised of the possibility of such damages.

This document contains proprietary information protected by copyright. All rights are reserved. No part of this manual may be reproduced by any mechanical, electronic, or other means in any form without prior written permission of the manufacturer.

TRADEMARKS

IBM PC is a registered trademark of International Business Machines Corporation. INTEL is a registered trademark of INTEL Corporation. Other product names mentioned herein are used for identification purposes only and may be trademarks and/or registered trademarks of their respective owners.

Packing List

**NOTE:**

If any of the components listed in the checklist below are missing, please do not proceed with the installation. Contact the IEI reseller or vendor you purchased the RPC-6010G rackmount workstation from or contact an IEI sales representative directly. To contact an IEI sales representative, please send an email to sales@iei.com.tw.

The items listed below should all be included in the RPC-6010G Rackmount Workstation package.

- 1 x RPC-6010G Rackmount LCD Workstation
- 1 x Backplane to SBC connector cable
- 2 x Door keys
- 2 x Handles
- 2 x Handle brackets
- 1 x Mini-DIN 6 PS/2 connector cable
- 1 x Power cable (EU)
- 1 x Screw kit
- 7 x Short card clamps
- 2 x 4-pin USB cable
- 1 x VGA cable

For Touch Panel (T-R) Models only:

- 1 x RS-232 cable
- 1 x TouchKit Driver CD
- 1 x Touch Pen

Images of the above items are shown in **Section 4.2.3**.

Table of Contents

1	INTRODUCTION.....	1
1.1	RPC-6010G OVERVIEW.....	2
1.2	RPC-6010G FEATURES.....	2
1.3	MODEL VARIATIONS.....	2
1.4	CERTIFICATIONS.....	3
2	MECHANICAL OVERVIEW.....	5
2.1	EXTERNAL OVERVIEW.....	6
2.1.1	<i>Front Panel</i>	6
2.1.2	<i>Rear Panel</i>	7
2.1.2.1	14-Slot Rear Panel.....	7
2.1.2.2	ATX Motherboard Rear Panel.....	8
2.1.3	<i>Right Side Panel</i>	9
2.1.4	<i>Left Side Panel</i>	10
2.2	PHYSICAL DIMENSIONS.....	10
2.2.1	<i>General Physical Dimensions</i>	10
2.2.2	<i>RPC-6010G Physical Dimensions</i>	11
3	DETAILED SPECIFICATIONS.....	13
3.1	RPC-6010G SPECIFICATIONS.....	14
3.2	LCD SPECIFICATIONS.....	15
3.3	ACE-832AP PSU SPECIFICATIONS.....	16
3.4	RECOMMENDED IEI BACKPLANES, MOTHERBOARDS AND PSUs.....	16
4	INSTALLATION.....	17
4.1	INSTALLATION CONSIDERATIONS.....	18
4.1.1	<i>Installation Precautions</i>	18
4.1.2	<i>Installation Prerequisites</i>	18
4.2	UNPACKING.....	19
4.2.1	<i>Packaging</i>	19
4.2.2	<i>Unpacking Procedure</i>	19

4.2.3 Packing List	20
4.3 PRE-INSTALLATION PREPARATION	22
4.3.1 System Planning.....	22
4.3.2 Tools	22
4.4 INSTALLATION PROCEDURES	23
4.4.1 Preinstalled Components	23
4.4.2 User Installed Components.....	23
4.4.3 Installation Steps.....	23
4.5 INSTALLING COMPONENTS INTO THE RPC-6010G	24
4.5.1 Remove the Top Cover	25
4.5.2 Remove the CPU Card Clamp	26
4.5.3 Remove the Dual CPU Card Clamp & Drive Bay Stabilizer Bracket	26
4.5.4 Remove the Drive Bracket	28
4.5.5 Remove the Drive Slot Blank Plate.....	28
4.5.6 Install Drives.....	29
4.5.6.1 5.25” Disk Drive	29
4.5.6.2 3.5” Disk Drive in a 5.25” Slot.....	30
4.5.6.3 3.5” Disk Drive	31
4.5.7 Reinstall the Drive Bracket.....	32
4.5.8 Install the Backplane.....	33
4.5.9 Install the CPU Card	35
4.5.10 Install the PCI/ISA Expansion Card	37
4.5.11 Installing Short Cards	38
4.5.12 Connect the Cables	39
4.5.13 Close the Top Cover.....	40
4.6 MOUNTING THE RPC-6010G RACKMOUNT WORKSTATION	40
5 MAINTENANCE.....	47
5.1 MAINTENANCE OVERVIEW.....	48
5.2 CPU CARD REPLACEMENT	48
5.3 PCI/ISA EXPANSION CARD REPLACEMENT	49
5.4 BACKPLANE REPLACEMENT.....	50
5.5 PSU REPLACEMENT.....	51
5.6 COOLING FAN REPLACEMENT	54
5.7 DISK DRIVE REPLACEMENT	57

RPC-6010G Rackmount LCD Workstation

5.7.1	3.5" Disk Drive Replacement	57
5.7.2	5.25" Disk Drive Replacement	58
6	ON SCREEN DISPLAY (OSD) CONTROLS	59
6.1	USER MODE OSD STRUCTURE	60
6.1.1	OSD Buttons.....	60
6.1.2	OSD Menu Structure	61
6.2	USING THE OSD.....	62
6.2.1	Main Display Features.....	62
6.2.2	Color	64
6.2.3	Language.....	65
6.2.4	OSD Configurations.....	66
6.2.5	Signal	67
6.2.6	Backlight	68
7	SOFTWARE DRIVER	69
7.1	TOUCH SCREEN DRIVER.....	70
7.2	DRIVER INSTALLATION.....	71
7.3	TOUCH SCREEN DRIVER CONFIGURATION.....	79
A	CERTIFICATIONS	81
A.1	ROHS COMPLIANT.....	82
B	RECOMMENDED IEI BACKPLANES, MOTHERBOARDS AND PSUS	83
B.1	RECOMMENDED IEI BACKPLANES AND MOTHERBOARDS	84
B.2	RECOMMENDED IEI POWER SUPPLY UNITS.....	85
	INDEX.....	87

List of Figures

Figure 2-1: RPC-6010G Front Panel	6
Figure 2-2: RPC-6010G Front Panel Door Open.....	7
Figure 2-3: RPC-6010G 14 Slot Rear Panel.....	8
Figure 2-4: RPC-6010G ATX Motherboard Rear Panel	9
Figure 2-5: RPC-6010G Right Side Panel.....	9
Figure 2-6: RPC-6010G Left Side Panel	10
Figure 2-7: RPC-6010G Physical Dimensions	11
Figure 4-1: Top Cover Left Side Retention Screws	25
Figure 4-2: Remove Top Cover from Chassis	25
Figure 4-3: CPU Card Clamp Right Side Retention Screws	26
Figure 4-4: Dual CPU Card Clamp Retention Screws.....	27
Figure 4-5: Dual CPU Card Clamp Fan Bracket Retention Screws	27
Figure 4-6: Drive Bracket Retention Screws	28
Figure 4-7: Drive Slot Blank Plate Retention Screws	29
Figure 4-8: 5.25" Disk Drive Retention Screws	30
Figure 4-9: 3.5" to 5.25" Drive Bay Rack Retention Screws	31
Figure 4-10: 3.5" Disk Drive Retention Screws	32
Figure 4-11: Install Copper Pillars and Plastic Spacers.....	33
Figure 4-12: Backplane Retention Screws	34
Figure 4-13: Slot Cover Retention Screw.....	36
Figure 4-14: Install the CPU Card	37
Figure 4-15: Installing a Short Card	39
Figure 4-16: Rack Handle Bracket Assembly and Installation	41
Figure 4-17: Remove Rack Slide.....	42
Figure 4-18: Workstation Slide Installation	43
Figure 4-19: Rack Slide Bracket Assembly	44
Figure 4-20: Rack Slide Bracket Installation	45

RPC-6010G Rackmount LCD Workstation

Figure 4-21: Install Workstation into Rack	46
Figure 5-1: PSU External Retention Screws.....	52
Figure 5-2: PSU Internal Retention Screws	52
Figure 5-3: PSU Mounting Bracket Retention Screws.....	53
Figure 5-4: Cooling Fan Bracket External Screws.....	55
Figure 5-5: Cooling Fan Bracket Bottom Panel Screws.....	55
Figure 5-6: Fan Retention Screws	56
Figure 6-1: OSD Control Buttons.....	60
Figure 6-2: Main Display Features.....	62
Figure 6-3: Color Options	64
Figure 6-4: Language Menu	65
Figure 6-5: OSD Configurations Menu	66
Figure 6-6: Signal Menu.....	67
Figure 6-7: Backlight Menu	68
Figure 7-1: Driver CD Pop Up Screen.....	71
Figure 7-2: Install Shield Wizard Preparation.....	72
Figure 7-3: Welcome Screen	72
Figure 7-4: Install PS/2 Interface Driver	73
Figure 7-5: Install PS/2 Interface Driver	74
Figure 7-6: Touch Monitor/USB Touch Controller Confirmation	74
Figure 7-7: Controller Installation Directory.....	75
Figure 7-8: Controller Installation Directory.....	76
Figure 7-9: Program Icon Directory.....	77
Figure 7-10: Installing	78
Figure 7-11: Installation Complete	79

List of Tables

Table 1-1: RPC-6010G Model Variations	3
Table 2-1: General Physical Dimensions	10
Table 3-1: RPC-6010G Specifications	14
Table 3-2: LCD Specifications.....	15
Table 3-3: ACE-832AP PSU Specifications.....	16
Table 4-1: Packing List	21
Table 6-1: OSD Menus	62

Chapter

1

Introduction

1.1 RPC-6010G Overview

The RPC-6010G is a PC/AT compatible computer designed for industrial applications. It has a rugged steel chassis specially designed to work under harsh environmental conditions while also being high reliability. The RPC-6010G supports 14-slot passive backplanes, ATX motherboards and a full line of dependable AC/DC power supplies. The RPC-6010G can withstand shock, vibration, dust and a wide range of temperatures in industrial environments. A lockable door protects drive bays and switches from unauthorized misuse and dust. The RPC-6010G also has two removable cooling-fans installed in the front panel for optimum cooling of the system.

1.2 RPC-6010G Features

Some of the features of the RPC-6010G include:

- 8.4" TFT LCD with fully functional OSD and membrane keypads
- Flexible driver combination
- Lockable front door
- USB x2 on the front panel
- PICMG 1.3 backplane and Redundant power supply support
- Advanced air-flow design

1.3 Model Variations

The RPC-6010G comes in a variety of models. The models have special features as identified by their model name. The RPC-6010G model variations are listed in **Table 1-1**.

Model	Touch Screen	SBC Form Factor	Expansion Slots
ACE-832AP-RS (ATX) Power Supply			
RPC-6010GW/ACE-832AP	No	Full-size CPU card	14
RPC-6010GW/ACE-832AP/T-R	Yes	Full-size CPU card	14
RPC-6010GWATX/ACE-832AP	No	ATX / microATX	7
RPC-6010GWATX/ACE-832AP/T-R	Yes	ATX / microATX	7

RPC-6010G Rackmount LCD Workstation

Model	Touch Screen	SBC Form Factor	Expansion Slots
ACE-R4140AP Redundant Power Supply			
RPC-6010GWR/ACE-R4140AP	No	Full-size CPU card	14
RPC-6010GWR/ACE-R4140AP/T-R	Yes	Full-size CPU card	14
RPC-6010GWATXR/ACE-R4140AP	No	ATX / microATX	7
RPC-6010GWATXR/ACE-R4140AP/T-R	Yes	ATX / microATX	7

Table 1-1: RPC-6010G Model Variations

1.4 Certifications

All RPC-6010G rackmount workstations comply with the following international standards:

- RoHS

For a more detailed description of this standard, please refer to **Appendix A**.



THIS PAGE IS INTENTIONALLY LEFT BLANK

Chapter

2

Mechanical Overview

2.1 External Overview

The following sections describe the physical layout of the RPC-6010G rackmount workstation.

2.1.1 Front Panel

The RPC-6010G rackmount workstation has the following front panel items:

- Plastic frame
- 8.4" Flat panel TFT LCD screen
- Lockable drive bay access door with 62 key membrane keypad and OSD controls conceals:
 - Three 5.25" drive bays
 - One 3.5" drive bay
 - Power switch
 - 2 USB connectors
 - Power and HDD LEDs
 - Reset button



Figure 2-1: RPC-6010G Front Panel

RPC-6010G Rackmount LCD Workstation



Figure 2-2: RPC-6010G Front Panel Door Open (Drives Not Included)

2.1.2 Rear Panel

The RPC-6010G rackmount workstation is available with either a 14-slot rear panel bracket or an ATX motherboard rear panel bracket. The following sections list the 14-slot rear panel bracket and ATX motherboard rear panel bracket items.

2.1.2.1 14-Slot Rear Panel

The 14-slot rear panel has the following rear panel items:

- Internal PSU
- 14 expansion slots
- VGA connector
- PS/2 mouse connector
- Optional Touch Screen connector

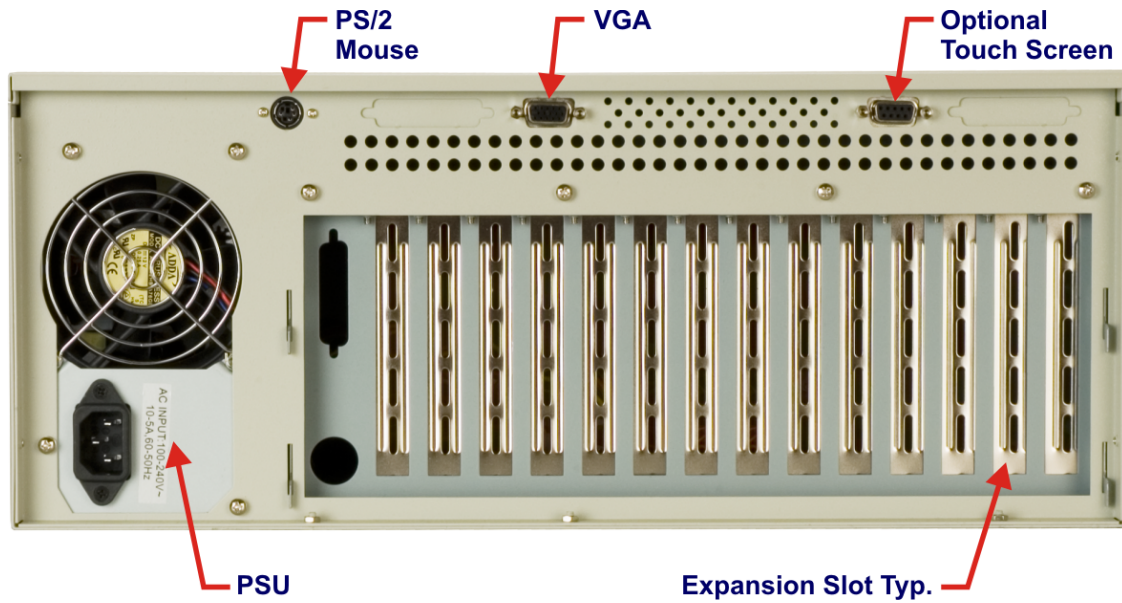

Figure 2-3: RPC-6010G 14 Slot Rear Panel

2.1.2.2 ATX Motherboard Rear Panel

The RPC-6010G rackmount workstation is available with two types of rear panel brackets. The ATX motherboard rear panel has the following rear panel items:

- Internal PSU
- 7 expansion slots
- VGA connector
- PS/2 mouse connector
- Optional Touch Screen connector
- ATX Motherboard connector area

RPC-6010G Rackmount LCD Workstation

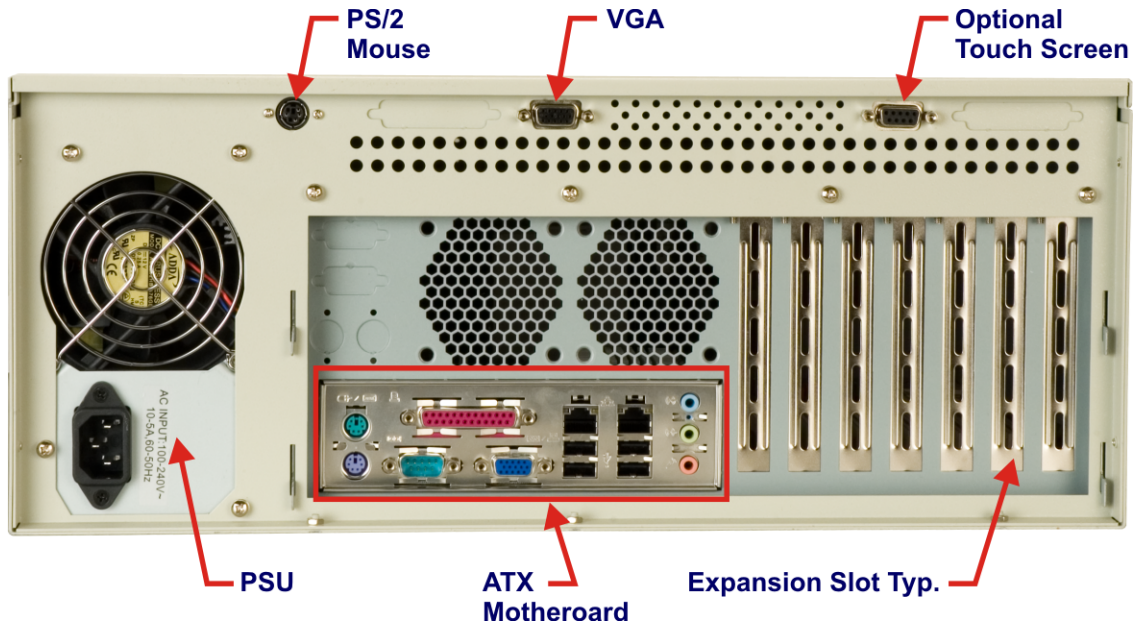

Figure 2-4: RPC-6010G ATX Motherboard Rear Panel

2.1.3 Right Side Panel

The RPC-6010G rackmount workstation has the following right side panel items:

- Cooling vents

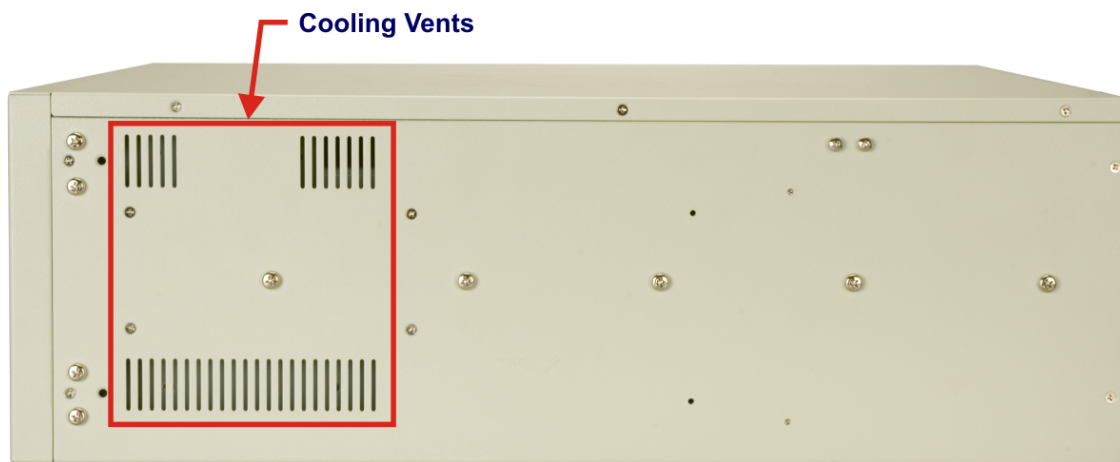

Figure 2-5: RPC-6010G Right Side Panel

2.1.4 Left Side Panel

The RPC-6010G rackmount workstation has the following left side panel items:

- Cooling vents



Figure 2-6: RPC-6010G Left Side Panel

2.2 Physical Dimensions

The following sections describe the physical dimensions of the RPC-6010G.

2.2.1 General Physical Dimensions

General physical dimensions for the RPC-6010G are shown in **Table 2-1**.

Width (mm)	Height (mm)	Depth (mm)
431	177	528

Table 2-1: General Physical Dimensions

RPC-6010G Rackmount LCD Workstation

2.2.2 RPC-6010G Physical Dimensions

The physical dimensions of the RPC-6010G are shown in **Figure 2-1**.

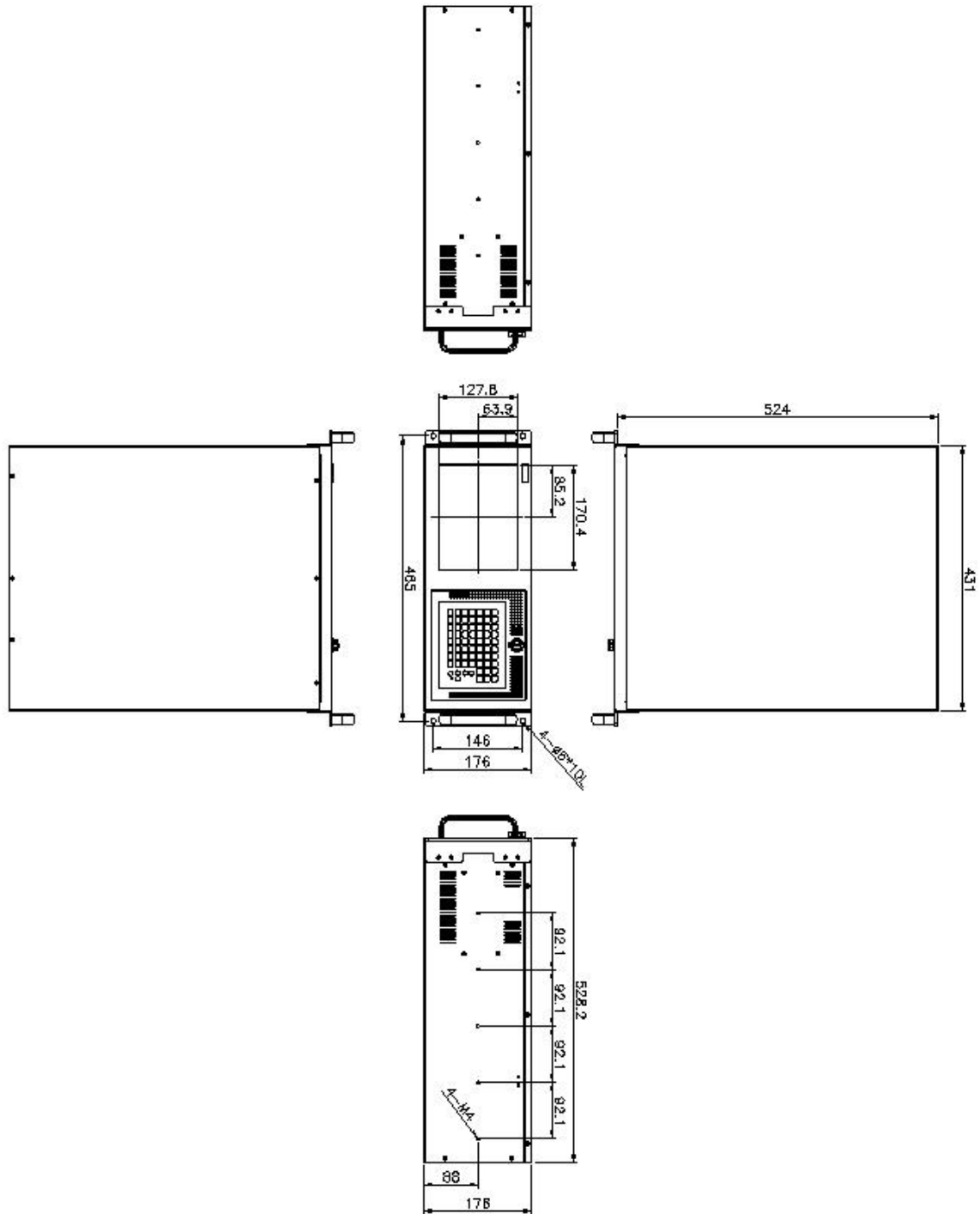

Figure 2-7: RPC-6010G Physical Dimensions (millimeters)



THIS PAGE IS INTENTIONALLY LEFT BLANK

Chapter

3

Detailed Specifications

3.1 RPC-6010G Specifications

Table 3-1 shows the RPC-6010G specifications.

LCD Type	8.4" TFT
Input Interface	VGA
Max. Resolution	800 x 600
Backlight MTBF	20,000 Hrs
Contrast	500:1
LCD Color	262K
Brightness (cd/m²)	220
Chassis	Heavy-duty steel
View Angle (H / V)	130 / 110
OSD function	Yes
Mounting	19" Rack Mount
Rack Height	4U
Cooling Fan	1 – 12cm
Expansion Slots	14 for RPC-6010G 7 for RPC-6010GATX
Dimensions (WxHxD) (mm)	431 x 177 x 528
Weight (Gross/Net)	15kg / 18kg
Color	White
Vibration	5 ~ 17 Hz, 0.1" double amplitude displacement 17 ~ 640 Hz, 1.5G acceleration peak to peak
Shock	10G acceleration peak to peak (11ms)
Humidity	5 ~ 95%, relative
Operation Temperature	0 ~ 50°C

Table 3-1: RPC-6010G Specifications

3.2 LCD Specifications

Table 3-2 lists the RPC-6010G LCD specifications.

Size	8.4"
MFR/Model	AUO/G084SN03
Resolution	SVGA (800 x 600)
Active Area (mm)	170.4 x 127.8
Pixel Pitch (mm)	0.213
Number of Colors	262K
View Angle (H/V)	130 / 110
Brightness (cd/m²)	220
Contrast Ratio	500:1
Response Time (ms) (at 25C)	35
Power Consumption (W)	3.3
Interface	1ch LVDS
Supply Voltage (V)	3.3
Backlight	1 CCFL
Lamp Life (hrs)	20,000

Table 3-2: LCD Specifications

3.3 ACE-832AP PSU Specifications

Table 3-3 lists the ACE-832AP power supply specifications.

INPUT	Voltage	90 ~ 264VAC Full Range		
	Frequency	50 ~ 60Hz		
	Input Current	6A(RMS)@115VAC 3A(RMS)@230VAC		
	Inrush Current	60A Max for 115VAC 90A Max for 230VAC		
OUTPUT	Voltage	Min. load	Max. load	Ripple & Noise
	+3.3V	0.3A	28A	50mV
	+5V	0.1A	30A	50mV
	+12V	0A	15A	120mV
	-5V	0A	0.3A	100mV
	-12V	0A	0.8A	120mV
	+5Vsb	0A	2A	100mV
	Total Current of +3.3V & +5V & +12V \leq 280W			
GENERAL	Power	300W		
	PFC	Active		
	Hold-up Time	17ms minimum		
	Efficiency	65%		
	MTBF	50,000hrs		
	Temperature	0 ~ 50°C (Operating) -20 ~ 80°C (Storage)		
	Dimensions	140 x 150 x 86mm		

Table 3-3: ACE-832AP PSU Specifications

3.4 Recommended IEI Backplanes, Motherboards and PSUs

Refer to **Appendix B** for recommended IEI backplanes, motherboards and power supply units for the RPC-6010G rackmount workstation.

Chapter

4

Installation

4.1 Installation Considerations

4.1.1 Installation Precautions

When installing the RPC-6010G, please follow the precautions listed below:

- **Read the user manual:** The user manual provides a complete description of the RPC-6010G rackmount workstation, installation instructions and configuration options.
- **Turn Off Power:** When installing the RPC-6010G rackmount workstation, make sure the power is off. Failing to turn off the power may cause severe injury to the user and/or damage the system.
- **Certified Engineers:** Only certified engineers and technicians should install and modify the RPC-6010G rackmount workstation. Non-certified engineers or technicians should not attempt to install the RPC-6010G rackmount workstation.
- **Mounting:** The RPC-6010G rackmount workstations are heavy devices. When rack mounting the RPC-6010G rackmount workstation, please ensure that at least two people are assisting with the procedure.
- **Anti-static Discharge:** Electronic components like CPU cards and backplanes must be installed into the RPC-6010G rackmount workstation. Follow proper grounding procedures before installing these components.

4.1.2 Installation Prerequisites

Prepare the following before installing the RPC-6010G rackmount workstation:

- **Completely installed CPU card:** The RPC-6010G rackmount workstation CPU card is separately purchased. Before installing the RPC-6010G rackmount workstation, a CPU card should be properly installed. The following components may also have to be installed (refer to the user manual that came with the CPU card):
 - CPU
 - Heatsink and cooling fan
 - Memory modules (DIMMs)
 - Compact flash disks

RPC-6010G Rackmount LCD Workstation

- **Backplane/Motherboard:** The backplane or motherboard installed in the RPC-6010G rackmount workstation is separately purchased.
- **Disk Drives:** Disk drives installed into the RPC-6010G rackmount workstation are separately purchased. Disk drive support is CPU card dependent. Before purchasing a CPU card or disk drives, please check the CPU card disk drive support.

4.2 Unpacking

4.2.1 Packaging

When shipped, the RPC-6010G rackmount workstation is wrapped in a plastic bag. Two polystyrene ends are placed on either side of the RPC-6010G rackmount workstation. The workstation is then placed into a first (internal) cardboard box. This box is then sealed and placed into a second (external) cardboard box. The second box is also sealed. A small box containing accessory items is placed within the internal (first) box.

4.2.2 Unpacking Procedure

To unpack the RPC-6010G rackmount workstation, follow the steps below:



NOTE:

The front side LCD screen has a protective plastic cover stuck to the screen. Remove the plastic cover only after the RPC-6010G rackmount workstation has been properly installed. This ensures the screen is protected during the installation process.

Step 1: Use box cutters, a knife or a sharp pair of scissors to open the top of the external (second) box.

Step 2: Open the external (second) box.

- Step 3:** Use box cutters, a knife or a sharp pair of scissors to open the top of the internal (first) box.
- Step 4:** Lift the workstation out of the boxes.
- Step 5:** Remove both polystyrene ends from each side.
- Step 6:** Pull the plastic cover off the workstation.
- Step 7:** Make sure all the components listed in the packing list are present.



4.2.3 Packing List



NOTE:

If some of the components listed in the checklist below are missing, please do not proceed with the installation. Contact the IEI reseller or vendor you purchased the AC-KIT-883HD audio module from or contact an IEI sales representative directly. To contact an IEI sales representative, please send an email to sales@iei.com.tw.

When the RPC-6010G rackmount workstation is received, make sure all the components listed below are present.

Quantity	Description	Image
1	Backplane to SBC connector cable	
2	Door key	
2	Handle	

RPC-6010G Rackmount LCD Workstation











Quantity	Description	Image
2	Handle bracket	
1	Mini-DIN 6 PS/2 connector cable	
1	Power cable	
1	Screw kit	
7	Short card clamp	
1	VGA cable	
2	4-pin USB wire cable	
For Touch Panel (T-R) Models only		
1	RS-232 cable	
1	TouchKit Driver CD	
1	Touch pen	

Table 4-1: Packing List

4.3 Pre-installation Preparation

4.3.1 System Planning

User supplied CPU cards and backplanes or motherboards need to be installed in the system before installing the RPC-6010G rackmount workstation.

The backplane determines the following system parameters:

- CPU card type
- Expandability

The CPU card determines the following system parameters:

- CPU
- Embedded graphics
- System memory
- HDD, FDD and optical drive connectivity and capacity
- Speed

It is therefore proper to correctly specify the system before the system is installed. This ensures that prudent selections can be made when the system is being developed.

4.3.2 Tools

Before installing the RPC-6010G rackmount workstation, make sure the following tools are on hand:

- **Philips (crosshead) screwdriver:** All the retention screws on the system are Philips screws.
- **Soft working mat:** When installing the RPC-6010G rackmount workstation, the screen should be placed face down on a soft working mat.

4.4 Installation Procedures

4.4.1 Preinstalled Components

The following components are preinstalled in the RPC-6010G rackmount workstation.

- Power supply unit (PSU)
- Cooling fan module
- Drive bracket
- LCD screen

4.4.2 User Installed Components

The following user supplied components need to be installed into the RPC-6010G rackmount workstation:

- Disk drives
- Backplane and CPU card, or motherboard
- PCI or ISA expansion cards (optional)

4.4.3 Installation Steps

Complete the following steps to properly install the workstation:

Step 1: Open the top cover.

Step 2: Remove the CPU card clamp.

Step 3: Remove the dual CPU card clamp and drive bay stabilizer bracket.

Step 4: Remove the disk drive bracket.

Step 5: Install the disk drives.

Step 6: Reinstall the disk drive bracket with the installed disk drives.

Step 7: Install the backplane.

Step 8: Install the CPU card.

Step 9: Install the PCI or ISA expansion cards (optional).

Step 10: Connect all required cables.

Step 11: Reinstall the dual CPU card clamp and drive bay stabilizer bracket.

Step 12: Reinstall the CPU card clamp.

Step 13: Close the top cover.

Step 14: Mount the workstation.

4.5 Installing Components into the RPC-6010G



NOTE:

This section gives a generic description of the component installation process for the RPC-6010G rackmount workstation.



WARNING:

Failure to follow the installation procedures outlined in this section may cause severe damage to the RPC-6010G rackmount workstation. Please follow the installation instructions carefully.

RPC-6010G Rackmount LCD Workstation

4.5.1 Remove the Top Cover

The top cover is secured to the RPC-6010G rackmount workstation with six screws (three each on the left and right panels). To remove the top cover, please follow the steps below.

Step 1: Remove the six top cover retention screws (three each on the left and right panels). (See **Figure 4-1**)



Figure 4-1: Top Cover Left Side Retention Screws (Right Side Similar)

Step 2: Remove the top cover from the chassis to reveal the internal components. (See **Figure 4-2**)



Figure 4-2: Remove Top Cover from Chassis

4.5.2 Remove the CPU Card Clamp

The CPU card clamp is secured to the RPC-6010G rackmount workstation with four retention screws. To remove the CPU card clamp, please follow the steps below.

Step 1: Remove four retention screws, two each on the left and right sides of the workstation, that secure the CPU card clamp to the chassis (**Figure 4-3**).



Figure 4-3: CPU Card Clamp Right Side Retention Screws (Left Side Similar)

Step 2: Remove the CPU card clamp from the chassis.

4.5.3 Remove the Dual CPU Card Clamp & Drive Bay Stabilizer Bracket

The dual CPU card clamp and drive bay stabilizer bracket is secured to the RPC-6010G rackmount workstation with 10 retention screws. To remove the dual CPU card clamp and drive bay stabilizer bracket, please follow the steps below.

Step 1: Remove the six retention screws that secure the dual CPU card clamp and drive bay stabilizer bracket to the sides of the workstation chassis (**Figure 4-4**).

RPC-6010G Rackmount LCD Workstation

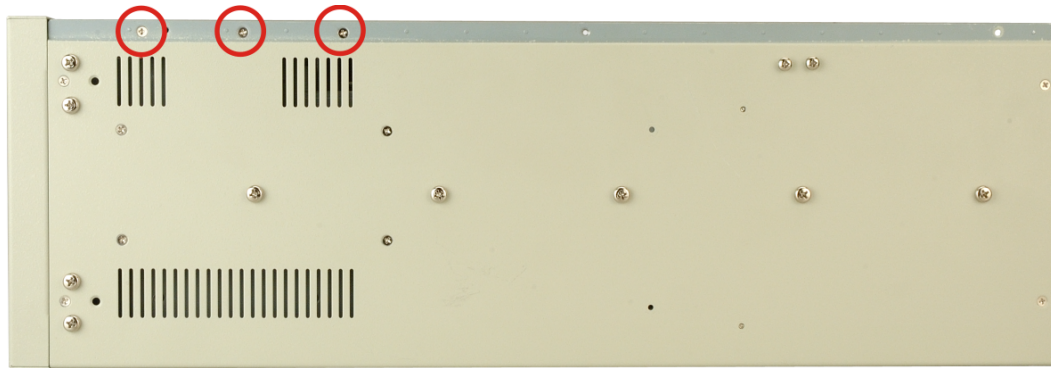

**Figure 4-4: Dual CPU Card Clamp and Drive Bay Stabilizer Bracket
Right Side Retention Screws (Left Side Similar)**

Step 2: Remove the four retention screws that secure the dual CPU card clamp and drive bay stabilizer bracket to the fan bracket (**Figure 4-5**).



**Figure 4-5: Dual CPU Card Clamp and Drive Bay Stabilizer Bracket to
Fan Bracket Retention Screws**

Step 3: Remove the CPU card clamp and drive bay bracket from the chassis.

4.5.4 Remove the Drive Bracket

The drive bracket is secured to the RPC-6010G rackmount workstation with four retention screws. To remove the drive bracket, please follow the steps below.

Step 1: Remove four retention screws that secure the drive bracket to the chassis (Figure 4-4).

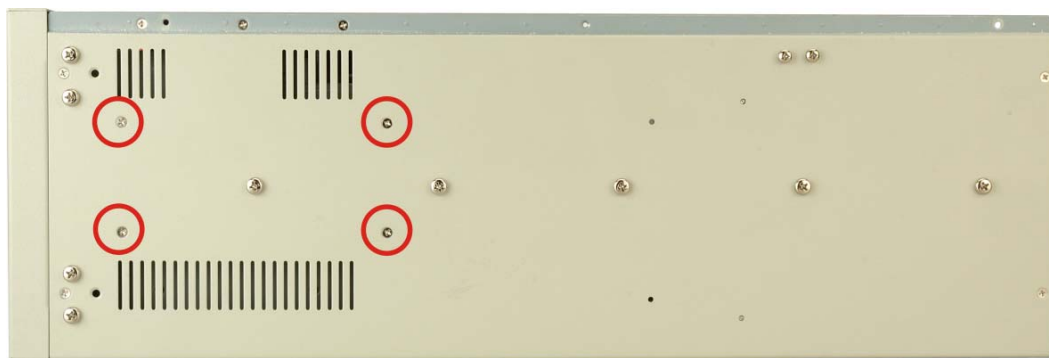

Figure 4-6: Drive Bracket Retention Screws

Step 2: Remove the drive bracket from the chassis.

4.5.5 Remove the Drive Slot Blank Plate

The drive bracket has three 5.25" and one 3.5" drive slot blank plates. To remove the drive slot blank plates, please follow the steps below.

Step 1: Remove the retention screws from each side of the drive bracket that secure the drive slot blank plates to the drive bracket (Figure 4-5).

RPC-6010G Rackmount LCD Workstation

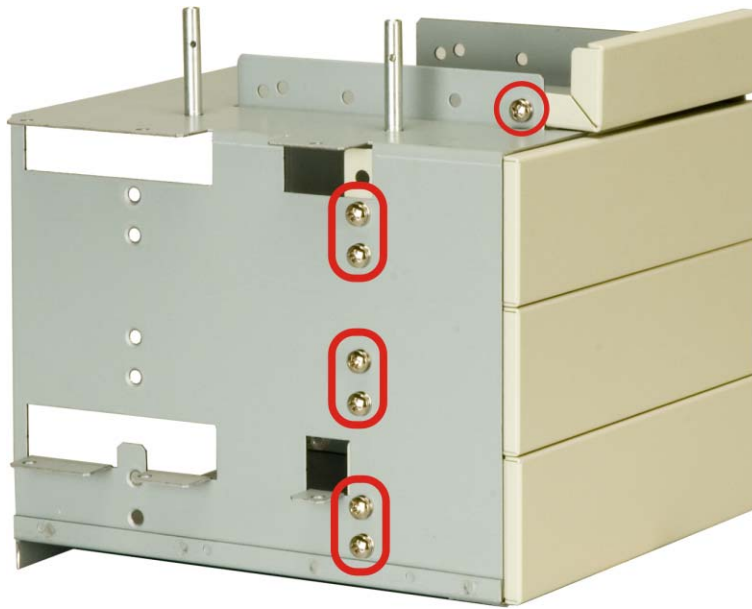

Figure 4-7: Drive Slot Blank Plate Retention Screws (Other Side Similar)

Step 2: Remove the drive slot blank plate from the drive bracket.

4.5.6 Install Drives

4.5.6.1 5.25" Disk Drive

The drive bracket supports three 5.25" disk drives. To install a 5.25" disk drive, follow the instructions below.

Step 1: Remove the dual CPU card clamp and drive bay stabilizer bracket from the RPC-6010G rackmount workstation (see **Section 4.5.3**).

Step 2: Remove the drive bracket from the RPC-6010G rackmount workstation (see **Section 4.5.4**).

Step 3: Remove the appropriate drive slot blank plate (see **Section 4.5.5**).

Step 4: Slide the 5.25" disk drive into the drive bracket. Make sure the IDE/SATA connector and the power connector of the drive are facing the rear of the bracket.

Step 5: Insert the appropriate number of retention screws into each side of the 5.25" disk drive through the drive bracket (**Figure 4-8**).



Figure 4-8: 5.25" Disk Drive Retention Screws (Other Side Similar)

4.5.6.2 3.5" Disk Drive in a 5.25" Slot

With the use of IEI's 3.5" to 5.25" drive bay rack, a standard 3.5" disk drive can be installed into a 5.25" drive bay slot. To install a 3.5" hard disk drive into a 5.25" slot of the drive bracket, follow the instructions below.

- Step 1:** Slide a 3.5" disk drive into a 3.5" to 5.25" drive bay rack. Make sure the IDE/SATA connector and the power connectors of the drive are facing the rear of the rack.
- Step 2:** Insert the appropriate number of retention screws into each side of the 3.5" disk drive through the 3.5" to 5.25" drive bay rack (**Figure 4-9**).

RPC-6010G Rackmount LCD Workstation



Figure 4-9: 3.5" to 5.25" Drive Bay Rack Retention Screws (Other Side Similar)

- Step 3:** Remove the dual CPU card clamp and drive bay stabilizer bracket from the RPC-6010G rackmount workstation (see **Section 4.5.3**).
- Step 4:** Remove the drive bracket from the RPC-6010G rackmount workstation (see **Section 4.5.4**).
- Step 5:** Remove the appropriate drive slot blank plate (see **Section 4.5.5**).
- Step 6:** Install the 3.5" to 5.25" drive bay rack into the drive bracket (see **Section 4.5.6.1**).

4.5.6.3 3.5" Disk Drive

To install a 3.5" disk drive, follow the instructions below.

- Step 1:** Remove the dual CPU card clamp and drive bay stabilizer bracket from the RPC-6010G rackmount workstation (see **Section 4.5.3**).
- Step 2:** Remove the drive bracket from the RPC-6010G rackmount workstation (see **Section 4.5.4**).
- Step 3:** If installing a floppy disk drive, remove the 3.5" drive slot blank plate (see **Section 4.5.5**).

Step 4: Slide a 3.5" disk drive into one of the 3.5" drive brackets. Make sure the connectors of the drive are facing the rear of the drive bracket.

Step 5: Insert the appropriate number of retention screws into each side of the 3.5" disk drive through the 3.5" drive bracket (**Figure 4-10**).

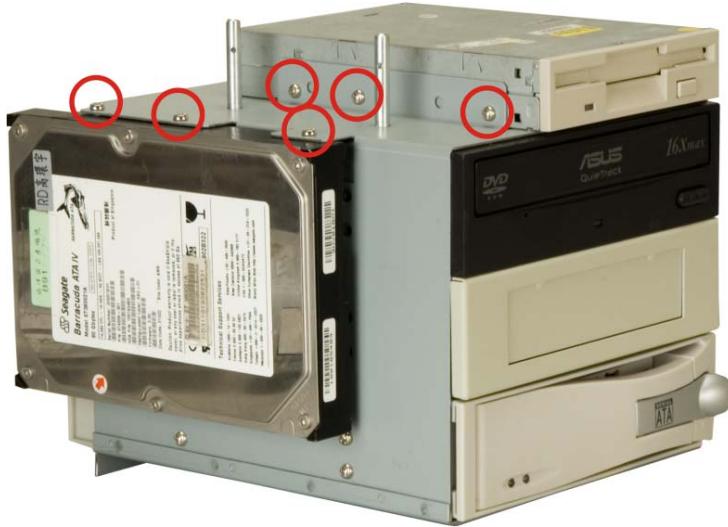

Figure 4-10: 3.5" Disk Drive Retention Screws

4.5.7 Reinstall the Drive Bracket

After the drives have been installed, reinstall the drive bracket into the chassis.



NOTE:

It might be easier to connect the disk drive IDE/SATA connectors to the ribbon cables and the disk drive power connectors to the PSU before the drive bracket is reinstalled into the chassis.

Step 1: Remount the drive bracket in the original position it was removed from.

Step 2: Make sure all drive bracket retention screw holes are properly aligned with the corresponding retention screw holes in the workstation.

Step 3: Reinsert all drive bracket retentions screws.

RPC-6010G Rackmount LCD Workstation

4.5.8 Install the Backplane

To install a backplane, follow the instructions below.

Step 1: Install the correct amount of copper pillars and plastic spacers into the base of the chassis (**Figure 4-11**).



NOTE:

The backplane shown in **Figure 4-11** is an example for reference only. The location and number of copper pillars and plastic spacers depends on the backplane being used.

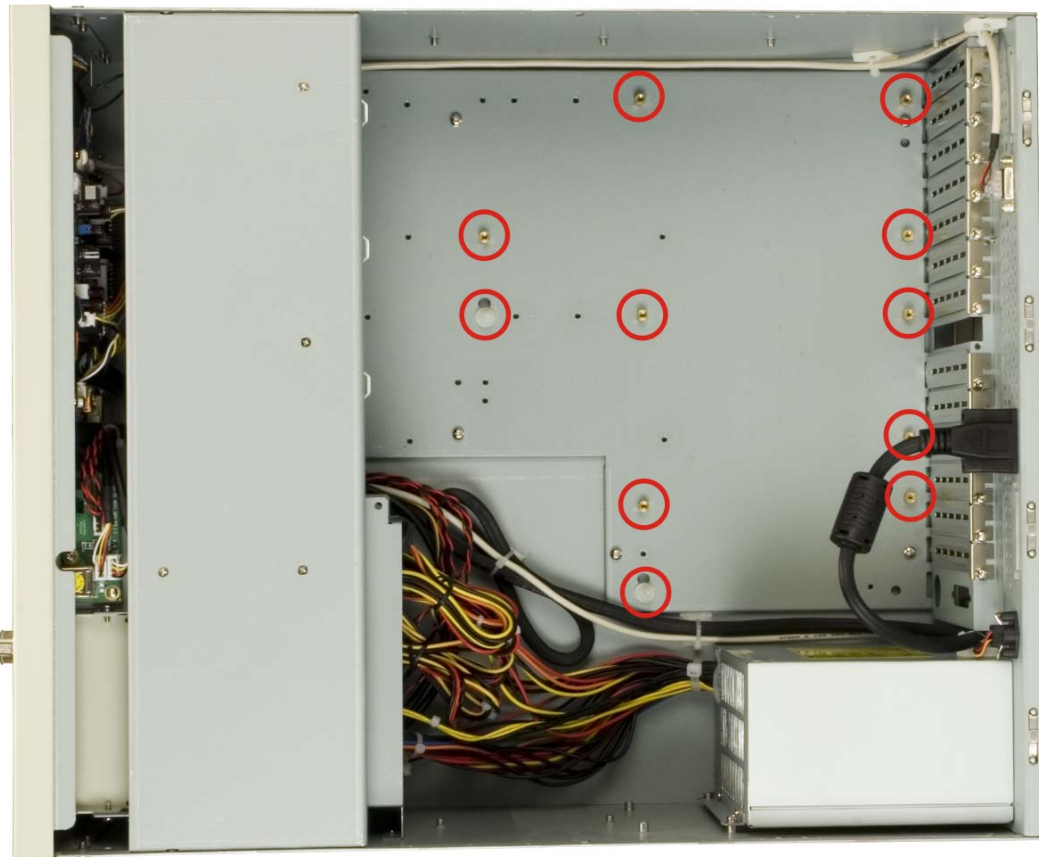

Figure 4-11: Install Copper Pillars and Plastic Spacers

- Step 2:** Mount the backplane into the chassis. Make sure the backplane is positioned so that when the CPU card and PCI/ISA expansion cards are installed, both the CPU card and the PCI/ISA card I/O connectors face the I/O brackets on the rear panel.
- Step 3:** Align the retention screw holes in the backplane with the copper pillars installed in **Step 1**.
- Step 4:** Insert retention screws to secure the backplane to the chassis (**Figure 4-12**)

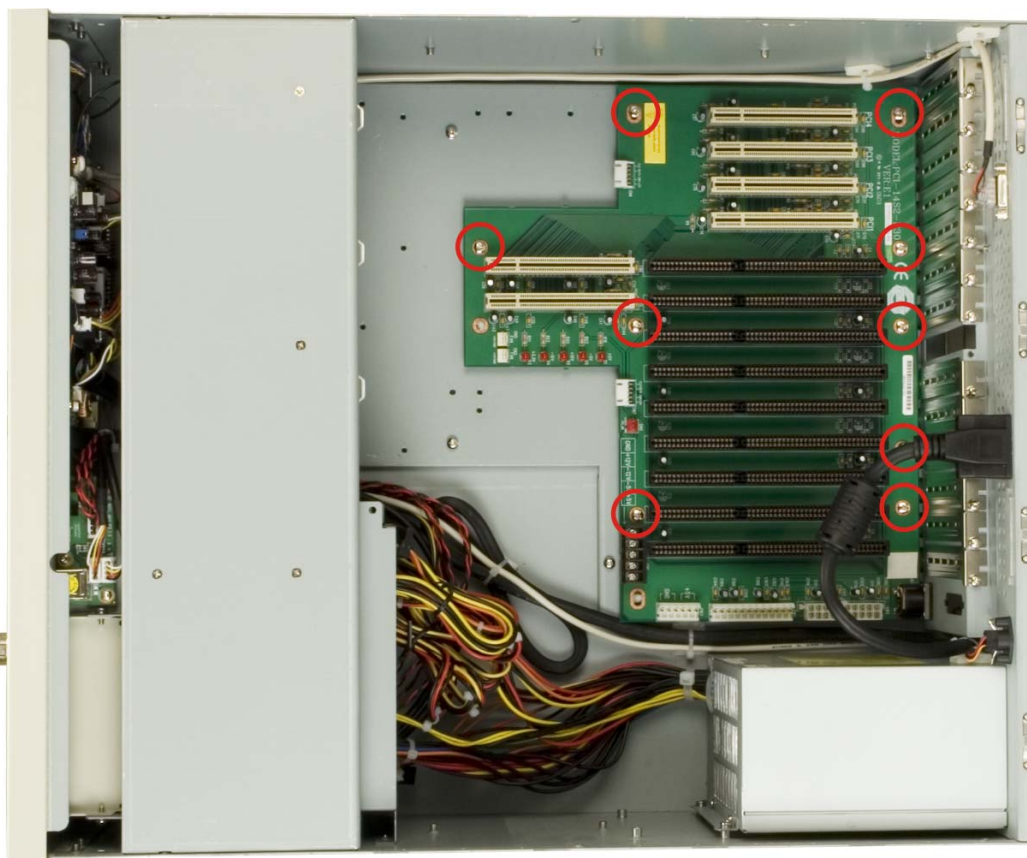

Figure 4-12: Backplane Retention Screws

4.5.9 Install the CPU Card



CAUTION

Before a CPU card is inserted into the backplane, make sure the CPU card has been correctly prepared and that all the CPU card jumper settings are configured correctly. For CPU card component installation procedures, please refer to the user manual that came with the CPU card.



CAUTION

Depending on the location of the CPU card, the disk drive ribbon cable connectors and other peripheral device cable connectors may have to be connected to the CPU card before it can be installed.

To install a CPU card onto the backplane, follow the instructions below:

- Step 1:** Remove the slot bracket from the chassis rear panel by removing the slot cover retention screw (**Figure 4-13**).

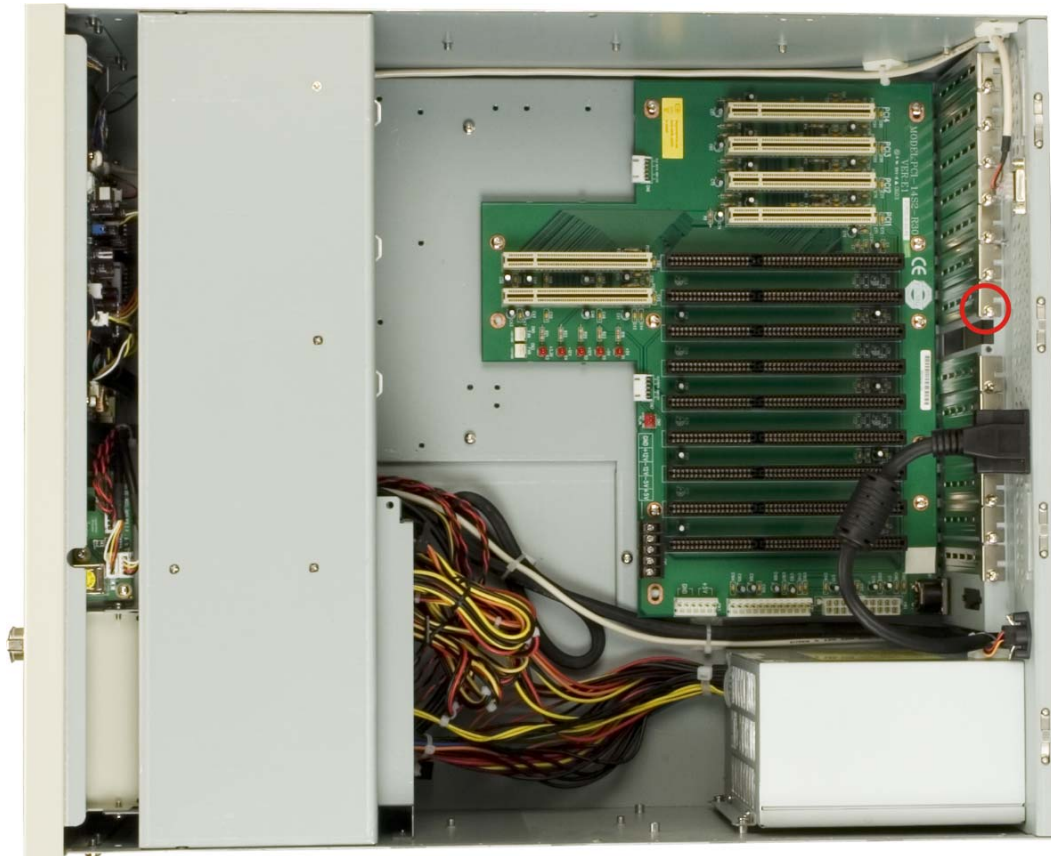

Figure 4-13: Slot Cover Retention Screw

- Step 2:** Remove the CPU card clamp. (See **Section 4.5.2**)
- Step 3:** Remove the dual CPU card clamp and drive bay stabilizer bracket. (See **Section 4.5.3**)
- Step 4:** Slide the CPU card into the reserved PCI/ISA socket on the backplane. Make sure the back edge of the CPU card slides into the plastic guide rails at the front end of the chassis.

RPC-6010G Rackmount LCD Workstation

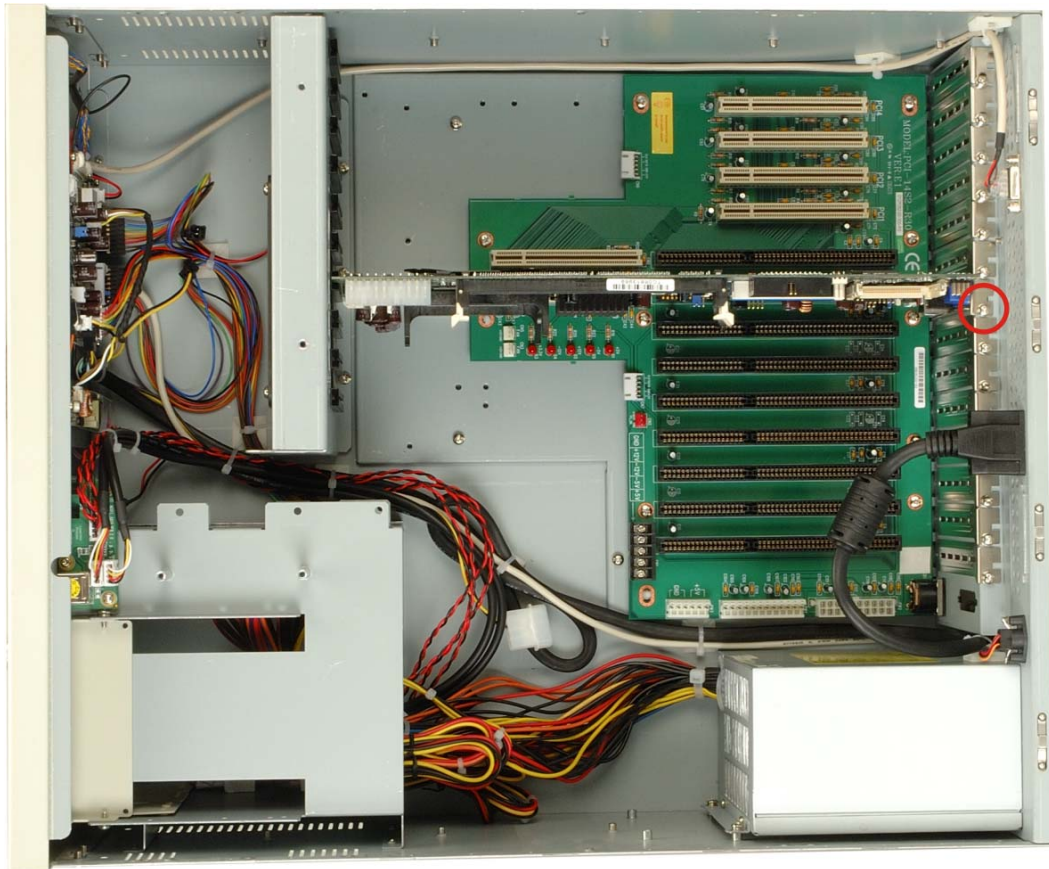

Figure 4-14: Install the CPU Card

Step 5: To secure the CPU card, reinsert the previously removed slot cover retention screw.

Step 6: If a PCI/ISA expansion card is not being installed, reinstall the dual CPU card clamp and drive bay stabilizer bracket and the CPU card clamp. If a PCI/ISA expansion card is being installed, proceed to the next section.

4.5.10 Install the PCI/ISA Expansion Card

To install a PCI expansion card or an ISA expansion card please follow the instructions below.

Step 1: Remove the slot cover retention screw to remove the slot bracket from the chassis rear panel (**Figure 4-13**).

- Step 2:** If necessary, remove the CPU card clamp. (See **Section 4.5.2**)
- Step 3:** If necessary, remove the dual CPU card clamp and drive bay stabilizer bracket.
(See **Section 4.5.3**)
- Step 4:** Slide the PCI/ISA expansion card into the reserved PCI/ISA socket on the backplane.
- Step 5:** To secure the PCI/ISA expansion card, reinsert the previously removed slot cover retention screw.
- Step 1:** If necessary, reinstall the CPU card clamp.
- Step 2:** If necessary, reinstall the dual CPU card clamp and drive bay stabilizer bracket.

4.5.11 Installing Short Cards

When installed, some cards may still fall short below the CPU card clamp. To better secure the CPU card or expansion cards, use the short card clamps that came with the workstation.

- Step 3:** Locate the screw hole on the CPU card clamp closest to the target card.
- Step 4:** Adjust the short card clamp in a vertical direction until the shock absorber part of the clamp secures the expansion card.
- Step 5:** Fasten a screw to secure the card clamp.

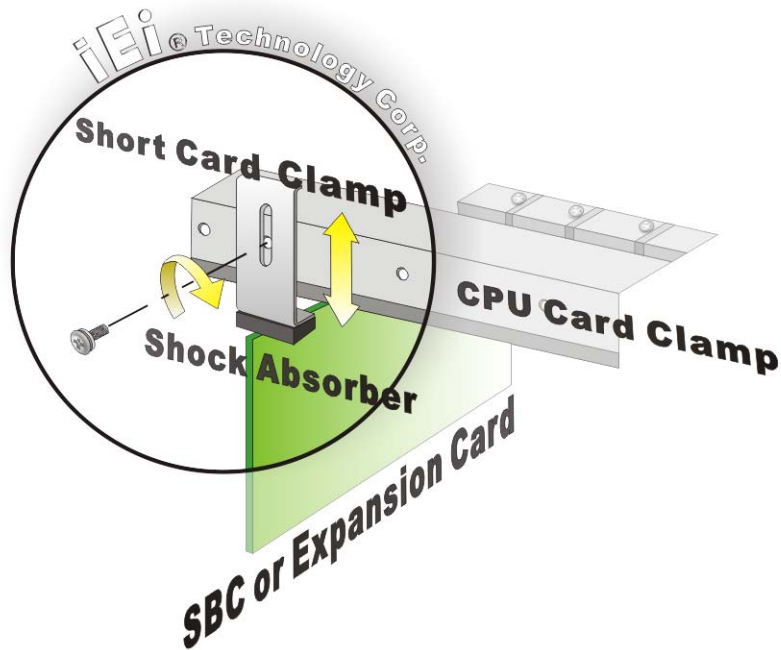

Figure 4-15: Installing a Short Card

4.5.12 Connect the Cables

The following cables may have to be connected depending on the CPU card and the backplane installed in the system:

- PSU cables must be connected to the following components (if installed):
 - CPU card
 - Backplane
 - FDD
 - HDD
 - Optical drive
- Disk drive ribbon cables must be connected to the corresponding CPU card disk drive connectors.

Other connections may have to be made; please refer to the documentation that came with the CPU card.

4.5.13 Close the Top Cover

Before closing the top cover, make sure the following items have been completed:

- The backplane is properly installed
- The CPU card is properly installed
- The PCI/ISA expansion cards are properly installed
- The disk drives are properly installed into the drive bracket
- The drive bracket is properly reinstalled into the workstation
- All cables are properly connected

If all of the above listed items have been properly installed, close the top cover and reinsert the previously removed retention screws.

4.6 Mounting the RPC-6010G Rackmount Workstation

The RPC-6010G workstation can be mounted to the posts of a standard 19" rack cabinet. Adequate rails, rack tray, or side brackets should also be available for supporting the weight of the workstation. Make sure that all cabling is correctly attached and carefully routed when installing the workstation.



NOTE:

At least two people are required to mount the workstation. The rack or cabinet into which the workstation is installed should provide adequate and sufficient ventilation, grounding, power source, and stability features.

RPC-6010G Rackmount LCD Workstation



NOTE:

This section gives a generic description of the rack mounting process for the RPC-6010G rackmount workstation. Alternate rack mounting systems may require different mounting procedures. Be sure to follow the manufacturer's instructions when mounting the workstation.

To rack mount the workstation, please follow the steps below.

Step 1: The left and right side panels of the workstation each have four screw holes for rack handle bracket installation. Assemble the rack handle brackets and secure them to the workstation. (See **Figure 4-16**)

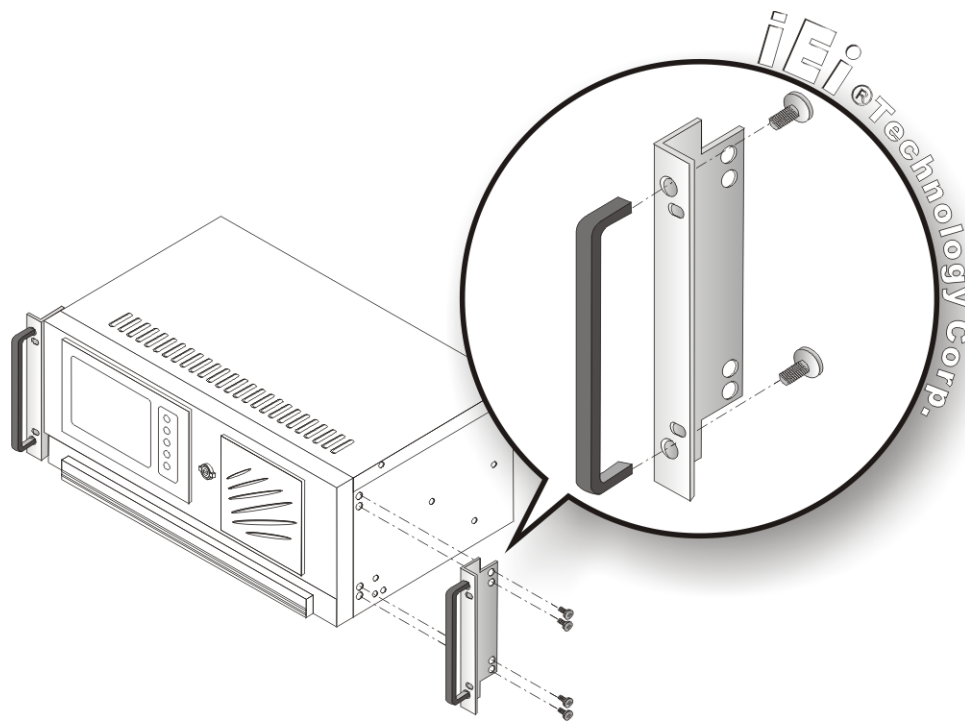

Figure 4-16: Rack Handle Bracket Assembly and Installation

Step 2: Remove the rack slides from the rack slide brackets. (See **Figure 4-17**)

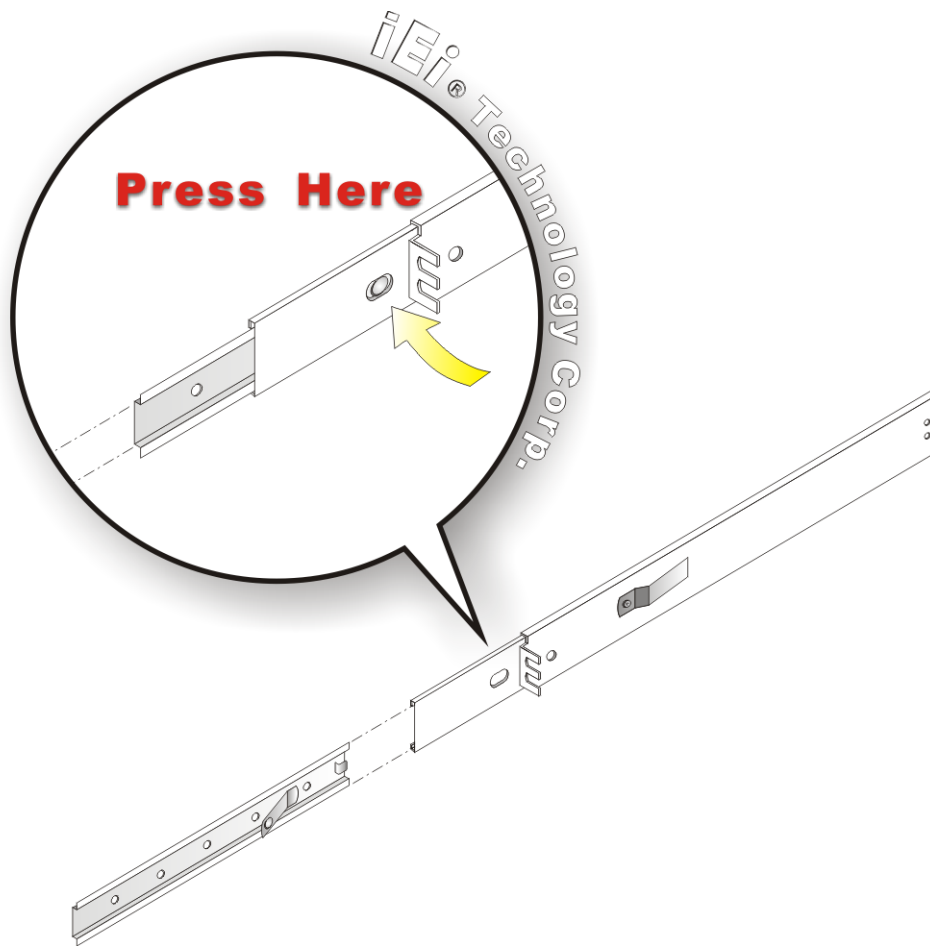

Figure 4-17: Remove Rack Slide

Step 3: The left and right side panels of the workstation each have five screw holes for rack slides. Attach one slide section each to the left and right side panel of the workstation. (See **Figure 4-16**)

RPC-6010G Rackmount LCD Workstation

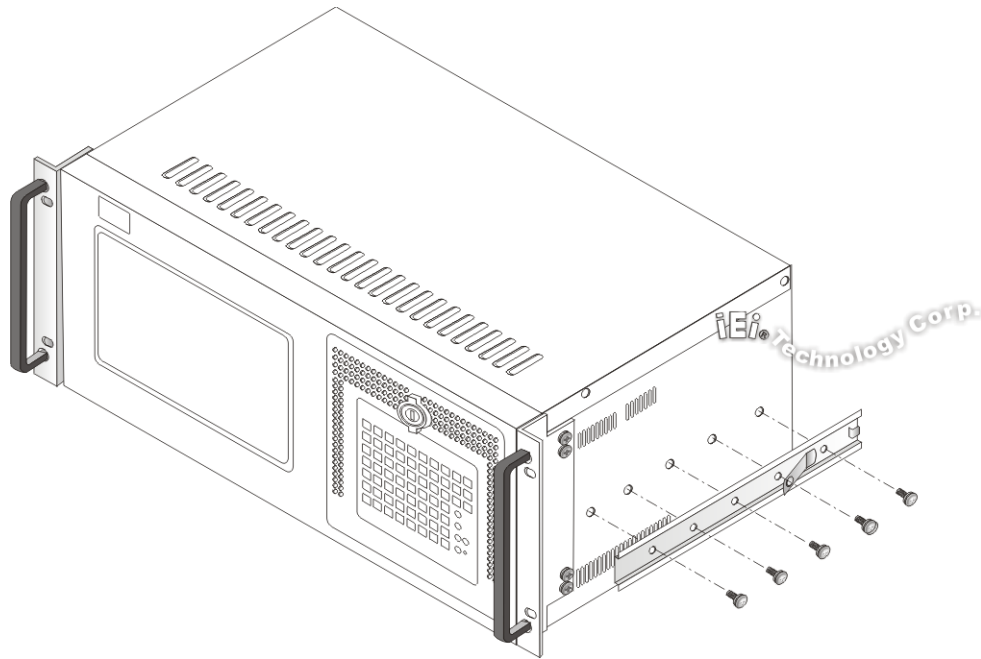

Figure 4-18: Workstation Slide Installation (Other Side Similar)

Step 4: Assemble the slide brackets per the manufacturer's instructions.

(See **Figure 4-19**)

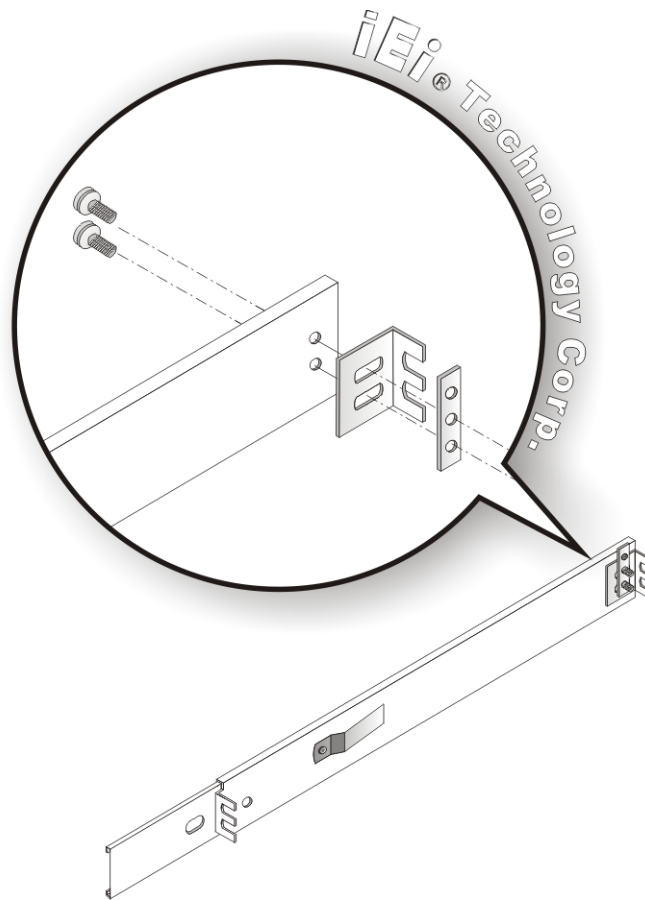

Figure 4-19: Rack Slide Bracket Assembly

Step 5: Attach the slide brackets to the rack per the manufacturer's instructions.

(See **Figure 4-20**)

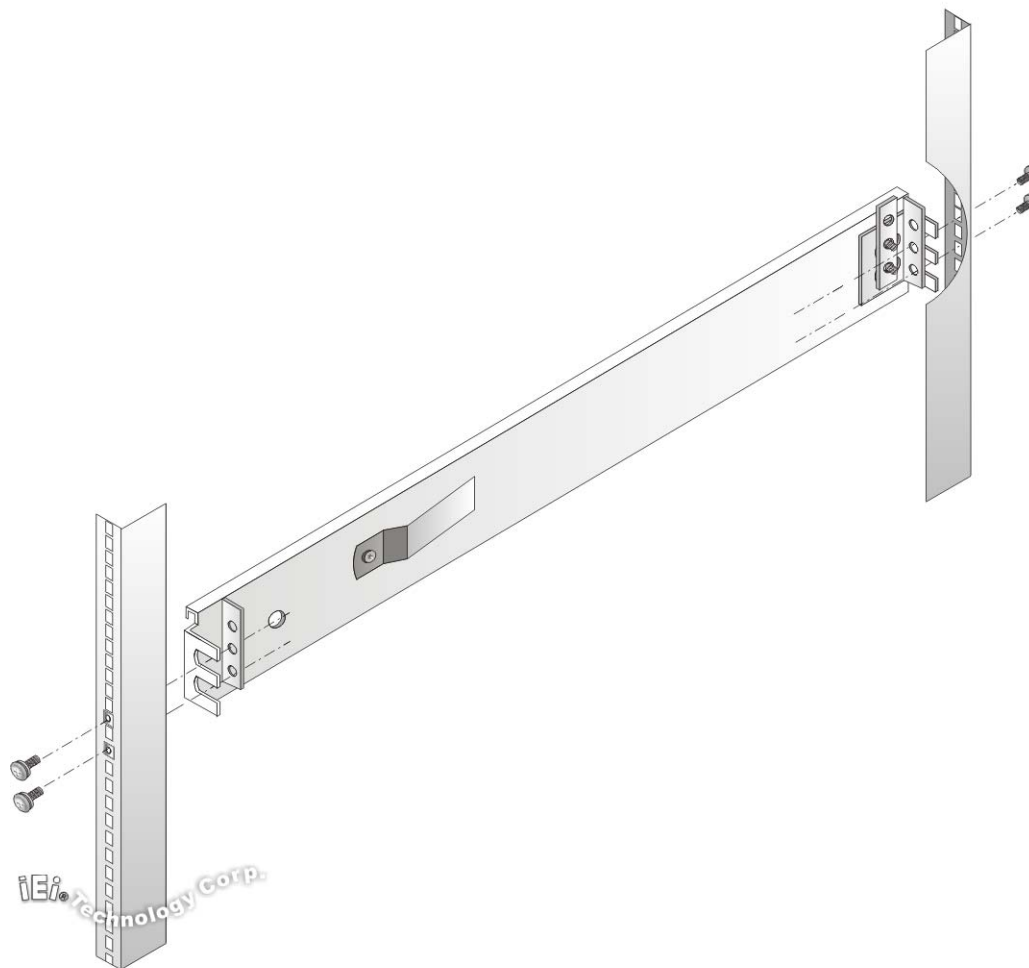

Figure 4-20: Rack Slide Bracket Installation

Step 6: Insert the workstation with the attached slides into the rack slide brackets until the handle brackets are flush against the rack. (See **Figure 4-21**)

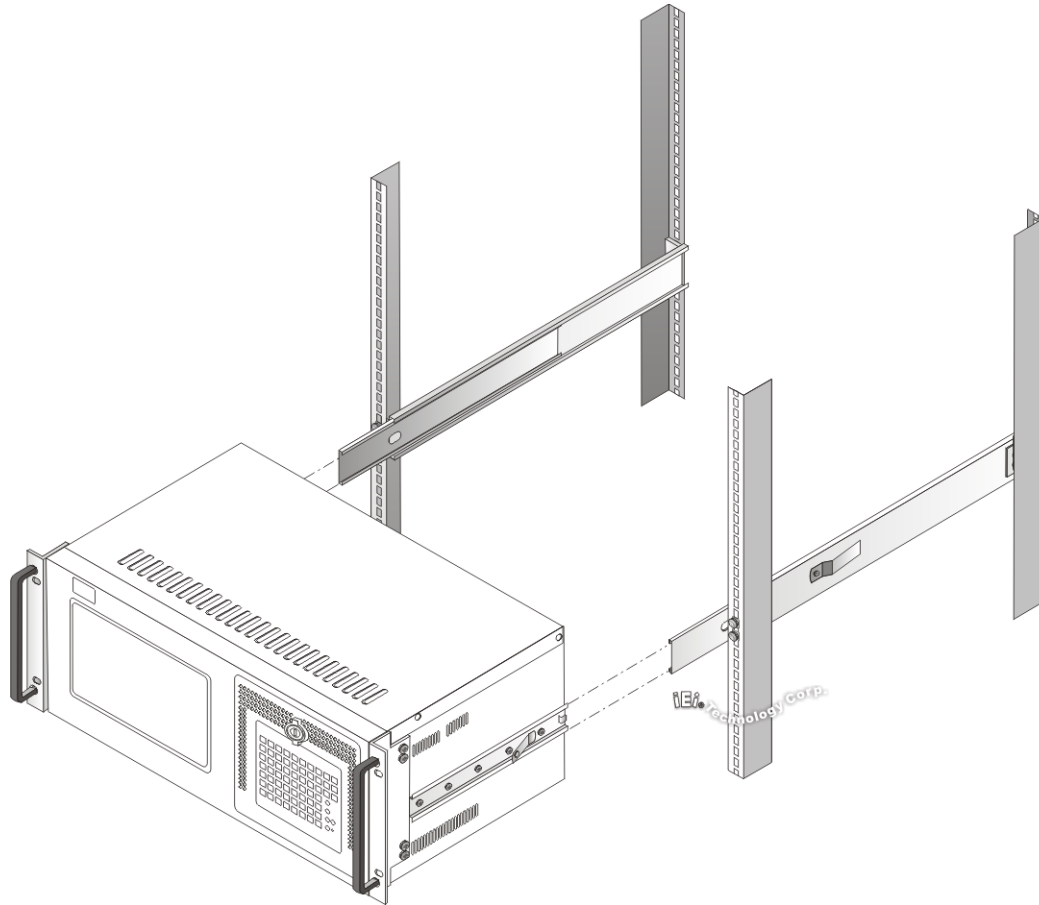

Figure 4-21: Install Workstation into Rack

Step 7: If necessary, secure the workstation handle brackets to the rack with the fasteners that came with the workstation.

Chapter

5

Maintenance

5.1 Maintenance Overview

Maintaining the RPC-6010G rackmount workstation is essential for the smooth operating of system applications. Maintaining the system might mean replacing failed components during the lifetime of the workstation. The following RPC-6010G components can be replaced.

- CPU card
- PCI/ISA expansion card
- Backplane
- Power supply unit (PSU)
- Cooling fans
- Disk drives
 - 3.5"
 - 5.25"



WARNING:

Never attempt to remove the external panels or access any internal components of the workstation while it is connected to a power source. Always be sure to turn off and disconnect the workstation from all power sources before attempting to access the internal components. Failure to do so may seriously injure the user or cause irreparable damage to the internal components of the workstation.

5.2 CPU Card Replacement

To replace a CPU card, please follow the instructions below.

Step 1: Turn off and disconnect the workstation from all power sources.

Step 2: Remove the workstation from the rack in which it is installed.

RPC-6010G Rackmount LCD Workstation

- Step 3:** Open the top cover of the RPC-6010G rackmount workstation.
(See **Section 4.5.1**)
- Step 4:** Disconnect all internal and external peripheral device connections from the CPU card.
- Step 5:** Remove the CPU card clamp. (See **Section 4.5.2**)
- Step 6:** Remove the dual CPU card clamp and drive bay stabilizer bracket. (See **Section 4.5.3**)
- Step 7:** Remove the retention screw that secures the CPU card to the slot on the rear panel.
- Step 8:** Slide the CPU card out of the workstation.
- Step 9:** Install a new CPU card. (See **Section 4.5.9**)
- Step 10:** Reinstall the CPU card clamp.
- Step 11:** Reinstall the dual CPU card clamp and drive bay stabilizer bracket.
- Step 12:** Reinstall the top cover of the workstation.
- Step 13:** Reinstall the workstation into the rack. Refer to **Section 4.6** for complete mounting instructions.

5.3 PCI/ISA Expansion Card Replacement

To replace a PCI/ISA expansion card, please follow the instructions below.

- Step 1:** Turn off and disconnect the workstation from all power sources.
- Step 2:** Remove the workstation from the rack in which it is installed.
- Step 3:** Open the top cover of the RPC-6010G rackmount workstation.
(See **Section 4.5.1**)
- Step 4:** Disconnect all internal and external peripheral device connections from the PCI/ISA expansion card.

- Step 5:** Remove the CPU card clamp. (See **Section 4.5.2**)
- Step 6:** Remove the dual CPU card clamp and drive bay stabilizer bracket. (See **Section 4.5.3**)
- Step 7:** Remove the retention screw that secures the PCI/ISA expansion card to the slot on the rear panel.
- Step 8:** Slide the PCI/ISA expansion card out of the workstation.
- Step 9:** Install a new PCI/ISA expansion card. (See **Section 4.5.10**)
- Step 10:** Reinstall the CPU card clamp.
- Step 11:** Reinstall the dual CPU card clamp and drive bay stabilizer bracket.
- Step 12:** Reinstall the top cover of the workstation.
- Step 13:** Reinstall the workstation into the rack. Refer to **Section 4.6** for complete mounting instructions.

5.4 Backplane Replacement

To replace a backplane, please follow the instructions below.

- Step 1:** Turn off and disconnect the workstation from all power sources.
- Step 2:** Remove the workstation from the rack in which it is installed.
- Step 3:** Open the top cover of the RPC-6010G rackmount workstation.
(See **Section 4.5.1**)
- Step 4:** Remove the CPU card clamp. (See **Section 4.5.2**)
- Step 5:** Remove the dual CPU card clamp and drive bay stabilizer bracket. (See **Section 4.5.3**)
- Step 6:** Disconnect and remove all CPU cards (see **Section 4.5.9**) and PCI/ISA expansion cards (see **Section 4.5.10**).

RPC-6010G Rackmount LCD Workstation

- Step 7:** Remove the retention screws that secure the backplane to the workstation (see **Section 4.5.8**).
- Step 8:** Install a new backplane into the chassis.
- Step 9:** Reinstall and reconnect all CPU cards (see **Section 4.5.9**) and PCI/ISA expansion cards (see **Section 4.5.10**).
- Step 10:** Reinstall the CPU card clamp.
- Step 11:** Reinstall the dual CPU card clamp and drive bay stabilizer bracket.
- Step 12:** Reinstall the top cover of the workstation.
- Step 13:** Reinstall the workstation into the rack. Refer to **Section 4.6** for complete mounting instructions.

5.5 PSU Replacement

To replace a PSU, please follow the instructions below.

- Step 1:** Turn off and disconnect the workstation from all power sources.
- Step 2:** Remove the workstation from the rack in which it is installed.
- Step 3:** Open the top cover of the RPC-6010G rackmount workstation.
(See **Section 4.5.1**)
- Step 4:** Remove the CPU card clamp. (See **Section 4.5.2**)
- Step 5:** Disconnect all the PSU cables from their devices.
- Step 6:** Remove the four external retention screws that secure the PSU assembly to the rear panel of the workstation (**Figure 5-1**).

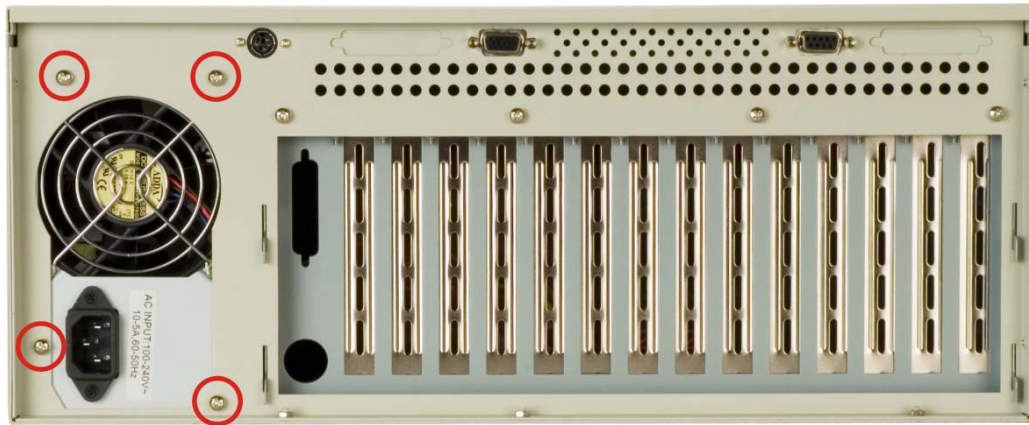

Figure 5-1: PSU External Retention Screws

Step 7: Remove the two internal retention screws that secure the PSU assembly to the right side panel of the workstation (**Figure 5-2**).

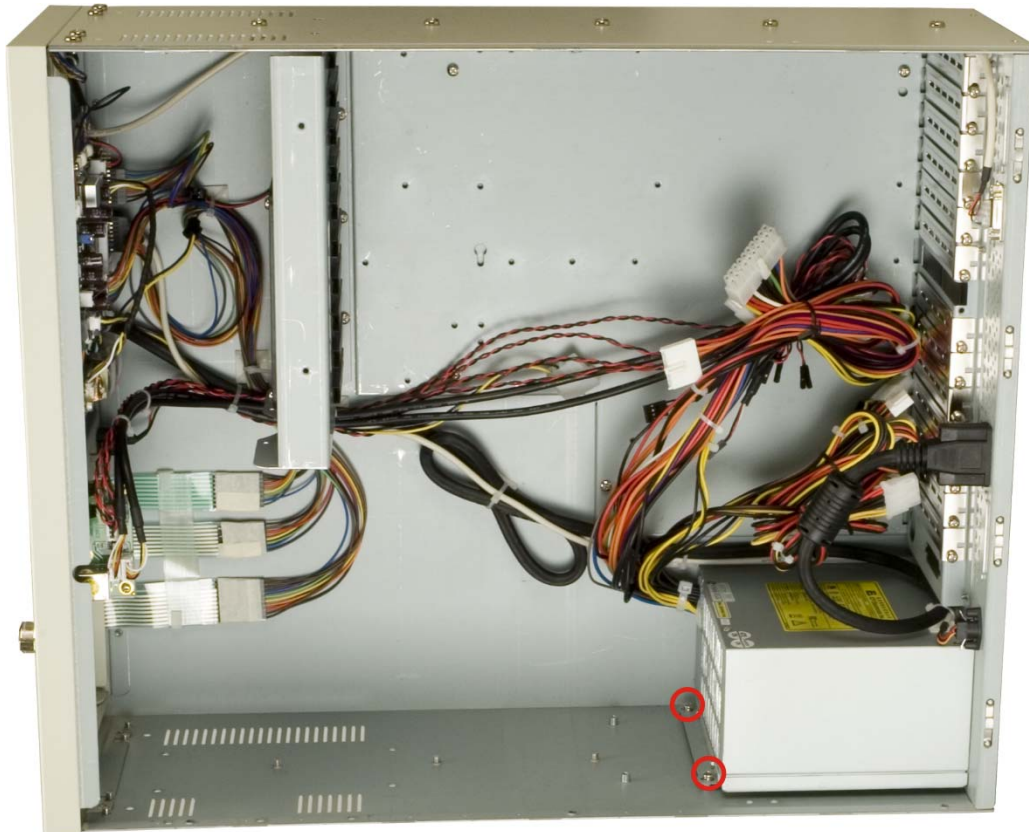

Figure 5-2: PSU Internal Retention Screws

RPC-6010G Rackmount LCD Workstation

Step 8: Remove the two retention screws on the PSU mounting bracket (**Figure 5-3**).



Figure 5-3: PSU Mounting Bracket Retention Screws

Step 9: Reattach the PSU mounting bracket to the new PSU with the two previously removed retention screws.

Step 10: Install the new PSU into the workstation making sure the PSU power connector and PSU cooling fan are facing out of the workstation.

Step 11: Reinsert the two previously removed internal retention screws that secure the PSU assembly to the right side panel of the workstation.

Step 12: Reinsert the four previously removed external retention screws that secure the PSU assembly to the rear panel of the workstation.

Step 13: Reinstall the CPU card clamp.

Step 14: Reinstall the top cover of the workstation.

Step 15: Reinstall the workstation into the rack. Refer to **Section 4.6** for complete mounting instructions.

5.6 Cooling Fan Replacement

To replace a cooling fan, please follow the instructions below.



CAUTION:

Carefully note the direction and orientation of the existing cooling fan prior to replacement.

-
- Step 1:** Turn off and disconnect the workstation from all power sources.
 - Step 2:** Remove the workstation from the rack in which it is installed.
 - Step 3:** Open the top cover of the RPC-6010G rackmount workstation.
(See **Section 4.5.1**)
 - Step 4:** Remove the CPU card clamp. (See **Section 4.5.2**)
 - Step 5:** Remove the dual CPU card clamp and drive bay stabilizer bracket. (See **Section 4.5.3**)
 - Step 6:** Disconnect and remove all CPU cards and PCI/ISA expansion cards.
 - Step 7:** Disconnect the cooling fan from the PSU.
 - Step 8:** Remove the two external retention screws that secure the cooling fan bracket to the left side panel of the workstation. (See **Figure 5-4**)

RPC-6010G Rackmount LCD Workstation



Figure 5-4: Cooling Fan Bracket External Screws

Step 9: Remove the three retention screws that secure the cooling fan bracket to the bottom of the workstation. (See **Figure 5-5**)

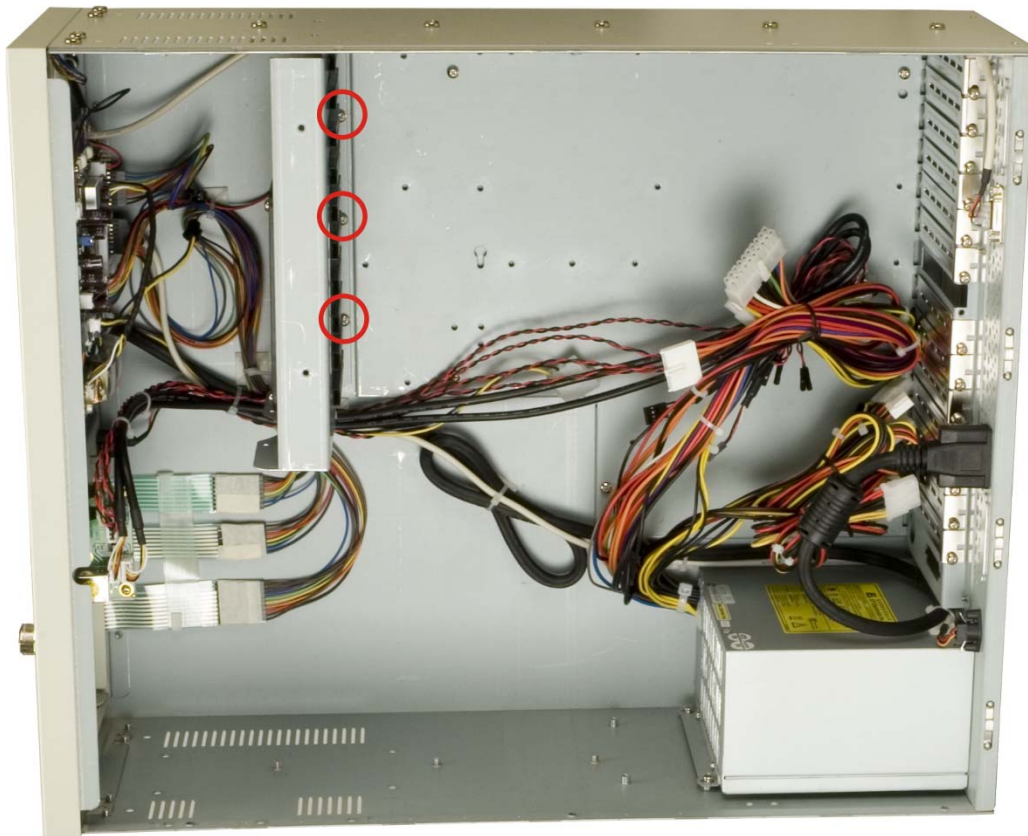

Figure 5-5: Cooling Fan Bracket Bottom Panel Screws

Step 10: Remove the fan from the bracket by removing the four retention screws.

(See **Figure 5-6**)

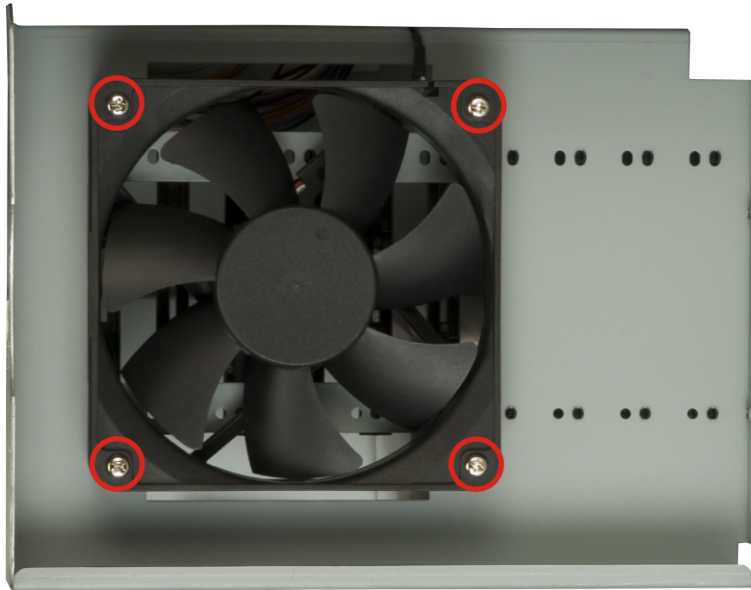

Figure 5-6: Fan Retention Screws

Step 11: Place the new fan into the bracket. Align the retention screw holes in the new fan with those in the bracket and reinsert the four retention screws.

Step 12: Connect the new cooling fan to the PSU.

Step 13: Reinstall the three retention screws that secure the cooling fan bracket to the bottom of the workstation.

Step 14: Reinstall the two external retention screws that secure the cooling fan bracket to the left side panel of the workstation.

Step 15: Reinstall and reconnect all CPU cards and PCI/ISA expansion cards.

Step 16: Reinstall the dual CPU card clamp and drive bay stabilizer bracket. (See **Section 4.5.3**)

Step 17: Reinstall the CPU card clamp. (See **Section 4.5.2**)

RPC-6010G Rackmount LCD Workstation

Step 18: Reinstall the top cover of the workstation.

Step 19: Reinstall the workstation into the rack. Refer to **Section 4.6** for complete mounting instructions.

5.7 Disk Drive Replacement

5.7.1 3.5" Disk Drive Replacement

To replace a 3.5" disk drive, please follow the instructions below.

Step 1: Turn off and disconnect the workstation from all power sources.

Step 2: Remove the workstation from the rack in which it is installed.

Step 3: Open the top cover of the RPC-6010G rackmount workstation.
(See **Section 4.5.1**)

Step 4: Remove the CPU card clamp. (See **Section 4.5.2**)

Step 5: Remove the dual CPU card clamp and drive bay stabilizer bracket. (See **Section 4.5.3**)

Step 6: Disconnect all cabling from every hard drive.

Step 7: Remove the drive bracket (see **Section 4.5.4**).

Step 8: Remove the retention screws that secure the 3.5" disk drive to the drive bracket and slide the drive out of the bracket.

Step 9: Install the new 3.5" disk drive. (See **Section 4.5.6.3**)

Step 10: Reinstall the drive bracket to the workstation. (See **Section 4.5.7**)

Step 11: Reconnect all disk drive cabling.

Step 12: Close the top cover of the workstation and reinstall the workstation into the cabinet or rack in which it was previously installed. Refer to **Section 4.6** for complete mounting instructions.

5.7.2 5.25" Disk Drive Replacement

To replace a 5.25" disk drive, please follow the instructions below.



NOTE:

These instructions are also applicable for replacement of a 3.5" disk drive mounted in a 5.25" disk drive adapter bracket. Refer to **Section 4.5.6.2** for instructions on installing a 3.5" disk drive into a 5.25" drive bay slot.

- Step 1:** Turn off and disconnect the workstation from all power sources.
- Step 2:** Remove the workstation from the rack in which it is installed.
- Step 3:** Open the top cover of the RPC-6010G rackmount workstation.
(See **Section 4.5.1**)
- Step 4:** Remove the CPU card clamp. (See **Section 4.5.2**)
- Step 5:** Remove the dual CPU card clamp and drive bay stabilizer bracket. (See **Section 4.5.3**)
- Step 6:** Disconnect all cabling from every hard drive.
- Step 7:** Remove the drive bracket (see **Section 4.5.4**).
- Step 8:** Remove the retention screws that secure the 5.25" disk drive to the drive bracket and slide the drive out of the bracket.
- Step 9:** Install the new 5.25" disk drive. (See **Section 4.5.6.3**)
- Step 10:** Reinstall the drive bracket to the workstation. (See **Section 4.5.7**)
- Step 11:** Reconnect all disk drive cabling.
- Step 12:** Close the top cover of the workstation and reinstall the workstation into the cabinet or rack in which it was previously installed. Refer to **Section 4.6** for complete mounting instructions.

Chapter

6

On Screen Display (OSD) Controls

6.1 User Mode OSD Structure

6.1.1 OSD Buttons

There are several on-screen-display (OSD) control buttons on the front panel of the workstation. **Figure 6-1** shows a typical arrangement of OSD controls.



Figure 6-1: OSD Control Buttons



NOTE:

Pressing the direction keys (LEFT or RIGHT) can bring out a simple menu that adjusts the LCD screen brightness and contrast values.

RPC-6010G Rackmount LCD Workstation

6.1.2 OSD Menu Structure

Table 6-1 shows the OSD menu structure.

Level 0	Level 1	Value
Main Display Features Menu	Brightness	0 to 100
	Contrast	0 to 100
	Horizontal Size	0 to 100
	Phase	0 to 100
	H. Position	0 to 100
	V. Position	0 to 100
	Sharpness	1 to 5
Speaker	Volume	This menu is currently disabled, and will be implemented with models equipped with speakers.
	Mute	
Color Menu	9300	- Preset NTSC value
	7500	- Preset NTSC value
	User	RGB values from 0 to 100
Language Menu	English	Select
	French	
	German	
	Spanish	
	Italian	
	Japanese	
	Russian	
	Traditional Chinese	
Simplified Chinese		
OSD Menu	OSD Time Out	0 to 60 sec
	OSD Position	1 to 5
	OSD Transparency	0 to 100
	Auto Setting	On or Off
	Recall	No or Yes
	Aspect Ratio	4:3 or 5:4

Level 0	Level 1	Value
Signal Menu	Digital	Select
	Analog	
Backlight Menu	Light Enable	On or Off
	Light Contrast	0 to 100
	Light Brightness	0 to 100
	Light H Start	0 to 100
	Light H Width	0 to 100
	Light V Start	0 to 100
	Light V Height	0 to 100

Table 6-1: OSD Menus

6.2 Using the OSD

OSD menu options are described below.

6.2.1 Main Display Features

Main display features are shown in **Figure 6-2**.

Figure 6-2: Main Display Features

RPC-6010G Rackmount LCD Workstation

- **Brightness:**

The brightness option adjusts the brightness of screen. This function adjusts the offset value of ADC. Setting this value too high or too low will affect the quality of image.
- **Contrast:**

This function adjusts the gain value of ADC. Adjusting this value too high or too low will worsen the quality of image.
- **Horizontal Size:**

This item adjusts the screen size in the horizontal direction.
- **Phase:**

This option adjusts the input signal and dot clock position (Analog only).
- **H. Position:**

Adjusts the horizontal position of the display screen.
- **V. Position:**

Adjusts the vertical position of the display screen.
- **Sharpness:**

Adjusts the sharpness level to one of the 5 preset values. This option may help reducing the softening edges around displayed objects.

6.2.2 Color

Color options are shown in **Figure 6-3**.



Figure 6-3: Color Options

The Color menu fine-tunes the palette of color hues for the LCD.

- **9300:**
NTSC standard Kelvin
- **7500:**
NTSC standard Kelvin
- **6500:**
NTSC standard Kelvin
- **User:**
This item allows fine-tuning the balance among Red, Green, and Blue color hues if images look garish or unrealistic.

RPC-6010G Rackmount LCD Workstation

6.2.3 Language

The Languages are shown in **Figure 6-4**.



Figure 6-4: Language Menu

This menu provides options for selecting ODS screen legends in a preferred language.

6.2.4 OSD Configurations

The OSD configurations are shown in **Figure 6-5**.



Figure 6-5: OSD Configurations Menu

OSD Configurations are described below.

- **OSD Time Out:**
 Determines how many seconds the OSD screen stays on screen before it disappears when OSD is left unattended.
- **OSD Position:**
 Adjusts the OSD position on the screen. Position 1 is in the upper left of the screen, position 2 in the upper right and position 3 in the center.
- **OSD Transparency**
 Determines the opacity of OSD background.
- **Auto Setting**
 This function automatically adjusts the LCD screen position in situations such as connecting the LCD to a different host computer.
- **Recall**
 Restores the default OSD settings. Note that this will restore all default display settings.

RPC-6010G Rackmount LCD Workstation

■ Aspect Ratio

Adjusts the display ratio referring to the width of the screen and then to the height of the screen.

6.2.5 Signal

The Signal menu in **Figure 6-6** enables manual selection of the type of graphic source input, i.e., analog (15-pin VGA) or digital (DVI-D).



Figure 6-6: Signal Menu

6.2.6 Backlight

The Backlight menu in **Figure 6-7** enables users to configure the LCD backlight.



Figure 6-7: Backlight Menu

Backlight Menu options are described below.

- **Light Enabled:**
 Turns backlight on or off.
- **Light Contrast:**
 Adjusts the backlight contrast.
- **Light Brightness:**
 Adjusts the backlight brightness.
- **Light H Start:**
 Adjusts the backlight projection area in the horizontal direction.
- **Light H Width:**
 Adjusts the width of the backlight projection area.
- **Light V Start:**
 Adjusts the backlight projection area in the vertical direction.
- **Light V Height:**
 Adjusts the height of the backlight projection area.

Chapter

7

Software Driver

**NOTE:**

The following information is provided for workstations with touch screens.

7.1 Touch Screen Driver

The touch screen controller enables analog resistive touch screens for four-wire, five-wire & eight-wire models. The controller directly communicates with the PC system through the touch screen communications interface. The controller design is superior in sensitivity, accuracy, and friendly operation. The touch screen driver emulates the left mouse button and the right mouse button functions.

The touch screen driver supports the following operating systems:

- Microsoft Windows versions:
 - Microsoft Windows 95
 - Microsoft Windows 98
 - Microsoft Windows ME
 - Microsoft Windows 2000
 - Microsoft Windows NT
 - Microsoft Windows XP
 - Microsoft Windows XP Tablet PC Edition
- Microsoft Windows CE versions:
 - Microsoft Windows CE 2.12
 - Microsoft Windows CE 3.0
 - Microsoft Windows CE. NET
- Linux
- IMac
- DOS.

Driver installation is described below.

7.2 Driver Installation

To install the touch screen software driver, please follow the steps below.

Step 1: Insert the TouchKit driver CD that came with the RPC-6010G rackmount workstation into the CD drive.

Step 2: Once the CD drive is installed, the screen in **Figure 7-1** appears.

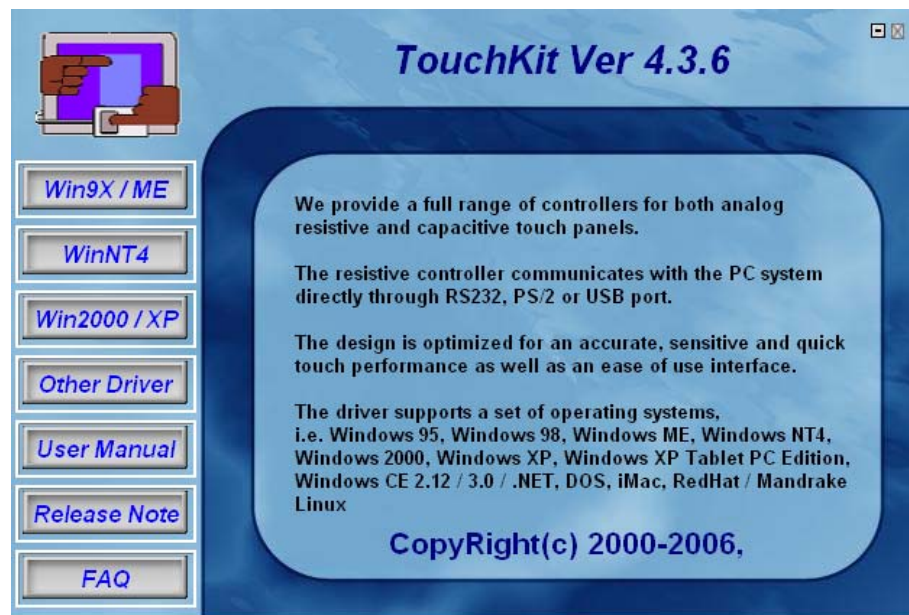

Figure 7-1: Driver CD Pop Up Screen

Step 3: Select the operating system installed on the system from the menu on the left side of the screen.



NOTE:

The following description is for driver installation using a Windows 2000 OS. If a different OS is installed, please refer to the driver user manual for the relevant OS. The driver user manuals can be accessed by selecting “**User Manual**” from the menu on the left side of the “**Driver CD Pop Up Screen**”.

Step 4: Once the OS system is selected, the touch kit setup will prepare the install shield wizard (**Figure 7-2**).

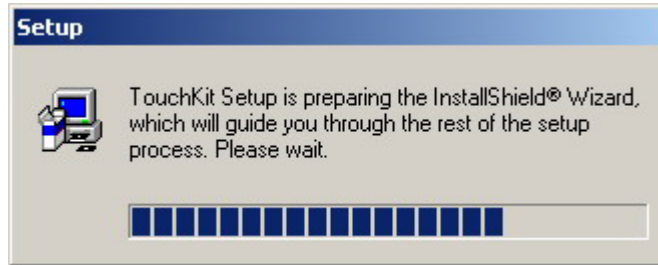

Figure 7-2: Install Shield Wizard Preparation

Step 5: After the Install Shield Wizard is ready, a welcome screen appears (**Figure 7-3**).

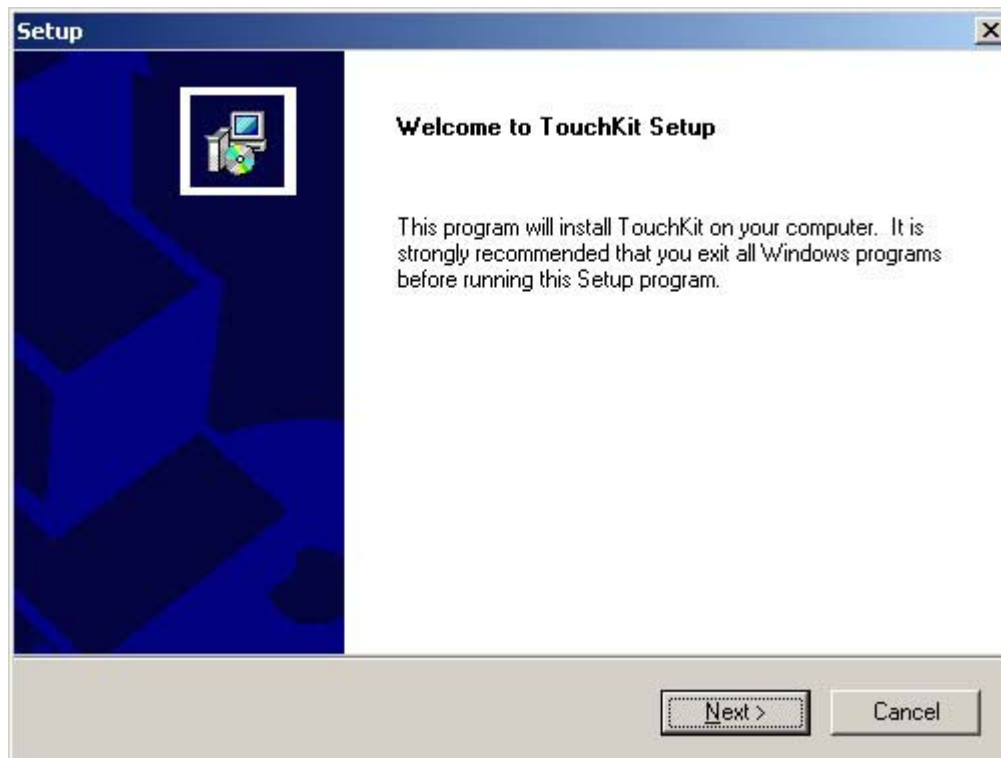

Figure 7-3: Welcome Screen

Step 6: To continue the installation process click **NEXT**.

RPC-6010G Rackmount LCD Workstation

Step 7: An Install PS/2 interface driver screen appears (**Figure 7-4**). It is not necessary to install the PS/2 interface driver. To continue click **NEXT**.

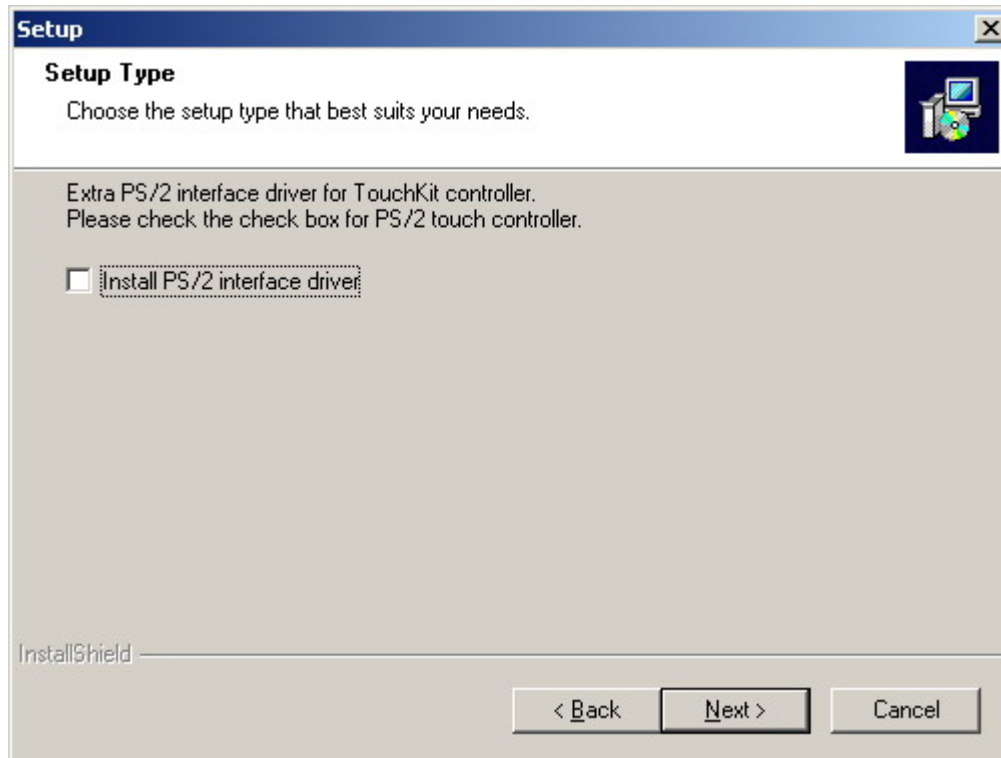

Figure 7-4: Install PS/2 Interface Driver

Step 8: Four point calibration options are then selected (**Figure 7-5**). Four point calibrations can be done every time a user boots up, during the next time the system boots or never. Select if and when a four-point calibration should be done. Click **NEXT** to continue.

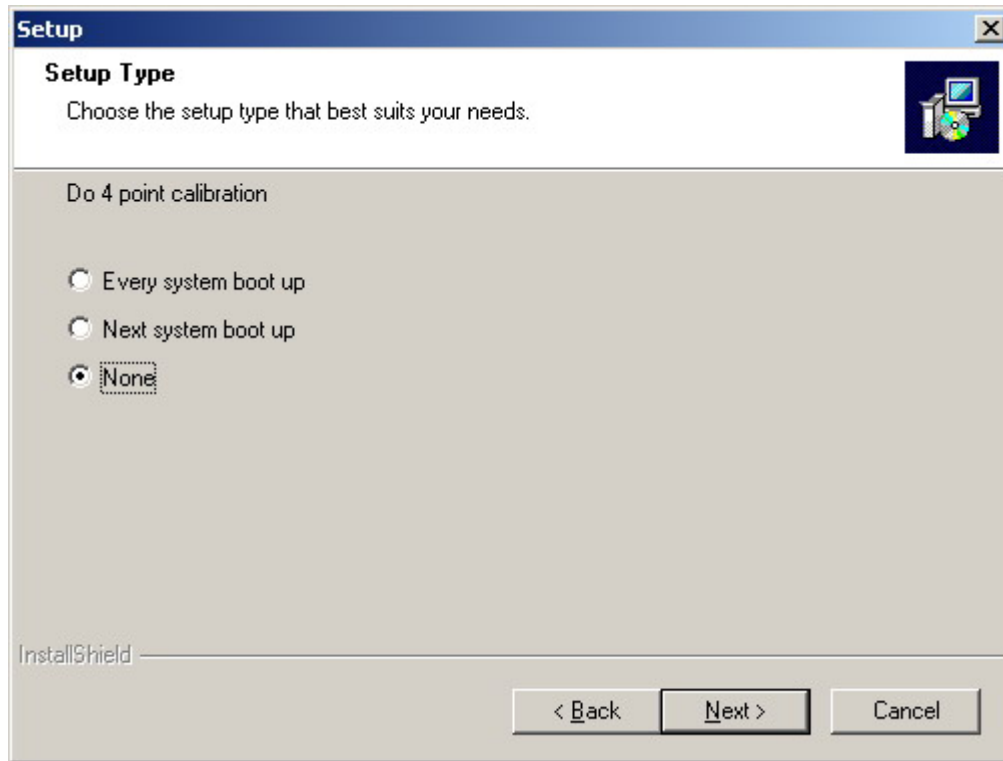

Figure 7-5: Install PS/2 Interface Driver

Step 9: The user is then prompted to ensure the touch monitor or the USB for the touch controller is plugged into the system (**Figure 7-6**). Once the touch controller is plugged into the system, click “OK.”



Figure 7-6: Touch Monitor/USB Touch Controller Confirmation

RPC-6010G Rackmount LCD Workstation

Step 10: The user is then prompted to select multi-monitor system support (Figure 6-7).

Make the appropriate selection and click **NEXT** to continue.

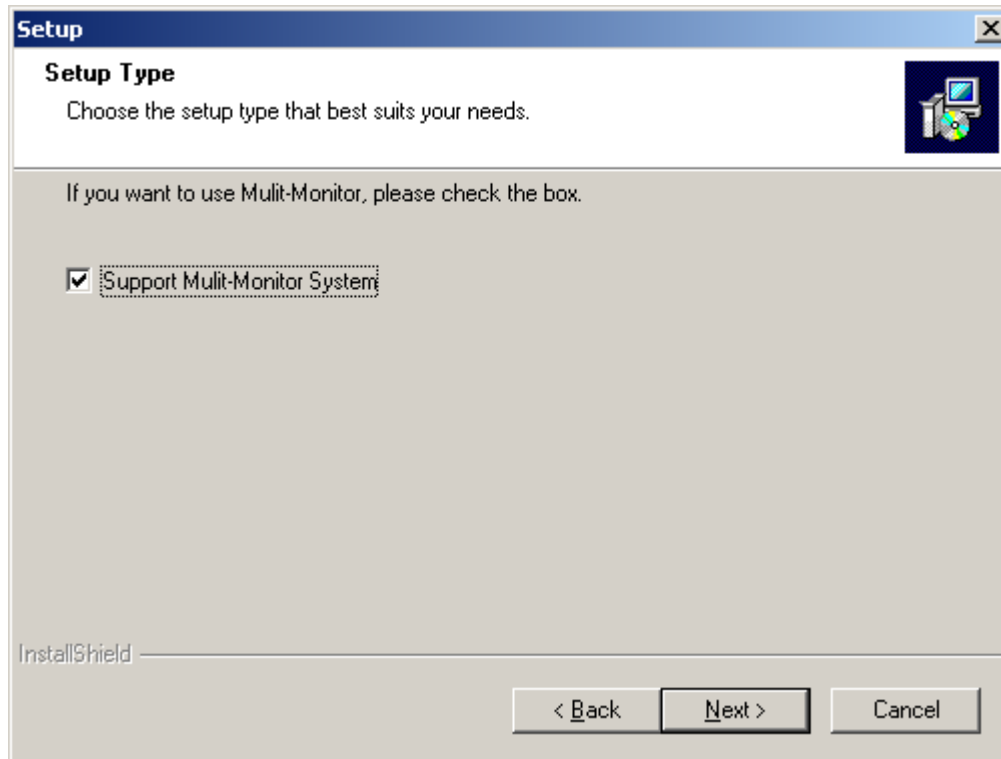

Figure 7-7: Controller Installation Directory

Step 11: The user is then prompted to select a file directory in which the touch kit controller is installed (**Figure 7-8**). The default directory is “C:\Program Files\TouchKit.” If a different folder must be used, select browse and then select the folder. Once the folder is selected, click **NEXT** to continue.

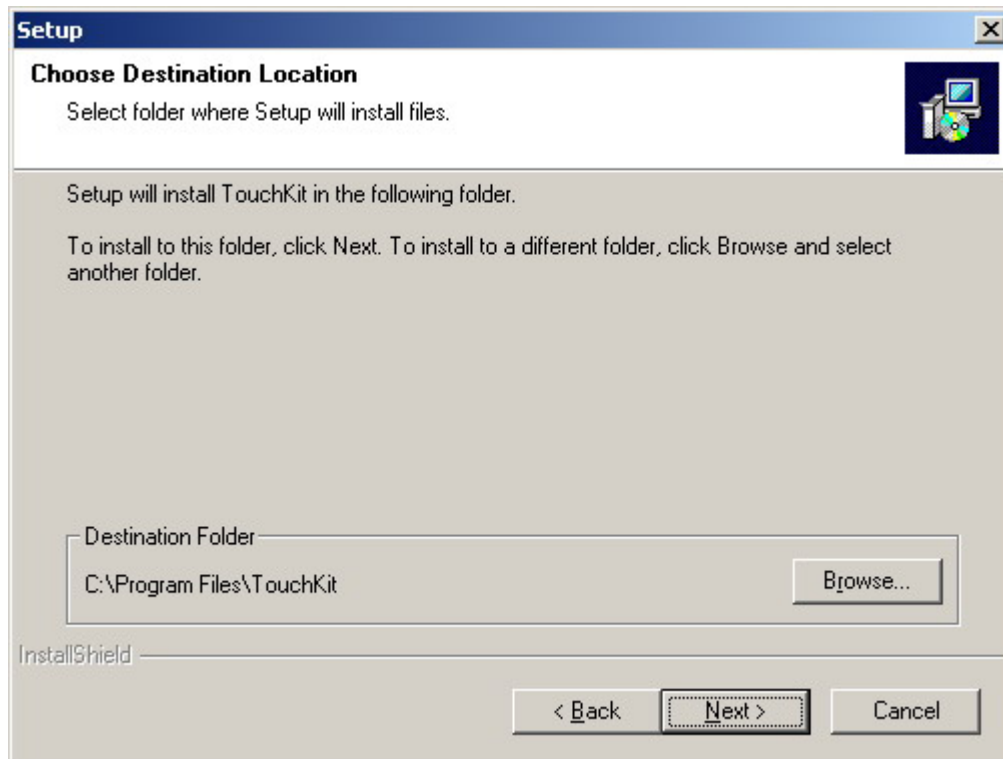

Figure 7-8: Controller Installation Directory

RPC-6010G Rackmount LCD Workstation

Step 12: The user is then prompted to select a file directory in which the program icons are saved (**Figure 7-9**). The default folder is “TouchKit.” If a different folder must be used, select a folder from the list shown. Once the folder is selected, click **NEXT** to continue.

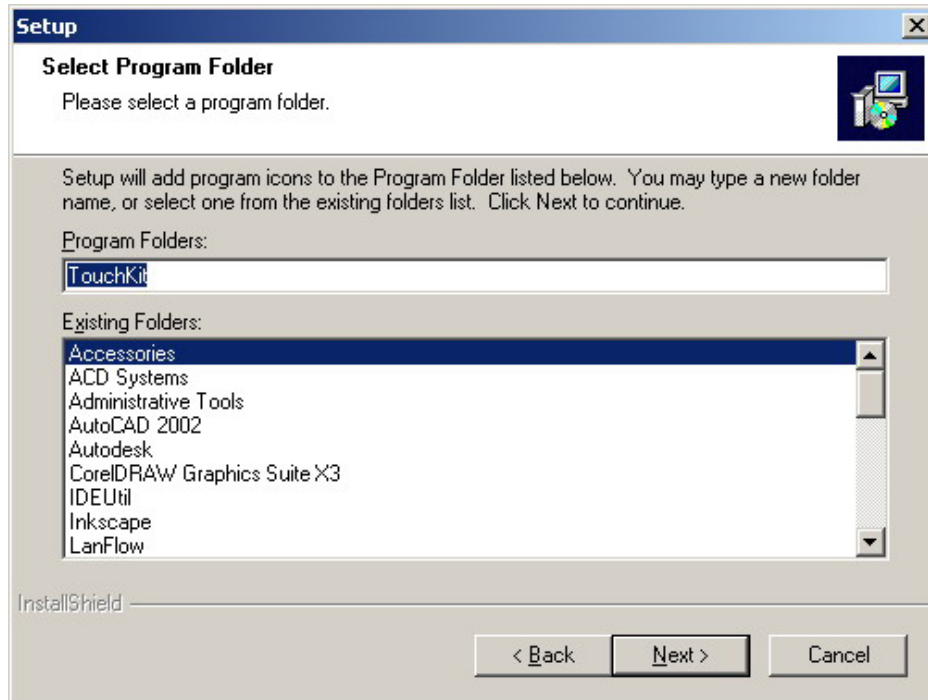

Figure 7-9: Program Icon Directory

Step 13: The program then starts installing (Figure 7-10).

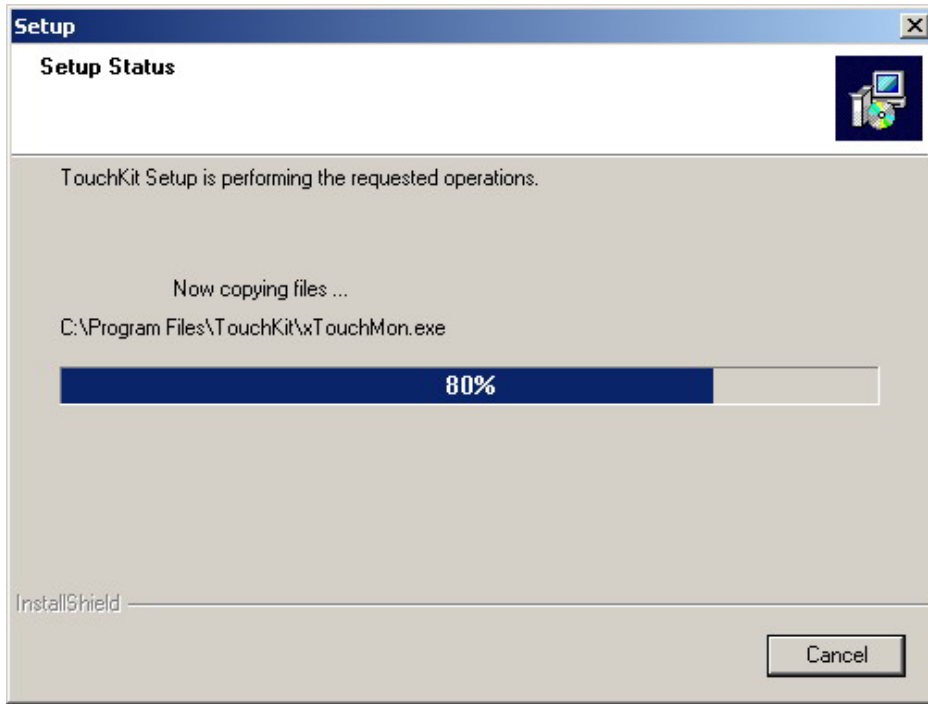

Figure 7-10: Installing

RPC-6010G Rackmount LCD Workstation

Step 14: Once the program is finished installing, the user is prompted to restart the computer now or to restart the computer later (**Figure 7-11**). Select when the computer should be restarted and click “**FINISH**” to complete the driver installation procedure.



Figure 7-11: Installation Complete

7.3 Touch Screen Driver Configuration

To configure the touch screen driver options, refer to the TouchKit user manual located on the driver installation CD.



THIS PAGE IS INTENTIONALLY LEFT BLANK

Appendix

A

Certifications



A.1 RoHS Compliant

All RPC-6010G rackmount workstations comply with the Restriction of Hazardous Materials (RoHS) Directive. This means that all components used to build the industrial workstations and the workstation itself are RoHS compliant.

The RoHS Directive bans the placing on the EU market of new electrical and electronic equipment containing more than agreed levels of lead, cadmium, mercury, hexavalent chromium, polybrominated biphenyl (PBB) and polybrominated diphenyl ether (PBDE) flame retardants.

Appendix

B

Recommended IEI Backplanes, Motherboards and PSUs

The following IEI backplanes, motherboards and power supply units are recommended for the RPC-6010G rackmount workstation. For more information about these backplanes please contact an IEI sales representative or visit the IEI website (www.ieiworld.com).

B.1 Recommended IEI Backplanes and Motherboards

The following table lists the recommended IEI backplanes and motherboards for the RPC-6010G rackmount workstation.

Model No.	SBC Type	PCI	ISA	PCIe			PSU Connector
				X1	X4	X16	
PCI-13SD-RS-R30	PICMG 1.0	3 + 4	3 + 3	0	0	0	AT/ATX
PCI-14S2-RS-R30	PICMG 1.0	4	8	0	0	0	AT/ATX
PCI-14S3-RS-R30	PICMG 1.0	4	9	0	0	0	AT/ATX
PX-14S3-RS-R30	PICMG 1.0	12	2	0	0	0	AT/ATX
PX-14S5-RS-R30	PICMG 1.0	7	6	0	0	0	AT/ATX
BP-14S-RS-R30	ISA	0	14	0	0	0	AT
PXAGP-13S3-RS-R30	PIAGP	11	0	0	0	0	AT/ATX
PE-13SD	PICMG 1.3	4	0	5	0	2	ATX
PXE-13S	PICMG 1.3	8	0	3	0	1	ATX
PXE-13S2	PICMG 1.3	4	0	7	0	1	ATX
PXE-13S3	PICMG 1.3	3	0	0	8	1	ATX

Table B-1: Recommended IEI Backplanes and Motherboards

B.2 Recommended IEI Power Supply Units

The following table lists the recommended IEI power supply units for the RPC-6010G rackmount workstation.

Type	Model No.	Watt
AT	ACE-935AL-RS	300W
	ACE-940AP-RS	390W
ATX	ACE-832AP-RS	250W
	ACE-841AP-RS	480W
	ACE-850AP-RS	500W
Redundant ATX	ACE-R4130AP-RS	300W
	ACE-R4140AP-RS	400W

Table B-2: Recommended IEI Power Supply Units



THIS PAGE IS INTENTIONALLY LEFT BLANK

Index

A

ACE-832AP PSU Specifications 16
 Active Area 15

B

Backlight 15
 Brightness 15

C

Certifications 81
 Contrast Ratio 15

D

Driver 69
 Drivers
 Touch Screen 70

F

Features 2

I

Input Current 16
 Inrush Current 16
 Installation 17
 3.5 inch Disk Drive 31
 3.5 inch Disk Drive in a 5.25 inch Slot... 30
 5.25 inch Disk Drive 29
 Backplane 33
 Connect the Cables 39
 CPU Card 35

Installation Steps 23
 PCI/ISA Expansion Card 37
 Precautions 18
 Preinstalled Components 23
 Prerequisites 18
 Remove the CPU Card Clamp 26
 Remove the Drive Bracket 28
 Remove the Drive Slot Blank Plate 28
 Remove the Dual CPU Card Clamp &
 Drive Bay Stabilizer Bracket 26
 Remove the Top Cover 25
 User Installed Components 23

L

LCD Specifications 15

M

Maintenance 47
 Backplane Replacement 50
 Cooling Fan Replacement 54
 CPU Card Replacement 48
 Disk Drive Replacement 57
 PCI/ISA Expansion Card Replacement 49
 PSU Replacement 51
 Mechanical Overview 5
 14-Slot Rear Panel 7
 ATX Motherboard Rear Panel 8
 Dimensions 10
 Front Panel 6
 Left Side Panel 10
 Right Side Panel 9
 Model Variations 2
 Mounting 40

RPC-6010G Rackmount LCD Workstation

N

Number of Colors..... 15

O

On Screen Display (OSD) 59

P

Packing List iv, 20

Pixel Pitch 15

R

Recommended IEI Backplanes and

 Motherboards 84

Recommended IEI Power Supply Units 85

Resolution 15

Response Time 15

S

Shock 14

Specifications 14

T

Touch Screen Driver 70

Touch Screen Driver Configuration 79

U

Unpacking 19

V

Vibration 14

View Angle 15

Voltage 16