



tDS-712(i)



tDS-700 Series



tDS-700-T Series



tDSM-712

Tiny Serial-to-Ethernet Device Server

Features

- Incorporates any RS-232/422/485 serial device in Ethernet
- Application Modes: Virtual COM, TCP Server, TCP Client
- VxComm Utility supports 32/64-bit Windows 7 SP1/10/2012/2016
- Max. connections : 1 socket per serial port is suggested
- Supports pair-connection (serial-bridge, serial-tunnel) applications
- Supports UDP responder for device discovery (UDP Search)
- Tiny Web server for configuration (HTTP)
- Contains a 32-bit MCU that efficiently handles network traffic
- Allows automatic RS-485 direction control
- Power or Signal isolation for i versions



Introduction

The tDS-700 is a series of Serial-to-Ethernet device servers designed to add Ethernet and Internet connectivity to any RS-232 and RS-422/485 device, and to eliminate the cable length limitation of legacy serial communication. By using the VxComm Driver/Utility, the built-in COM port of the tDS-700 series can be virtualized to a standard PC COM port in Windows. Therefore, users can transparently access or monitor serial devices over the Internet/Ethernet without software modification. **Note: For multiple TCP connections on the same serial port, use PDS-700 instead.**

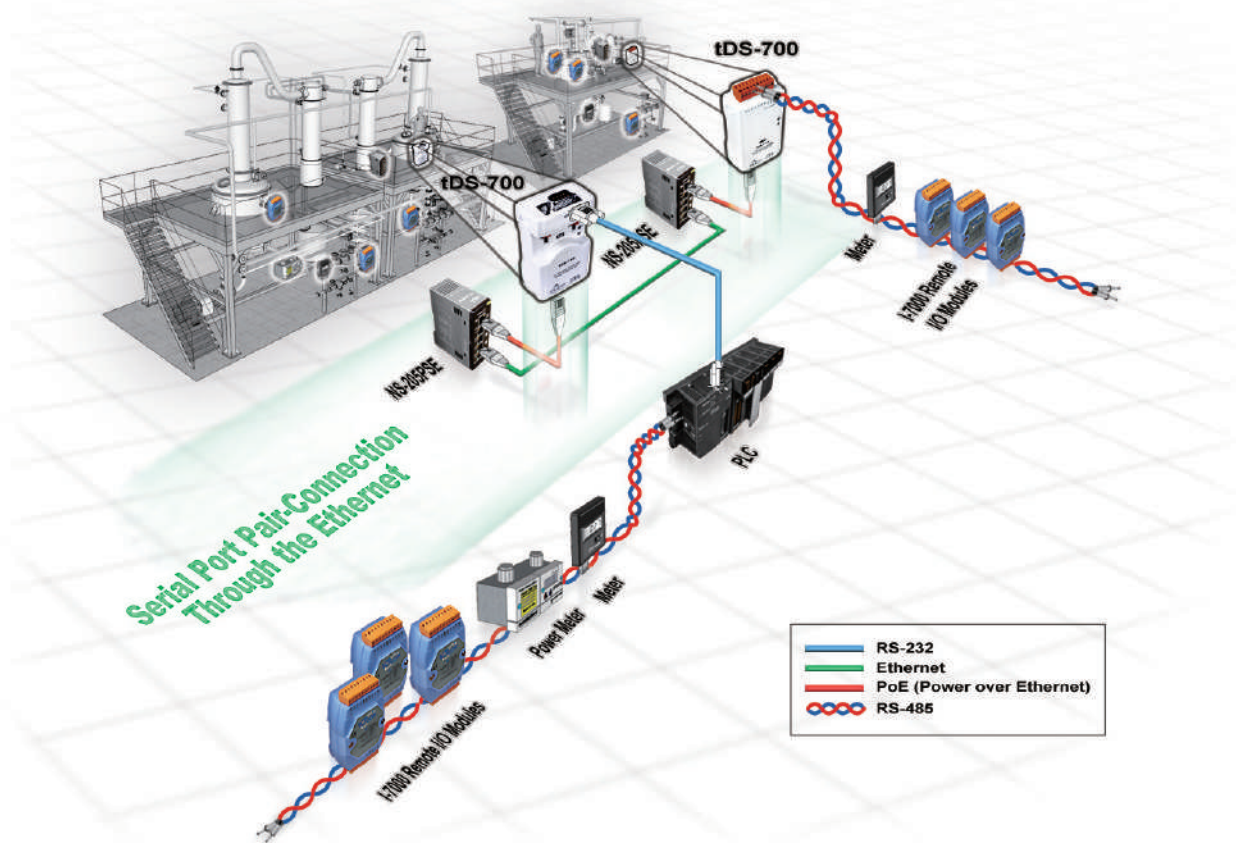

The VxComm Driver/Utility supports the most popular operating system in the world, including 32/64-bit Windows 7 SP1/10/2012/2016. **The virtual COM works transparently and is protocol independent, enabling perfect integration with your current central computer.** The utility provides an easy configuration interface that can be used to quickly create and map virtual COM ports to one or several tDS-700 modules. In addition, the utility contains a built-in terminal program, so users can send/receive command/data via the terminal program for easy testing.

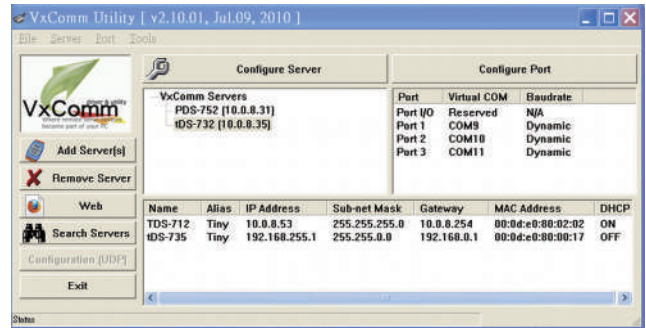

The tDS-700 device servers can be used to create a pair-connection application (as well as serial-bridge or serialtunnel), and can then route data over TCP/IP between two serial devices, which is useful when connecting mainframe computers, servers or other serial devices that do not themselves have Ethernet capability. By virtue of its protocol independence and flexibility, the tDS-700 meets the demands of virtually any network-enabled application.

The tDS-700 features a powerful 32-bit MCU to enable efficient handling of network traffic. It also has a built-in web server that provides an intuitive web management interface to allow users to modify the settings of the module, including DHCP/Static IP, gateway/mask and serial ports.

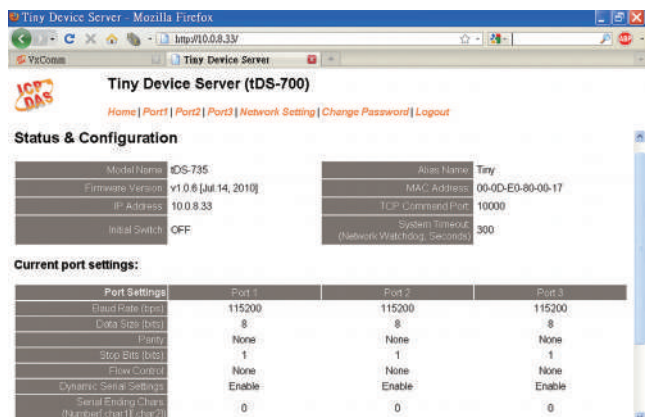

Based on an amazing tiny form-factor, the tDS-700 achieves the maximum space savings that allows it to be easily installed anywhere, even directly attached to a serial device or embedded into a machine.

The tDS-700 series also contains a built-in CPU watchdog, which automatically resets the CPU if the builtin firmware is operating abnormally, or if there is no communication between the tDS-700 and the host for a predefined period of time (system timeout). This is an important feature that ensures the tDS operates continuously, even in harsh environments.



The tDS-700(non-T) offers true IEEE 802.3af-compliant (classification, Class 1) Power over Ethernet (PoE) functionality using a standard category 5 Ethernet cable to receive power from a PoE switch such as the NS-205PSE. If there is no PoE switch on site, the tDS-700 will also accept power input from a DC adapter. The tDS-700 is designed for ultra-low power consumption, reducing hidden costs from increasing fuel and electricity prices, especially when you have a huge amount of device servers installed. Reducing the amount of electricity consumed by choosing energy-efficient equipment can have a positive impact on maintaining a green environment.

The tDS-712 is equipped with a male DB-9 connector, while other models are equipped with a removable terminal block connector to allow easy wiring, and also supports automatic RS-485 direction control when sending and receiving data.

Applications

- Factory Automation
- Building Automation
- Home Automation
- Remote Diagnosis and Management



Comparison Table	tDS-700 Series	tDS-700-T Series	PDS-700 Series
Ethernet	10/100 M, PoE	10/100 M	10/100 M
Programmable	–	–	Yes
Virtual COM	Yes	Yes	Yes
Virtual I/O	–	–	Yes
DHCP	Yes	Yes	Yes
Web Configuration	Yes	Yes	Yes
UDP Search	Yes	Yes	Yes
Multi-client	–	–	Yes
Remarks	Cost-effective	Cost-effective	–

1. Access serial device via Virtual COM ports

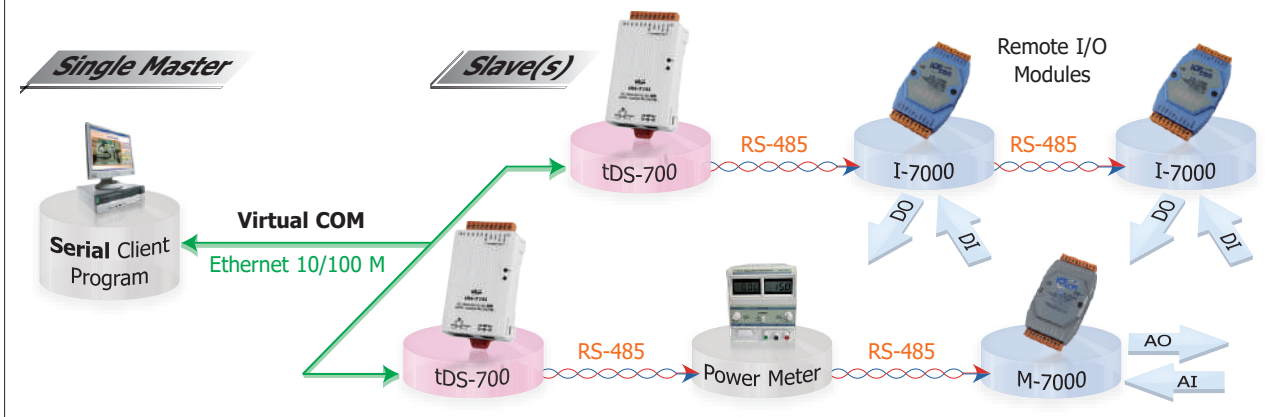

2. Access serial device via TCP/IP socket connection

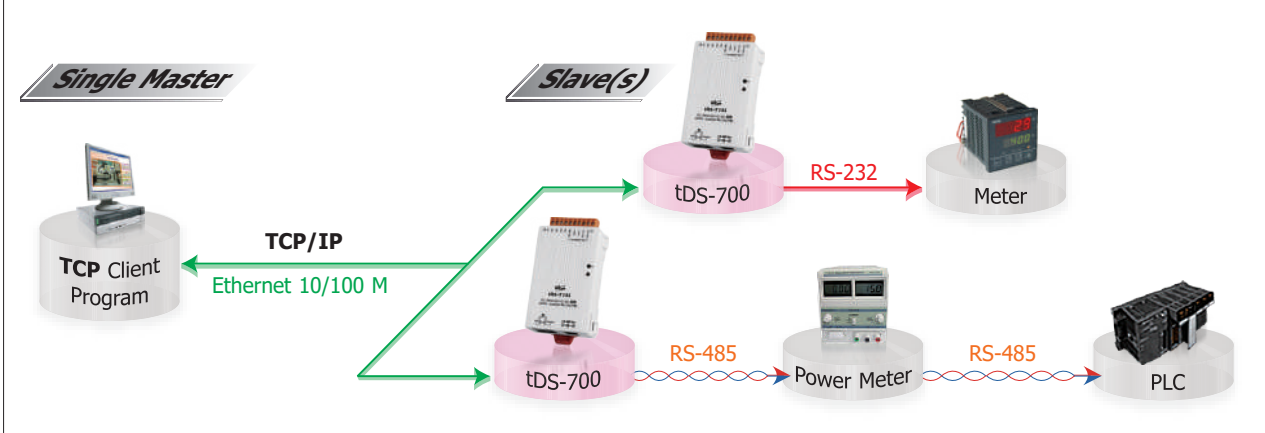

3. Virtual RS-485 bus application through pair-connection

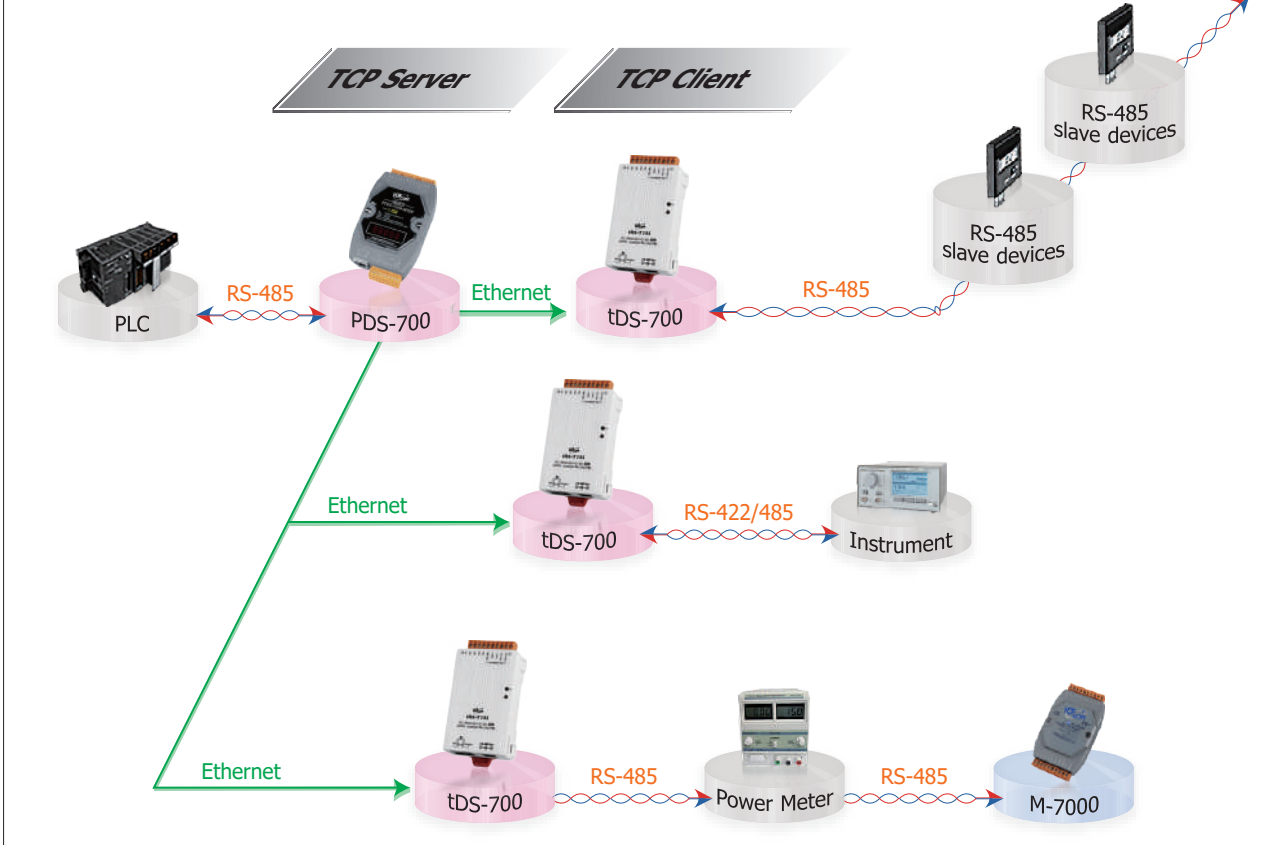





Specifications

Models	tDS-712 tDS-712i tDSM-712	tDS-722 tDS-722i	tDS-732 tDS-732i	tDS-715 tDS-715i tDS-715-T tDS-715i-T	tDS-725 tDS-725i	tDS-735 tDS-735i	tDS-718 tDS-718i tDS-718-T tDS-718i-T	tDS-718i-D	tDS-724 tDS-724i	tDS-734 tDS-734i
System										
CPU	32-bit MCU									
Communication Interface										
Ethernet	10/100 Base-TX, 8-pin RJ-45 x 1, (Auto-negotiating, Auto-MDI/MDIX, LED indicator)									
PoE	700 Series	IEEE 802.3af, Class 1								
	700-T Series	-								
COM Port	1 x RS-232	2 x RS-232	3 x RS-232	1 x RS-422/ RS-485	2 x RS-485	3 x RS-485	1 x RS-232 or RS-422/485	1 x RS-485 1 x RS-232	1 x RS-485 2 x RS-232	
Self-Tuner	-			Yes, automatic RS-485 direction control						
Power Isolation	1000 Vdc for tDS-722i/ 732i/718i-D									
Signal Isolation	3000 Vdc for tDS-712i/ 715i/725i/735i/718i/724i/734i/715i-T/ 718i-T									
ESD Protection	+/-4 kV									
COM Port Capability (16C550 or compatible UART)										
Baud Rate	115200 bps Max.									
Data Bit	5, 6, 7, 8									
Parity	None, Odd, Even, Mark, Space									
Stop Bit	1, 2									
Power										
Power Input	IEEE 802.3af, Class 1 for PoE; +12 ~ 48 Vdc for DC Jack									
Power Consumption	0.07 A @ 24 Vdc									
Mechanical										
Connector	Male DB-9 x 1 for tDS-712(i)/ 718i-D 10-pin Removable Terminal Block x 1 for tDS-722(i)/ 732(i)/ 715(i)/ 725(i)/ 735(i)/ 718(i)/ 724(i)/ 734(i)/ 715(i)-T/ 718(i)-T									
Dimensions (W x L x H)	52 mm x 27 mm x 95 mm (tDS-712: 52 mm x 27 mm x 90 mm) (tDSM-712: 75 mm x 24 mm x 83 mm)									
Installation	DIN-Rail mounting									
Case	Metal for tDSM-712; Plastic for others.									
Environment										
Operating Temperature	-25 °C ~ +75 °C									
Storage Temperature	-30 °C ~ +80 °C									
Humidity	10 ~ 90% RH, non-condensing									

Note: COM1 = TCP Port 10001, COM2 = TCP Port 10002, COM3 = TCP Port 10003

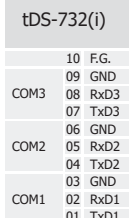
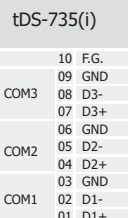
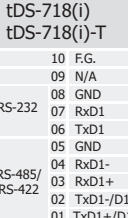
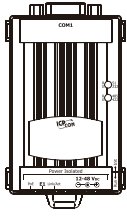
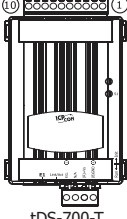
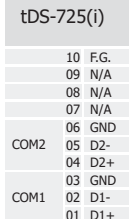
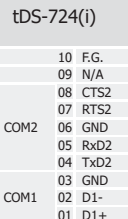
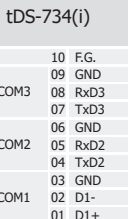
Apparances

	tDS-712(i) tDSM-712 09 N/A 08 CTS1 07 RTS1 06 N/A 05 GND 04 N/A 03 TxD1 02 RxD1 01 N/A COM1 (Male DB-9)		tDS-722(i) 10 F.G. 09 GND 08 RTS2 07 RxD2 06 TxD2 05 GND 04 CTS1 03 RTS1 02 RxD1 01 TxD1 COM2 COM1		tDS-732(i) 10 F.G. 09 GND 08 RxD3 07 TxD3 06 GND 05 RxD2 04 CTS1 03 GND 02 RxD1 01 TxD1 COM3 COM2 COM1		tDS-735(i) 10 F.G. 09 GND 08 D3- 07 D3+ 06 GND 05 D2- 04 D2+ 03 GND 02 D1- 01 D1+ COM3 COM2 COM1		tDS-718(i) tDS-718(i)-T 10 F.G. 09 N/A 08 GND 07 RxD1 06 TxD1 05 GND 04 RxD1- 03 RxD1+ 02 TxD1-/D1- 01 TxD1+/D1+ RS-232 RS-485/ RS-422		
	tDS-718i-D Terminal No. RS-232 RS-422 RS-485 09 N/A N/A N/A 08 CTS N/A N/A 07 RTS N/A N/A 06 N/A N/A N/A 05 GND GND GND 04 N/A RxD- N/A 03 TxD RxD+ N/A 02 RxD TxD+ Data+ 01 N/A TxD- Data- COM1 (Male DB-9)		tDS-715(i) tDS-715(i)-T 10 F.G. 09 N/A 08 N/A 07 N/A 06 N/A 05 GND 04 RxD1- 03 RxD1+ 02 TxD1-/D1- 01 TxD1+/D1+ RS-485/ RS-422 COM2 COM1		tDS-725(i) 10 F.G. 09 N/A 08 N/A 07 N/A 06 GND 05 D2- 04 D2+ 03 GND 02 D1- 01 D1+ COM2 COM1		tDS-724(i) 10 F.G. 09 N/A 08 CTS2 07 RTS2 06 GND 05 RxD2 04 TxD2 03 GND 02 D1- 01 D1+ COM2 COM1		tDS-734(i) 10 F.G. 09 GND 08 RxD3 07 TxD3 06 GND 05 RxD2 04 TxD2 03 GND 02 D1- 01 D1+ COM3 COM2 COM1		
			tDS-700-T Series								

■ Dimensions (Units: mm)

tDS-712/712i/718i-D

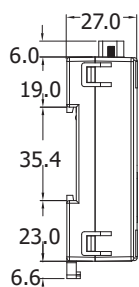

Left Side View

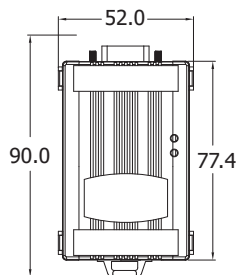

Front View

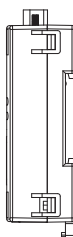

Right Side View

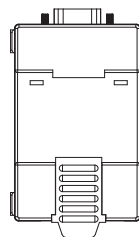

Rear View

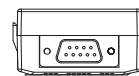

Top View

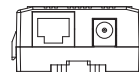

Bottom View

tDS-715(i)/718(i)/722(i)/725(i)/732(i)/735(i)/724(i)/734(i)

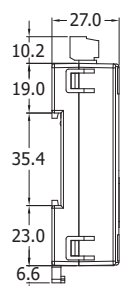

Left Side View

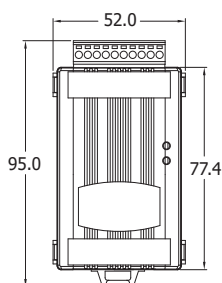

Front View

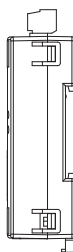

Right Side View

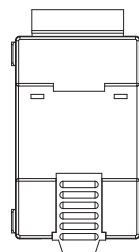

Rear View

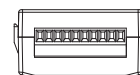

Top View

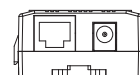

Bottom View

tDS-715(i)-T/718(i)-T

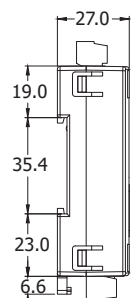

Left Side View

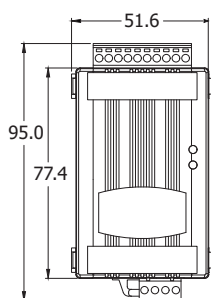

Front View

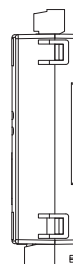

Right Side View

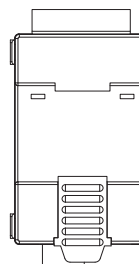

Rear View

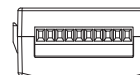

Top View



Bottom View

tDSM-712

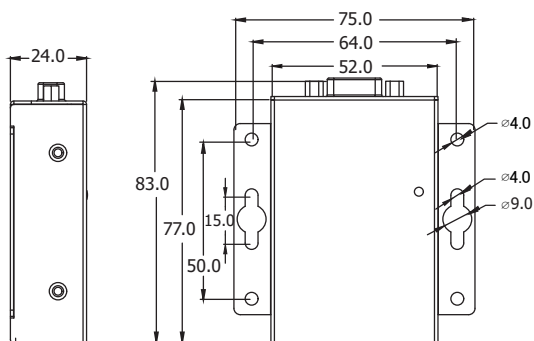

Left Side View

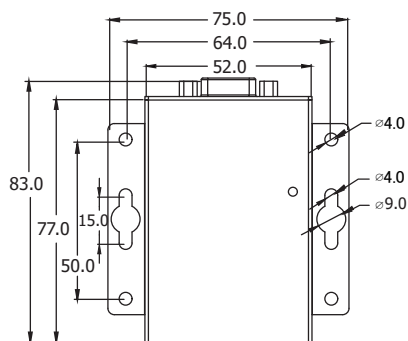

Front View

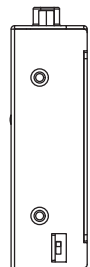

Right Side View

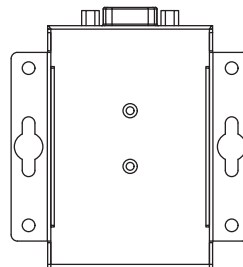

Rear View

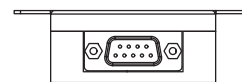

Top View

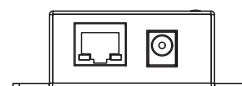

Bottom View

Ordering Information

Non-Isolated	Isolated	Tiny Device Server with PoE and DC Jack: Include one CA-002 cable
tDS-712 CR	tDS-712i CR	Tiny (1x RS-232) Serial-to-Ethernet Device Server with PoE (RoHS)
tDS-722 CR	tDS-722i CR	Tiny (2x RS-232) Serial-to-Ethernet Device Server with PoE (RoHS)
tDS-732 CR	tDS-732i CR	Tiny (3x RS-232) Serial-to-Ethernet Device Server with PoE (RoHS)
tDS-715 CR	tDS-715i CR	Tiny (1x RS-422/485) Serial-to-Ethernet Device Server with PoE (RoHS)
tDS-725 CR	tDS-725i CR	Tiny (2x RS-485) Serial-to-Ethernet Device Server with PoE (RoHS)
tDS-735 CR	tDS-735i CR	Tiny (3x RS-485) Serial-to-Ethernet Device Server with PoE (RoHS)
tDS-718 CR	tDS-718i CR tDS-718i-D CR	Tiny (1x RS-232/422/485) Serial-to-Ethernet Device Server with PoE (RoHS) (10-pin Terminal Block Connector for tDS-718/718i, Male DB-9 Connector for tDS-718i-D)
tDS-724 CR	tDS-724i CR	Tiny (1x RS-232 and 1x RS-485) Serial-to-Ethernet Device Server with PoE (RoHS)
tDS-734 CR	tDS-734i CR	Tiny (2x RS-232 and 1x RS-485) Serial-to-Ethernet Device Server with PoE (RoHS)
tDSM-712 CR	-	Tiny (1x RS-232) Serial-to-Ethernet Device Server with PoE (Metal case, RoHS)

Non-Isolated	Isolated	Tiny Device Server with DC Terminal Block
tDS-715-T CR	tDS-715i-T CR	Tiny (1x RS-422/485) Serial-to-Ethernet Device Server (RoHS)
tDS-718-T CR	tDS-718i-T CR	Tiny (1x RS-232/422/485) Serial-to-Ethernet Device Server (RoHS)

Accessories

CA-002

DC jack to 2-wire Power Cable, 30 cm (RoHS)



CA-0915

DB9 Male to DB9 Female Cable [RS-232: Pin1-Pin9], 1.5 M (RoHS)



CA-0910F

DB9 Female to DB9 Female Cable [RS-232: Pin1-Pin9], 1 M (RoHS)



CA-0910N

DB9 Female to DB9 Female crossover Cable [RS-232: Pin2, Pin3 and Pin5], 1 M (RoHS)



CA-PC09F

DB9 connector Female with plastic cover (Solder Type) (RoHS)



UP0061D-12PA58G CR

Wall mount power supply; Input range 90~240 VAC; Output 12 Vdc/0.5 A, 6 W; two pins USA plug (RoHS)



NS-205PSE CR

Unmanaged 5-port 10/100 Mbps PoE (PSE) Ethernet Switch (RoHS)



NS-205PSE-24V CR

Unmanaged 5-port 10/100 Mbps PoE (PSE) Ethernet Switch; 24 Vdc Input (RoHS)

