

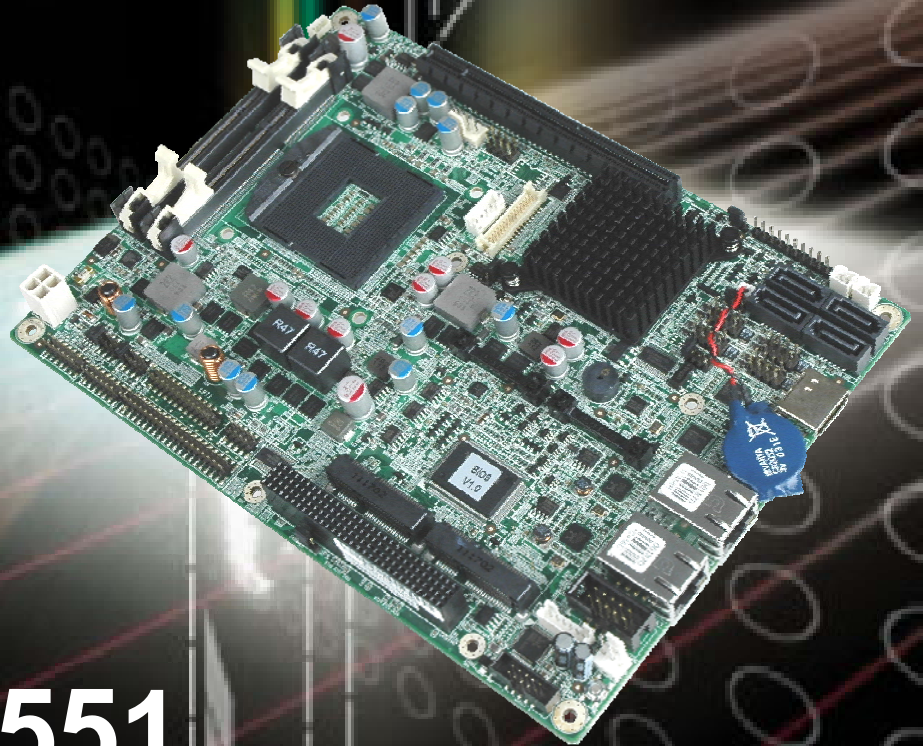

IEI Technology Corp.



**MODEL:  
NOVA-HM551**

**5.25" Motherboard Supports Socket G1 Intel® Core™ i3/i5/i7 CPU, VGA/HDMI/LVDS Dual Display, Dual GbE, Eight USB 2.0, Four SATA 3Gb/s, Two PCIe mini, PCIe x16, PCI-104, RoHS**

## User Manual

Rev. 1.10 - 30 August, 2011



# Revision

---

Date	Version	Changes
30 August, 2011	1.10	Updated for R11 version
8 February, 2011	1.00	Initial release

# Copyright

---

## **COPYRIGHT NOTICE**

The information in this document is subject to change without prior notice in order to improve reliability, design and function and does not represent a commitment on the part of the manufacturer.

In no event will the manufacturer be liable for direct, indirect, special, incidental, or consequential damages arising out of the use or inability to use the product or documentation, even if advised of the possibility of such damages.

This document contains proprietary information protected by copyright. All rights are reserved. No part of this manual may be reproduced by any mechanical, electronic, or other means in any form without prior written permission of the manufacturer.

## **TRADEMARKS**

All registered trademarks and product names mentioned herein are used for identification purposes only and may be trademarks and/or registered trademarks of their respective owners.

# Table of Contents

---

<b>1 INTRODUCTION</b> .....	<b>1</b>
1.1 INTRODUCTION.....	2
1.2 CONNECTORS .....	3
1.3 DIMENSIONS.....	4
1.4 DATA FLOW .....	6
1.5 TECHNICAL SPECIFICATIONS .....	7
<b>2 UNPACKING</b> .....	<b>9</b>
2.1 ANTI-STATIC PRECAUTIONS .....	10
2.2 UNPACKING PRECAUTIONS.....	10
2.3 PACKING LIST.....	11
2.3.1 <i>Optional Items</i> .....	12
<b>3 CONNECTORS</b> .....	<b>14</b>
3.1 PERIPHERAL INTERFACE CONNECTORS.....	15
3.1.1 <i>NOVA-HM551 Layout</i> .....	15
3.1.2 <i>Peripheral Interface Connectors</i> .....	16
3.1.3 <i>External Interface Panel Connectors</i> .....	17
3.2 INTERNAL PERIPHERAL CONNECTORS .....	18
3.2.1 <i>Audio Connector</i> .....	18
3.2.2 <i>Battery Connector</i> .....	19
3.2.3 <i>Digital I/O Connector</i> .....	19
3.2.4 <i>Fan Connector (CPU)</i> .....	20
3.2.5 <i>Fan Connector (System)</i> .....	21
3.2.6 <i>Front Panel Connector</i> .....	22
3.2.7 <i>Keyboard/Mouse Connector</i> .....	23
3.2.8 <i>Backlight Inverter Connector</i> .....	24
3.2.9 <i>LVDS LCD Connector</i> .....	25
3.2.10 <i>Parallel Port Connector</i> .....	27
3.2.11 <i>PCI-104 Connector</i> .....	28
3.2.12 <i>PCIe Mini Card Slots</i> .....	29

## NOVA-HM551 5.25" SBC

3.2.13 PCI Express x16 Slot.....	31
3.2.14 Power Connector (+12V) .....	33
3.2.15 Power Button .....	34
3.2.16 SATA Drive Connectors .....	34
3.2.17 SATA Power Connectors .....	35
3.2.18 Serial Port Connector (RS-232).....	36
3.2.19 Serial Port Connectors (RS-232/422/485).....	37
3.2.20 SMBus Connector .....	38
3.2.21 SPI Flash Connector.....	39
3.2.22 USB Connectors.....	40
3.2.23 VGA Connector (Internal) .....	41
3.3 EXTERNAL PERIPHERAL INTERFACE CONNECTOR PANEL .....	42
3.3.1 Ethernet Connector.....	43
3.3.2 HDMI Connectors.....	44
<b>4 INSTALLATION.....</b>	<b>45</b>
4.1 ANTI-STATIC PRECAUTIONS .....	46
4.2 INSTALLATION CONSIDERATIONS.....	47
4.2.1 Installation Notices .....	47
4.3 UNPACKING.....	48
4.4 CPU, CPU COOLING KIT AND SO-DIMM INSTALLATION.....	48
4.4.1 Socket G1 CPU Installation.....	49
4.4.2 Socket G1 Cooling Kit Installation.....	51
4.4.3 SO-DIMM Installation.....	53
4.5 JUMPER SETTINGS .....	54
4.5.1 AT/ATX Power Select.....	55
4.5.2 Clear CMOS.....	55
4.5.3 COM 5 Function Select.....	57
4.5.4 COM 6 Function Select.....	57
4.5.5 LVDS Voltage Select.....	58
4.5.6 LVDS Panel Resolution Select.....	59
4.5.7 PCI-104 Voltage Setup.....	60
4.6 CHASSIS INSTALLATION.....	61
4.6.1 Airflow.....	61
4.6.2 Motherboard Installation.....	62

4.7 INTERNAL PERIPHERAL DEVICE CONNECTIONS.....	62
4.7.1 Audio Kit Installation.....	62
4.7.2 Keyboard/Mouse Connector.....	63
4.7.3 PCIe Mini Card Installation.....	65
4.7.4 SATA Drive Connection.....	65
4.7.5 Four Serial Port Connector.....	66
4.7.6 USB Cable.....	67
4.8 EXTERNAL PERIPHERAL INTERFACE CONNECTION.....	69
4.8.1 HDMI Display Device Connection.....	69
4.8.2 LAN Connection.....	70
4.9 SOFTWARE INSTALLATION.....	71
<b>5 BIOS SCREENS.....</b>	<b>73</b>
5.1 INTRODUCTION.....	74
5.1.1 Starting Setup.....	74
5.1.2 Using Setup.....	74
5.1.3 Getting Help.....	75
5.1.4 Unable to Reboot After Configuration Changes.....	75
5.1.5 BIOS Menu Bar.....	75
5.2 MAIN.....	76
5.3 ADVANCED.....	77
5.3.1 ACPI Configuration.....	78
5.3.2 Trusted Computing.....	79
5.3.3 CPU Configuration.....	80
5.3.4 SATA Configuration.....	81
5.3.5 USB Configuration.....	82
5.3.6 Super IO Configuration.....	84
5.3.6.1 COM n Configuration.....	84
5.3.7 H/W Monitor.....	91
5.3.8 Serial Port Console Redirection.....	94
5.3.8.1 Console Redirection Settings.....	95
5.4 CHIPSET.....	96
5.4.1 North Bridge Configuration.....	97
5.4.2 South Bridge Configuration.....	98
5.4.3 Intel IGD SWSCI OpRegion.....	100

## NOVA-HM551 5.25" SBC

5.5 BOOT.....	102
5.6 SECURITY.....	103
5.7 EXIT.....	104
<b>A BIOS MENU OPTIONS .....</b>	<b>106</b>
<b>B ONE KEY RECOVERY.....</b>	<b>109</b>
B.1 ONE KEY RECOVERY INTRODUCTION .....	110
<i>B.1.1 System Requirement.....</i>	<i>111</i>
<i>B.1.2 Supported Operating System.....</i>	<i>112</i>
B.2 SETUP PROCEDURE FOR WINDOWS .....	113
<i>B.2.1 Hardware and BIOS Setup .....</i>	<i>113</i>
<i>B.2.2 Create Partitions .....</i>	<i>114</i>
<i>B.2.3 Install Operating System, Drivers and Applications.....</i>	<i>117</i>
<i>B.2.4 Build-up Recovery Partition.....</i>	<i>118</i>
<i>B.2.5 Create Factory Default Image.....</i>	<i>120</i>
B.3 SETUP PROCEDURE FOR LINUX .....	125
B.4 RECOVERY TOOL FUNCTIONS .....	128
<i>B.4.1 Factory Restore .....</i>	<i>130</i>
<i>B.4.2 Backup System.....</i>	<i>131</i>
<i>B.4.3 Restore Your Last Backup.....</i>	<i>132</i>
<i>B.4.4 Manual.....</i>	<i>133</i>
B.5 OTHER INFORMATION .....	134
<i>B.5.1 Using AHCI Mode or ALi M5283 / VIA VT6421A Controller.....</i>	<i>134</i>
<i>B.5.2 System Memory Requirement .....</i>	<i>136</i>
<b>C TERMINOLOGY.....</b>	<b>137</b>
<b>D WATCHDOG TIMER .....</b>	<b>142</b>
<b>E HAZARDOUS MATERIALS DISCLOSURE.....</b>	<b>145</b>
E.1 HAZARDOUS MATERIAL DISCLOSURE TABLE FOR IPB PRODUCTS CERTIFIED AS ROHS COMPLIANT UNDER 2002/95/EC WITHOUT MERCURY .....	146

# List of Figures

---

Figure 1-1: NOVA-HM551 .....	2
Figure 1-2: Connectors .....	3
Figure 1-3: NOVA-HM551 Dimensions (mm).....	4
Figure 1-4: NOVA-HM551 EPIC Dimensions (mm) .....	5
Figure 1-5: Data Flow Block Diagram .....	6
Figure 3-1: Connector and Jumper Locations.....	15
Figure 3-2: Audio Connector Location .....	18
Figure 3-3: Battery Connector Location.....	19
Figure 3-4: Digital I/O Connector Locations .....	20
Figure 3-5: CPU Fan Connector Location .....	21
Figure 3-6: +12V Fan Connector Locations .....	22
Figure 3-7: Front Panel Connector Location .....	23
Figure 3-8: Keyboard/Mouse Connector Location .....	24
Figure 3-9: Backlight Inverter Connector Location.....	25
Figure 3-10: LVDS Connector Location.....	26
Figure 3-11: Parallel Port Connector Location .....	27
Figure 3-12: PCI-104 Connector Location .....	28
Figure 3-13: PCIe Mini Card Slot Location .....	30
Figure 3-14: PCIe x16 Slot Location .....	31
Figure 3-15: CPU 12V Power Connector Location .....	33
Figure 3-16: Power Button Location.....	34
Figure 3-17: SATA Drive Connector Locations .....	35
Figure 3-18: SATA Power Connector Locations .....	36
Figure 3-19: COM Connector Pinout Locations .....	36
Figure 3-20: Serial Port Connector Location .....	38
Figure 3-21: SMBus Connector Location .....	39
Figure 3-22: SPI Flash Connector Locations.....	40
Figure 3-23: USB Connector Pinout Locations .....	40
Figure 3-24: VGA Connector Location .....	41
Figure 3-25: NOVA-HM551 External Peripheral Interface Connector.....	42
Figure 3-26: RJ-45 Ethernet Connector.....	43



## NOVA-HM551 5.25" SBC

Figure 4-1: Make sure the CPU socket retention screw is unlocked .....	50
Figure 4-2: Lock the CPU Socket Retention Screw.....	51
Figure 4-3: Cooling Kit Support Bracket.....	52
Figure 4-4: SO-DIMM Installation .....	53
Figure 4-5: Jumper Locations .....	54
Figure 4-6: AT/ATX Power Select Jumper Location.....	55
Figure 4-7: Clear CMOS Jumper .....	56
Figure 4-8: COM 5 Function Select Jumper Location.....	57
Figure 4-9: COM 6 Function Select Jumper Location.....	58
Figure 4-10: LVDS Voltage Selection Jumper Locations .....	59
Figure 4-11: LVDS Panel Resolution Jumper Pinout Locations.....	60
Figure 4-12: PCI-104 Voltage Jumper Location.....	61
Figure 4-13: Audio Kit Cable Connection .....	63
Figure 4-14: Keyboard/mouse Y-cable Connection .....	64
Figure 4-15: PCIe Mini Card Installation.....	65
Figure 4-16: SATA Drive Connection.....	66
Figure 4-17: Four Serial Port Connector .....	67
Figure 4-18: Serial Device Connector.....	67
Figure 4-19: Dual USB Cable Connection .....	68
Figure 4-20: HDMI Connection .....	69
Figure 4-21: LAN Connection .....	70
Figure 4-22: Introduction Screen .....	71
Figure 4-23: Available Drivers .....	72
Figure B-1: IEI One Key Recovery Tool Menu .....	110
Figure B-2: Launching the Recovery Tool .....	114
Figure B-3: Recovery Tool Setup Menu .....	115
Figure B-4: Command Mode.....	115
Figure B-5: Partition Creation Commands.....	116
Figure B-6: Launching the Recovery Tool .....	118
Figure B-7: System Configuration for Windows .....	118
Figure B-8: Build-up Recovery Partition .....	119
Figure B-9: Press any key to continue .....	119
Figure B-10: Press F3 to Boot into Recovery Mode.....	120
Figure B-11: Recovery Tool Menu .....	120
Figure B-12: About Symantec Ghost Window.....	121



Figure B-13: Symantec Ghost Path ..... 121

Figure B-14: Select a Local Source Drive ..... 122

Figure B-15: Select a Source Partition from Basic Drive ..... 122

Figure B-16: File Name to Copy Image to ..... 123

Figure B-17: Compress Image..... 123

Figure B-18: Image Creation Confirmation ..... 124

Figure B-19: Image Creation Process..... 124

Figure B-20: Image Creation Complete ..... 124

Figure B-21: Press Any Key to Continue ..... 125

Figure B-22: Partitions for Linux..... 126

Figure B-23: System Configuration for Linux..... 127

Figure B-24: Access menu.lst in Linux (Text Mode)..... 127

Figure B-25: Recovery Tool Menu ..... 128

Figure B-26: Recovery Tool Main Menu ..... 129

Figure B-27: Restore Factory Default..... 130

Figure B-28: Recovery Complete Window ..... 130

Figure B-29: Backup System..... 131

Figure B-30: System Backup Complete Window ..... 131

Figure B-31: Restore Backup ..... 132

Figure B-32: Restore System Backup Complete Window ..... 132

Figure B-33: Symantec Ghost Window ..... 133

# List of Tables

<b>Table 1-1: Technical Specifications.....</b>	<b>8</b>
<b>Table 3-1: Peripheral Interface Connectors.....</b>	<b>17</b>
<b>Table 3-2: Rear Panel Connectors.....</b>	<b>17</b>
<b>Table 3-3: Audio Connector Pinouts.....</b>	<b>18</b>
<b>Table 3-4: Battery Connector Pinouts.....</b>	<b>19</b>
<b>Table 3-5: Digital I/O Connector Pinouts.....</b>	<b>20</b>
<b>Table 3-6: CPU Fan Connector Pinouts.....</b>	<b>21</b>
<b>Table 3-7: +12V Fan Connector Pinouts.....</b>	<b>22</b>
<b>Table 3-8: Front Panel Connector Pinouts.....</b>	<b>23</b>
<b>Table 3-9: Keyboard/Mouse Connector Pinouts.....</b>	<b>24</b>
<b>Table 3-10: Backlight Inverter Connector Pinouts.....</b>	<b>25</b>
<b>Table 3-11: LVDS Connector Pinouts.....</b>	<b>26</b>
<b>Table 3-12: Parallel Port Connector Pinouts.....</b>	<b>27</b>
<b>Table 3-13: PCI-104 Connector Pinouts.....</b>	<b>29</b>
<b>Table 3-14: PCIe Mini Card Slot Pinouts.....</b>	<b>31</b>
<b>Table 3-15: PCIe x16 Side A Pinouts.....</b>	<b>32</b>
<b>Table 3-16: PCIe x16 Side B Pinouts.....</b>	<b>33</b>
<b>Table 3-17: CPU 12V Power Connector Pinouts.....</b>	<b>33</b>
<b>Table 3-18: SATA Drive Connector Pinouts.....</b>	<b>35</b>
<b>Table 3-19: SATA Power Connector Pinouts.....</b>	<b>36</b>
<b>Table 3-20: Serial Port Connector Pinouts.....</b>	<b>37</b>
<b>Table 3-21: Serial Port Connector Pinouts.....</b>	<b>38</b>
<b>Table 3-22: SMBus Connector Pinouts.....</b>	<b>39</b>
<b>Table 3-23: SPI Flash Connector Pinouts.....</b>	<b>40</b>
<b>Table 3-24: USB Port Connector Pinouts.....</b>	<b>41</b>
<b>Table 3-25: VGA Connector Pinouts.....</b>	<b>41</b>
<b>Table 3-26: LAN Pinouts.....</b>	<b>43</b>
<b>Table 3-27: RJ-45 Ethernet Connector LEDs.....</b>	<b>43</b>
<b>Table 3-28: HDMI Connector Pinouts.....</b>	<b>44</b>
<b>Table 4-1: Jumpers.....</b>	<b>54</b>
<b>Table 4-2: AT/ATX Power Select Jumper Settings.....</b>	<b>55</b>

<b>Table 4-3: Clear CMOS Jumper Settings.....</b>	<b>56</b>
<b>Table 4-4: COM 5 Function Select Jumper Settings .....</b>	<b>57</b>
<b>Table 4-5: COM 6 Function Select Jumper Settings .....</b>	<b>58</b>
<b>Table 4-6: LVDS Voltage Selection Jumper Settings.....</b>	<b>59</b>
<b>Table 4-7: LVDS1 Panel Resolution Jumper Setting.....</b>	<b>60</b>
<b>Table 4-8: PCI-104 Voltage Jumper Settings .....</b>	<b>61</b>
<b>Table 5-1: BIOS Navigation Keys .....</b>	<b>75</b>

# List of BIOS Menus

---

BIOS Menu 1: Main .....	76
BIOS Menu 2: Advanced .....	77
BIOS Menu 3: ACPI Configuration .....	78
BIOS Menu 4: TPM Configuration .....	79
BIOS Menu 5: CPU Configuration .....	80
BIOS Menu 6: IDE Configuration .....	81
BIOS Menu 7: USB Configuration .....	82
BIOS Menu 8: Super IO Configuration.....	84
BIOS Menu 9: COM n Configuration Menu.....	84
BIOS Menu 10: Hardware Health Configuration .....	91
BIOS Menu 11: Serial Port Console Redirection .....	94
BIOS Menu 12: Console Redirection Settings.....	95
BIOS Menu 13: Chipset .....	96
BIOS Menu 14:North Bridge Chipset Configuration .....	97
BIOS Menu 15:South Bridge Chipset Configuration.....	98
BIOS Menu 16: Intel IGD SWSCI OpRegion .....	100
BIOS Menu 17: Boot .....	102
BIOS Menu 18: Security .....	103
BIOS Menu 19:Exit.....	104



Chapter

1

# Introduction

---

## 1.1 Introduction

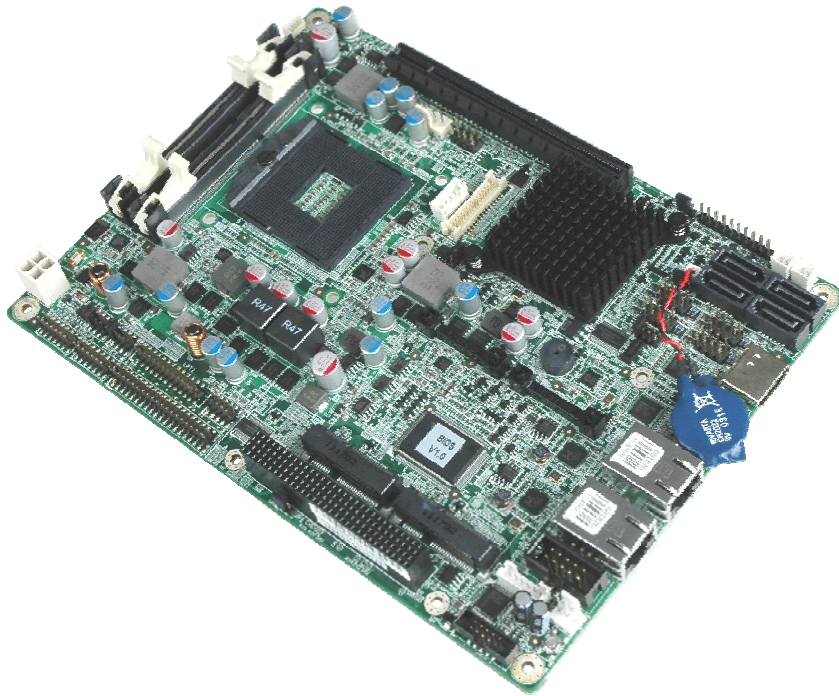

**Figure 1-1: NOVA-HM551**

The NOVA-HM551 5.25" motherboard is a Socket G1 32nm Intel® Core™ i3, i5 and i7 processor platform. Up to two 4.0 GB 800 MHz or 1066 MHz DDR3 SDRAM SO-DIMMs are supported by the NOVA-HM551.

The integrated Intel® HM55 Express Chipset supports two GbE LAN port through the dual Realtek RTL8111E Ethernet controllers (with ASF 2.0 support). The NOVA-HM551 also supports four SATA 3Gb/s drives and provides 5 V SATA power.

The NOVA-HM551 supports dual display via VGA, two HDMI and an internal LVDS connector. Eight USB 2.0 channels, one PCIe x16 socket, two PCIe mini sockets and one PCI-104 slot provide flexible expansion options. High Definition Audio (HDA) support ensures HDA devices can be easily implemented on the NOVA-HM551. Serial device connectivity is provided by four internal RS-232 and two internal RS-232/422/485 connectors.



# NOVA-HM551 5.25" SBC

## 1.2 Connectors

The connectors on the NOVA-HM551 are shown in the figure below.

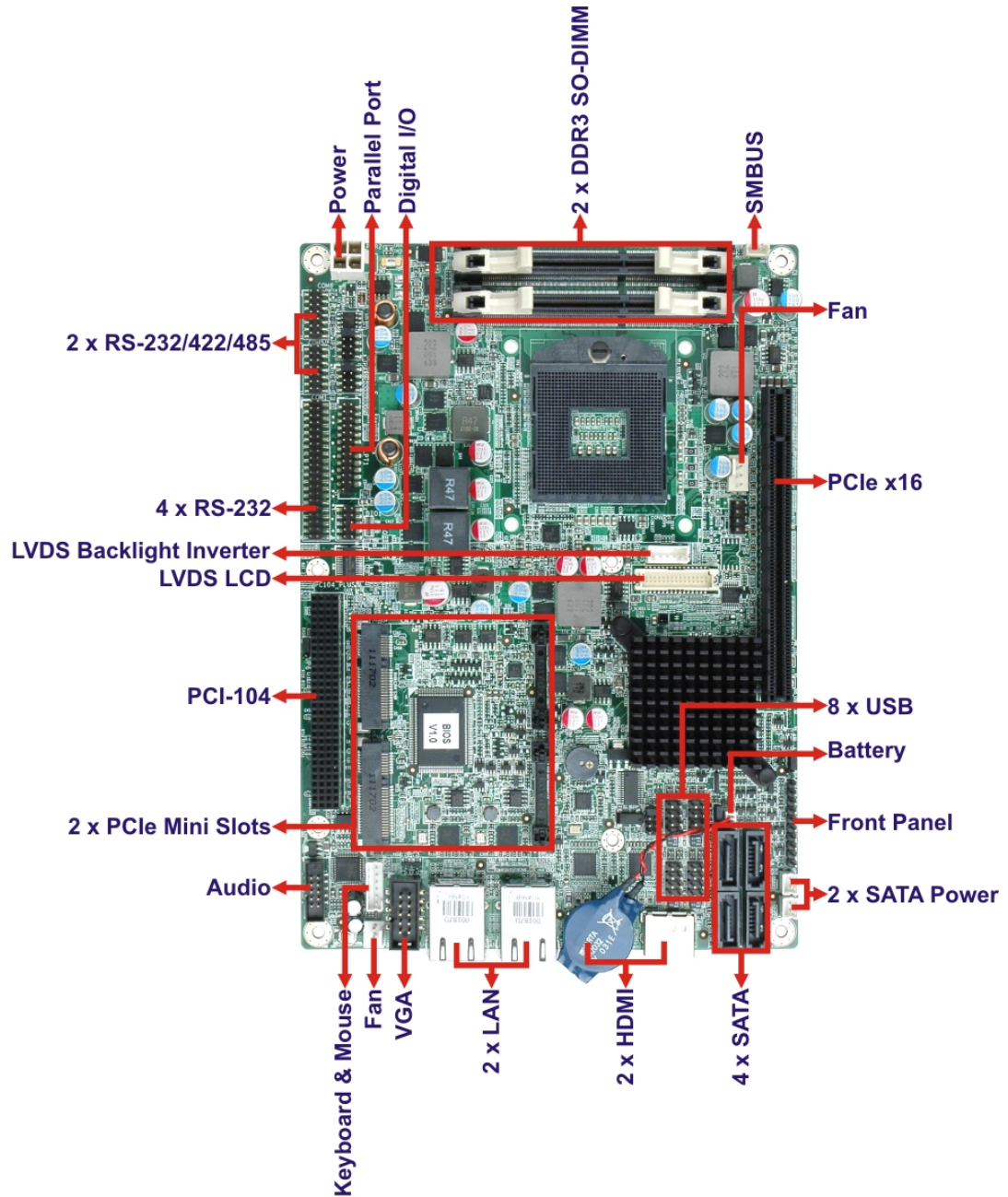

Figure 1-2: Connectors

### 1.3 Dimensions

The dimensions of the board are listed below:

- **Length:** 203.20 mm
- **Width:** 146.05 mm

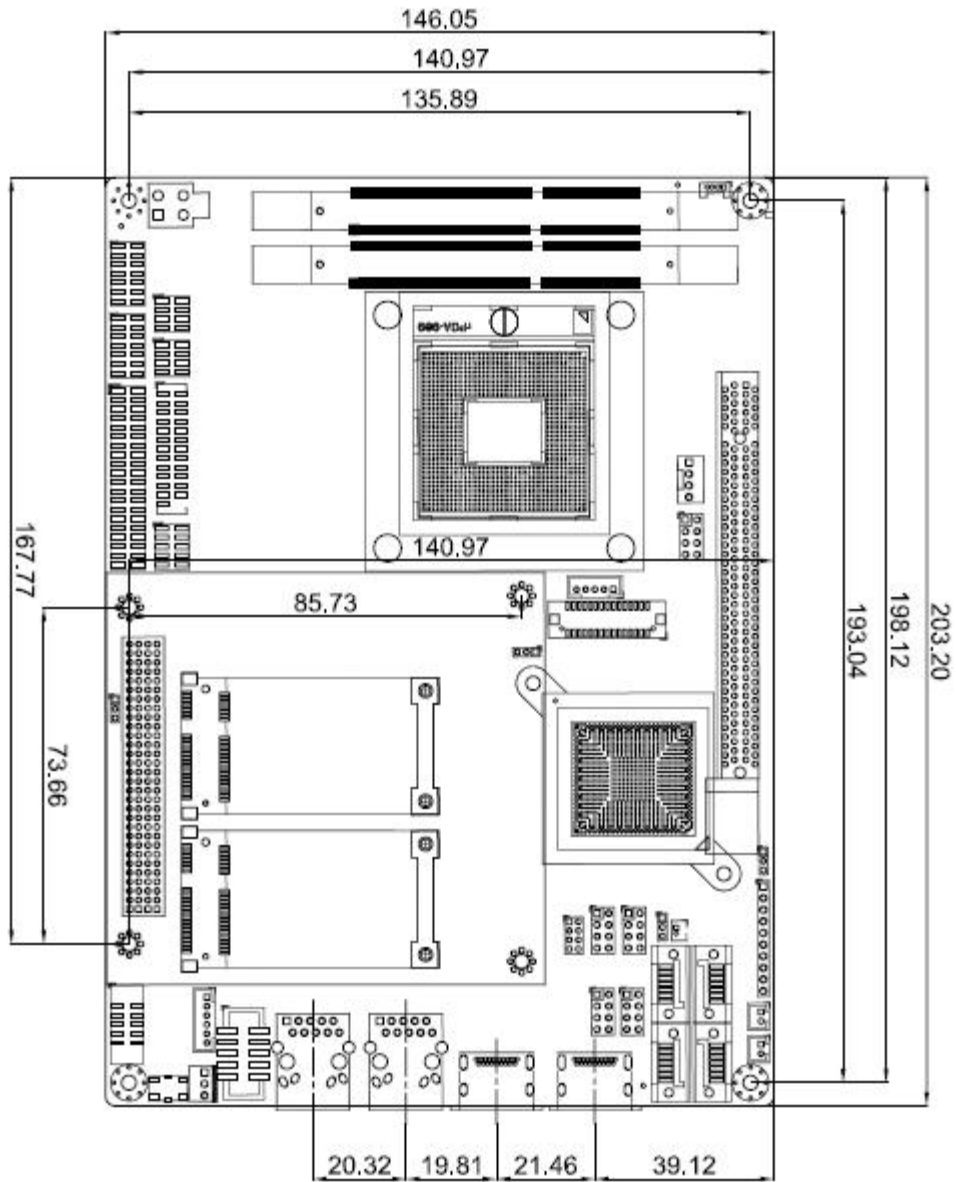

Figure 1-3: NOVA-HM551 Dimensions (mm)



Figure 1-4: NOVA-HM551 EPIC Dimensions (mm)

### 1.4 Data Flow

Figure 1-5 shows the data flow between the two on-board chipsets and other components installed on the motherboard and described in the following sections of this chapter.

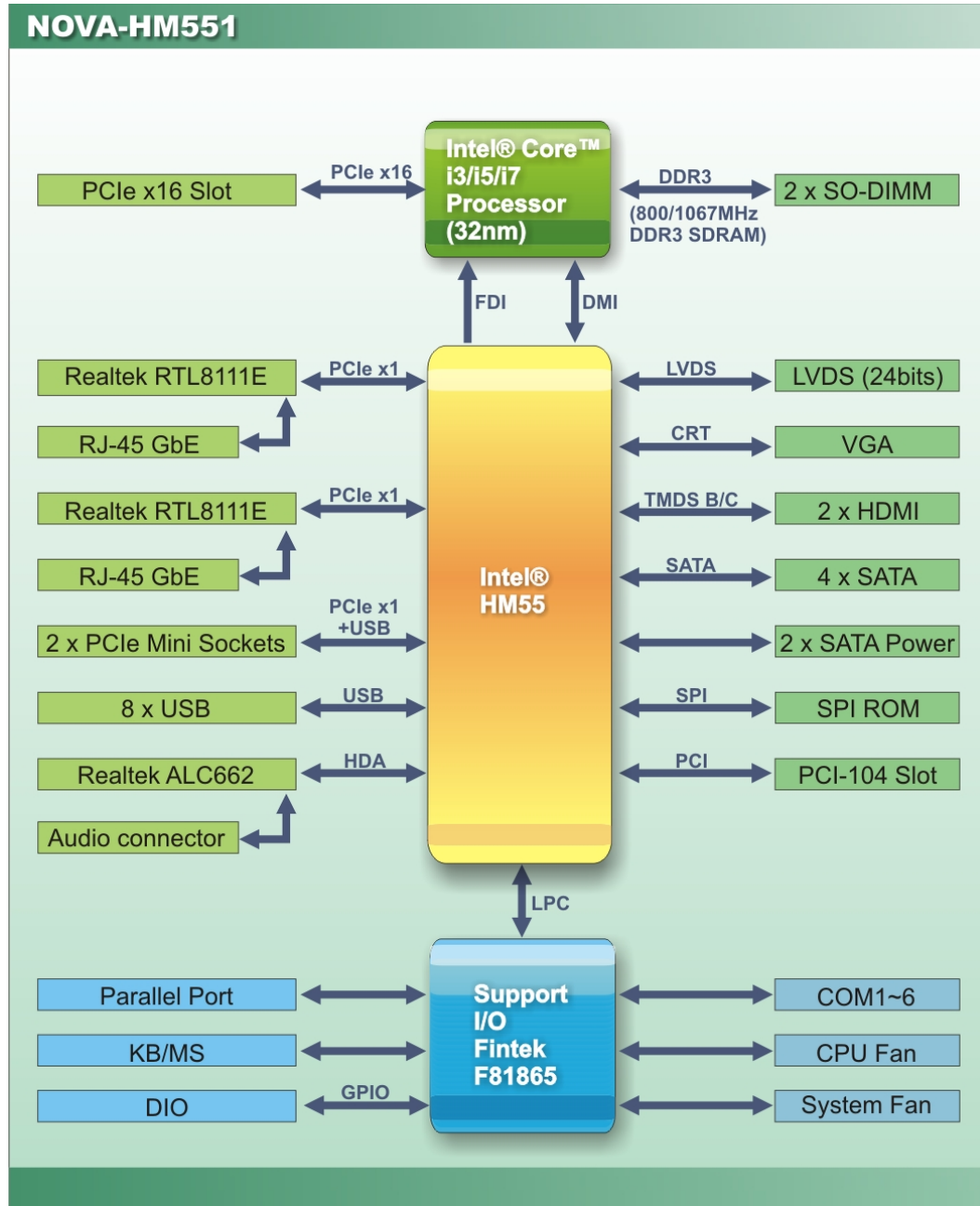

Figure 1-5: Data Flow Block Diagram

## NOVA-HM551 5.25" SBC

### 1.5 Technical Specifications

NOVA-HM551 technical specifications are listed in table below.

Specification	NOVA-HM551
<b>Form Factor</b>	5.25"
<b>Socket</b>	Socket G1 (rPGA988A)
<b>CPU Supported</b>	32 nm Intel® Core™ i3 processor 32 nm Intel® Core™ i5 processor 32 nm Intel® Core™ i7 processor (the i7 dual-core series supports integrated graphics but not the i7 quad-core series)
<b>Express Chipset</b>	Intel® HM55
<b>Memory</b>	Two 204-pin SO-DIMM sockets support two 800/1066 MHz DDR3 SDRAM SO-DIMMs (system max. 8 GB)
<b>Graphics Engine</b>	Gen 5.75 with 12 Execution Units DirectX* 10, OpenGL* 2.1
<b>Audio</b>	Realtek ALC662 (5.1 channel HD Audio codec)
<b>LAN</b>	Dual Realtek RTL8111E PCIe GbE controllers (LAN1 with ASF 2.0 support)
<b>Super I/O</b>	Fintek F81865
<b>BIOS</b>	UEFI BIOS
<b>Digital I/O</b>	8-bit digital I/O (4-bit input/4-bit output)
<b>Watchdog Timer</b>	Software programmable supports 1~255 sec. system reset
<b>TPM</b>	Optional on-board Infineon SLB9635TT1.2 module
<b>Expansion</b>	
<b>PCIe</b>	Two PCIe Mini slots One PCIe x16 slot
<b>PCI-104</b>	One PCI-104 slot
<b>I/O Interface Connectors</b>	
<b>Audio Connector</b>	One internal audio connector (10-pin header)

Specification	NOVA-HM551
<b>Display Ports</b>	One internal VGA port (10-pin box header) Two HDMI port (up to 1080p) One internal 18/24-bit dual-channel LVDS connector
<b>Ethernet</b>	Two RJ-45 GbE ports
<b>Serial Ports</b>	Four RS-232 via one 40-pin header Two RS-232/422/485 via two 14-pin headers
<b>USB 2.0/1.1 Ports</b>	Eight internal USB ports via four 8-pin headers
<b>Parallel Port</b>	One internal parallel port via one 26-pin header
<b>Keyboard/Mouse</b>	One keyboard/mouse connector via one 6-pin wafer
<b>Fan Connectors</b>	One 4-pin CPU fan connector One 3-pin system fan connector
<b>SMBus</b>	One SMBus connector via one 4-pin wafer
<b>Storage</b>	
<b>Serial ATA</b>	Four SATA 3Gb/s connectors Two 5V SATA power connectors
<b>Environmental and Power Specifications</b>	
<b>Power Supply</b>	12 V only ATX and AT power supported
<b>Power Connector</b>	One internal 4-pin Molex power connector for power supply
<b>Power Consumption</b>	12V@4.67A (2.66 GHz Intel® Core™ i7 620M CPU with two 1333 MHz 4 GB DDR3 SO-DIMMs)
<b>Operating Temperature</b>	-10°C ~ 60°C (requires cooler and silicone heat sink paste)
<b>Humidity</b>	5% ~ 95% (non-condensing)
<b>Physical Specifications</b>	
<b>Dimensions</b>	203 mm x 146 mm
<b>Weight GW/NW</b>	800 g / 300 g

**Table 1-1: Technical Specifications**

Chapter

2

# Unpacking

---

## 2.1 Anti-static Precautions

---



### **WARNING!**

Static electricity can destroy certain electronics. Make sure to follow the ESD precautions to prevent damage to the product, and injury to the user.

---

Make sure to adhere to the following guidelines:

- ***Wear an anti-static wristband:*** Wearing an anti-static wristband can prevent electrostatic discharge.
- ***Self-grounding:*** Touch a grounded conductor every few minutes to discharge any excess static buildup.
- ***Use an anti-static pad:*** When configuring any circuit board, place it on an anti-static mat.
- ***Only handle the edges of the PCB:*** Don't touch the surface of the motherboard. Hold the motherboard by the edges when handling.

## 2.2 Unpacking Precautions

When the NOVA-HM551 is unpacked, please do the following:

- Follow the antistatic guidelines above.
- Make sure the packing box is facing upwards when opening.
- Make sure all the packing list items are present.



## NOVA-HM551 5.25" SBC







### 2.3 Packing List







#### NOTE:

If any of the components listed in the checklist below are missing, do not proceed with the installation. Contact the IEI reseller or vendor the NOVA-HM551 was purchased from or contact an IEI sales representative directly by sending an email to [sales@iei.com.tw](mailto:sales@iei.com.tw).





The NOVA-HM551 is shipped with the following components:

Quantity	Item and Part Number	Image
1	NOVA-HM551 motherboard	
1	Audio cable (P/N: 32000-072100-RS)	
1	Keyboard and mouse Y cable (P/N: 32000-023800-RS)	
1	Quad RS-232 cable (P/N: 32100-147900-RS)	
2	SATA and 5 V power cable (P/N: 32801-000201-100-RS)	
1	USB cable (P/N: 32000-044300-RS)	



1	VGA cable (P/N: 32000-033800-RS)	
1	Mini jumper pack (2.0mm) (P/N: 33100-000033-RS)	
1	Utility CD	
1	Quick Installation Guide	

### 2.3.1 Optional Items

The following are optional components which may be separately purchased:

Item and Part Number	Image
CPU cooler for 55 W mobile processor (P/N: CF-989A-RS-R11)	
CPU cooler for 50 W mobile processor (P/N: CF-989B-RS)	
Dual USB cable (w bracket) (P/N:CB-USB02A-RS)	
LPT cable (wo bracket) (P/N: 32200-015100-RS)	

**NOVA-HM551 5.25" SBC**

<p>SATA to IDE/CompactFlash® converter board (P/N: SAIDE-KIT01-R10)</p>	
<p>RS-232/422/485 cable (P/N: 32205-000300-100-RS)</p>	

Chapter

3

# Connectors

---

## NOVA-HM551 5.25" SBC

### 3.1 Peripheral Interface Connectors

This chapter details all the jumpers and connectors.

#### 3.1.1 NOVA-HM551 Layout

The figures below show all the connectors and jumpers.

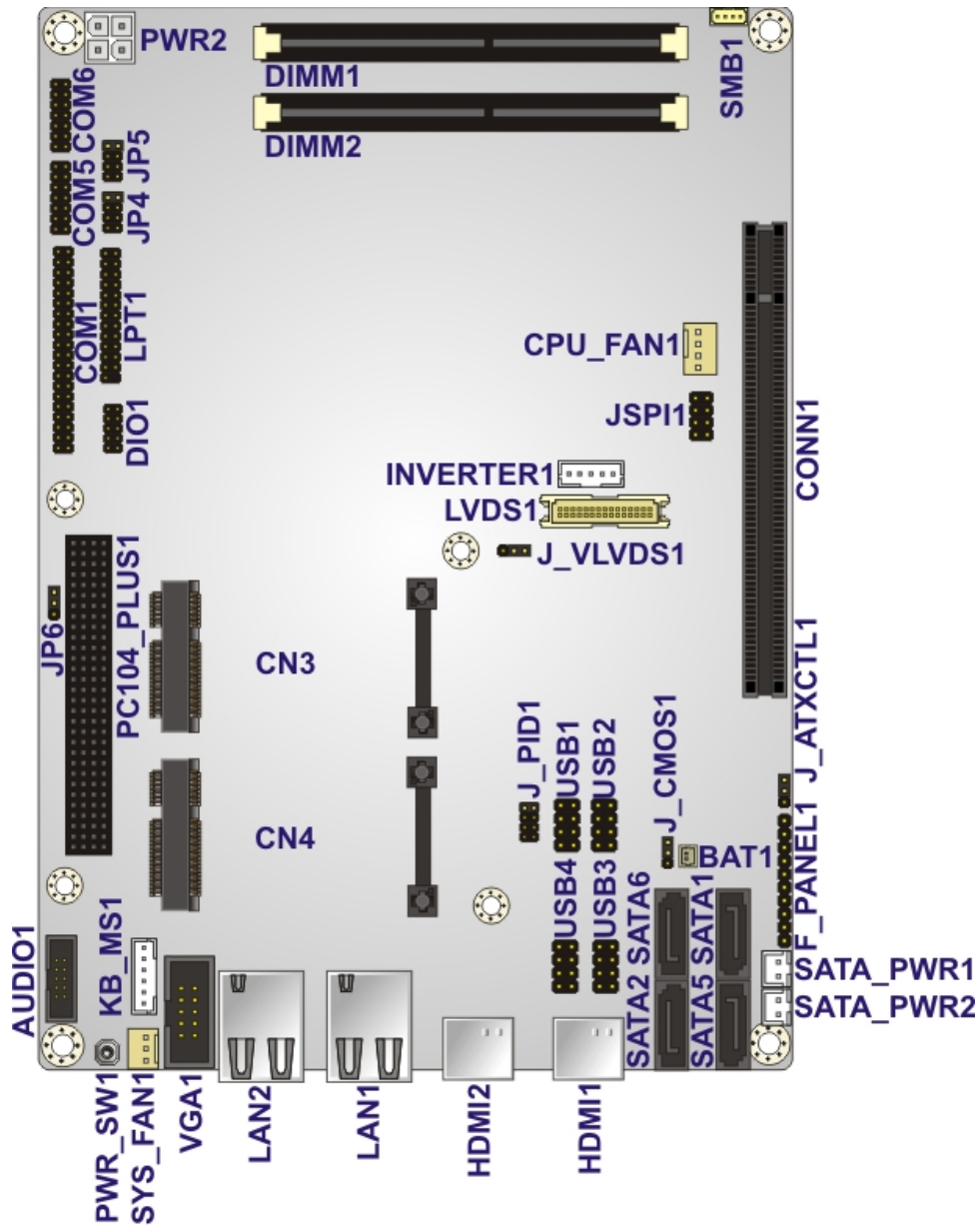

Figure 3-1: Connector and Jumper Locations

### 3.1.2 Peripheral Interface Connectors

The table below lists all the connectors on the board.

Connector	Type	Label
Audio connector	10-pin box header	AUDIO1
Battery connector	2-pin wafer	BAT1
DDR3 SO-DIMM socket	204-pin socket	DIMM1
DDR3 SO-DIMM socket	204-pin socket	DIMM2
Digital I/O connector	10-pin header	DIO1
Fan connector (CPU)	4-pin wafer	CPU_FAN1
Fan connector (system)	3-pin wafer	SYS_FAN1
Front panel connector	10-pin header	F_PANEL1
Keyboard and mouse connector	6-pin wafer	KB_MS1
LVDS backlight inverter connector	5-pin wafer	INVERTER1
LVDS LCD connector	30-pin crimp	LVDS1
Parallel port connector	25-pin header	LPT1
PCI-104 slot	PCI-104 slot	PC104_PLUS
PCIe Mini card slot	PCIe Mini card slot	CN3
PCIe Mini card slot	PCIe Mini card slot	CN4
PCIe x16 slot	PCIe x16 slot	CONN1
Power connector (+12V, power supply)	4-pin connector	PWR2
Power button	Push button	PWR_SW1
RS-232 serial port connector	40-pin header	COM1
RS-232/422/485 serial port connector	14-pin header	COM5

## NOVA-HM551 5.25" SBC

RS-232/422/485 serial port connector	14-pin header	COM6
Serial ATA (SATA) drive connector	7-pin SATA	S_ATA1
Serial ATA (SATA) drive connector	7-pin SATA	S_ATA2
Serial ATA (SATA) drive connector	7-pin SATA	S_ATA5
Serial ATA (SATA) drive connector	7-pin SATA	S_ATA6
SATA power connector	2-pin wafer	SATA_PWR1
SATA power connector	2-pin wafer	SATA_PWR2
SMBus connector	4-pin wafer	SMB1
SPI Flash connector	8-pin wafer	JSPI1
USB connector	8-pin header	USB1
USB connector	8-pin header	USB2
USB connector	8-pin header	USB3
USB connector	8-pin header	USB4
VGA connector	10-pin box header	VGA1

**Table 3-1: Peripheral Interface Connectors**

### 3.1.3 External Interface Panel Connectors

The table below lists the connectors on the external I/O panel.

Connector	Type	Label
Ethernet connector	RJ-45	LAN1
Ethernet connector	RJ-45	LAN2
HDMI	HDMI port	HDMI1
HDMI	HDMI port	HDMI2

**Table 3-2: Rear Panel Connectors**

## 3.2 Internal Peripheral Connectors

The section describes all of the connectors on the NOVA-HM551.

### 3.2.1 Audio Connector

- CN Label:**           **AUDIO1**
- CN Type:**            10-pin header (2x5)
- CN Location:**       See **Figure 3-2**
- CN Pinouts:**        See **Table 3-3**

The audio connector is connected to external audio devices including speakers and microphones for the input and output of audio signals to and from the system.

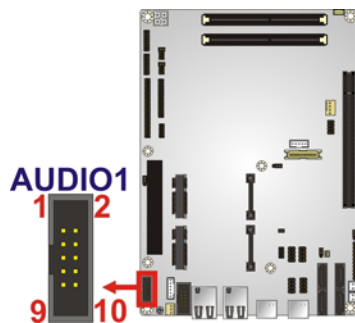

**Figure 3-2: Audio Connector Location**

Pin	Description	Pin	Description
1	MIC-L	2	ANALOG GND
3	MIC-R	4	PRESENCE#
5	LINE-R	6	MIC-JD
7	FRONT-IO	8	NC
9	LINE-L	10	INE-JD

**Table 3-3: Audio Connector Pinouts**



## NOVA-HM551 5.25" SBC

### 3.2.2 Battery Connector

- CN Label:** BAT1
- CN Type:** 2-pin wafer (1x2)
- CN Location:** See **Figure 3-3**
- CN Pinouts:** See **Table 3-4**

This is connected to the system battery. The battery provides power to the system clock to retain the time when power is turned off.

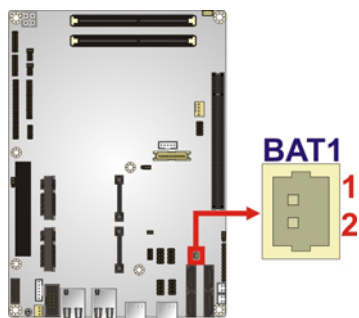

**Figure 3-3: Battery Connector Location**

Pin	Description
1	Battery+ (+3.3V)
2	Ground

**Table 3-4: Battery Connector Pinouts**

### 3.2.3 Digital I/O Connector

- CN Label:** DIO1
- CN Type:** 10-pin header
- CN Location:** See **Figure 3-4**
- CN Pinouts:** See **Table 3-5**

The digital I/O connector provides programmable input and output for external devices. The digital I/O provides 4-bit output and 4-bit input.

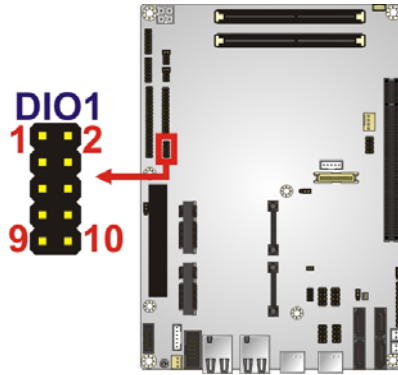

**Figure 3-4: Digital I/O Connector Locations**

Pin	Description	Pin	Description
1	GND	2	+5V
3	Output 3	4	Output 2
5	Output 1	6	Output 0
7	Input 3	8	Input 2
9	Input 1	10	Input 0

**Table 3-5: Digital I/O Connector Pinouts**

### 3.2.4 Fan Connector (CPU)

- CN Label:** CPU\_FAN1
- CN Type:** 4-pin wafer (1x4)
- CN Location:** See **Figure 3-5**
- CN Pinouts:** See **Table 3-6**

The fan connector attaches to a CPU cooling fan.

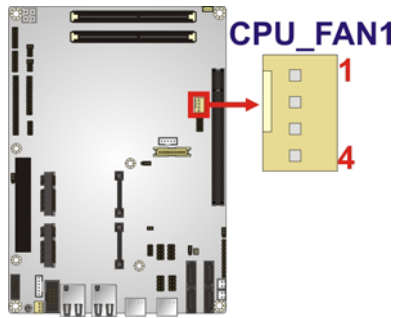

**Figure 3-5: CPU Fan Connector Location**

Pin	Description
1	GROUND
2	+12V
3	CPUFANIN
4	CPUFANOUT

**Table 3-6: CPU Fan Connector Pinouts**

### 3.2.5 Fan Connector (System)

- CN Label:**           **SYS\_FAN1**
- CN Type:**            3-pin wafer (1x3)
- CN Location:**       See **Figure 3-6**
- CN Pinouts:**        See **Table 3-7**

The cooling fan connector provides a 12V, 500mA current to the cooling fan. The connector has a "rotation" pin to get rotation signals from fans and notify the system so the system BIOS can recognize the fan speed. Please note that only specified fans can issue the rotation signals.

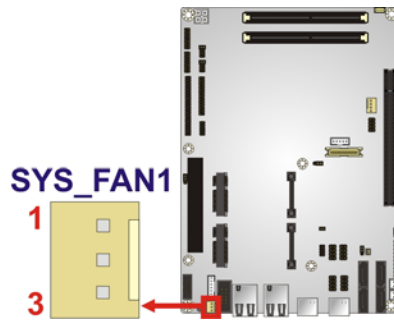

**Figure 3-6: +12V Fan Connector Locations**

Pin	Description
1	SYSFANINO
2	+12V
3	GND

**Table 3-7: +12V Fan Connector Pinouts**

### 3.2.6 Front Panel Connector

<b>CN Label:</b>	<b>F_PANEL1</b>
<b>CN Type:</b>	10-pin header (1x10)
<b>CN Location:</b>	See <b>Figure 3-7</b>
<b>CN Pinouts:</b>	See <b>Table 3-8</b>

The front panel connector connects to external switches and indicators to monitor and controls the motherboard. These indicators and switches include:

- Power button
- Reset
- Power LED
- HDD LED

## NOVA-HM551 5.25" SBC

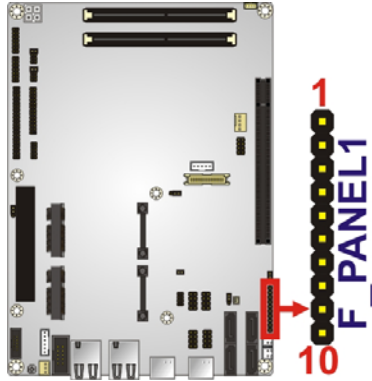

**Figure 3-7: Front Panel Connector Location**

Function	Pin	Description	Function	Pin	Description
	1	NC	Power LED	6	PWR_LED+
Power Button	2	PWR_BTN+		7	PWR_LED+
	3	PWR_BTN-		8	PWR_LED-
HDD LED	4	HDD_LED+	Reset	9	RESET+
	5	HDD_LED-		10	RESET-

**Table 3-8: Front Panel Connector Pinouts**

### 3.2.7 Keyboard/Mouse Connector

- CN Label:** KB\_MS1
- CN Type:** 6-pin wafer (1x6)
- CN Location:** See **Figure 3-8**
- CN Pinouts:** See **Table 3-9**

The keyboard/mouse connector connects to a PS/2 Y-cable that can be connected to a PS/2 keyboard and mouse.

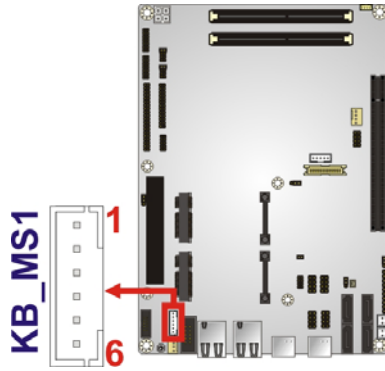

**Figure 3-8: Keyboard/Mouse Connector Location**

Pin	Description
1	+5 VCC
2	MS DATA
3	MS CLK
4	KB DATA
5	KB CLK
6	GROUND

**Table 3-9: Keyboard/Mouse Connector Pinouts**

### 3.2.8 Backlight Inverter Connector

- CN Label:** INVERTER1
- CN Type:** 5-pin wafer (1x5)
- CN Location:** See **Figure 3-9**
- CN Pinouts:** See **Table 3-10**

The backlight inverter connector provides power to an LCD panel.

# NOVA-HM551 5.25" SBC

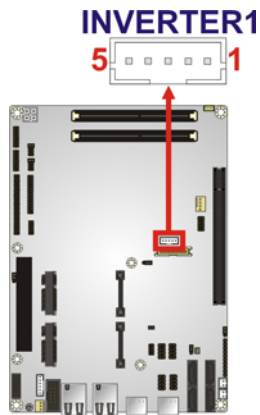

**Figure 3-9: Backlight Inverter Connector Location**

Pin	Description
1	BRIGHTNESS
2	GROUND1
3	+12 V
4	GROUND2
5	BACKLIGHT ENABLE

**Table 3-10: Backlight Inverter Connector Pinouts**

### 3.2.9 LVDS LCD Connector

- CN Label:** LVDS1
- CN Type:** 30-pin crimp (2x15)
- CN Location:** See **Figure 3-10**
- CN Pinouts:** See **Table 3-11**

The LVDS connector is for an LCD panel connected to the board.

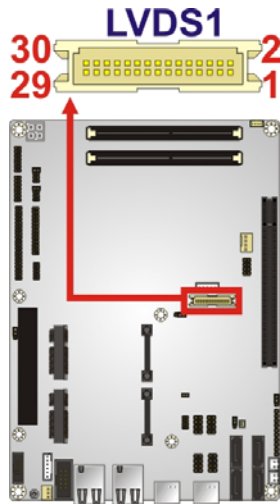

**Figure 3-10: LVDS Connector Location**

Pin	Description	Pin	Description
1	GND	2	GND
3	A_Y0	4	A_Y0#
5	A_Y1	6	A_Y1#
7	A_Y2	8	A_Y2#
9	A_CK	10	A_CK#
11	A_Y3	12	A_Y3#
13	GND	14	GND
15	B_Y0	16	B_Y0#
17	B_Y1	18	B_Y1#
19	B_Y2	20	B_Y2#
21	B_CK	22	B_CK#
23	B_Y3	24	B_Y3#
25	GND	26	GND
27	VCC_LCD	28	VCC_LCD
29	VCC_LCD	30	VCC_LCD

**Table 3-11: LVDS Connector Pinouts**



## NOVA-HM551 5.25" SBC

### 3.2.10 Parallel Port Connector

- CN Label:** LPT1
- CN Type:** 26-pin box header
- CN Location:** See **Figure 3-11**
- CN Pinouts:** See **Table 3-12**

The parallel port connector connects to a parallel port connector interface or some other parallel port device such as a printer.

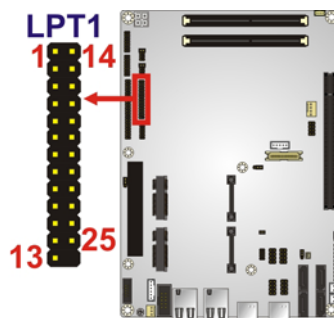

**Figure 3-11: Parallel Port Connector Location**

Pin	Description	Pin	Description
1	STROBE#	14	AUTO FORM FEED #
2	DATA0	15	ERROR#
3	DATA1	16	INITIALIZE#
4	DATA2	17	PRINTER SELECT LN#
5	DATA3	18	GND
6	DATA4	19	GND
7	DATA5	20	GND
8	DATA6	21	GND
9	DATA7	22	GND
10	ACKNOWLEDGE#	23	GND
11	BUSY	24	GND
12	PAPER EMPTY	25	GND
13	PRINTER SELECT	26	N/C

**Table 3-12: Parallel Port Connector Pinouts**

### 3.2.11 PCI-104 Connector

- CN Label:** PCI104\_PLUS1
- CN Type:** PCI-104 connector
- CN Location:** See **Figure 3-12**
- CN Pinouts:** See **Table 3-13**

The PCI-104 connector is for installing a PCI-104 expansion card.

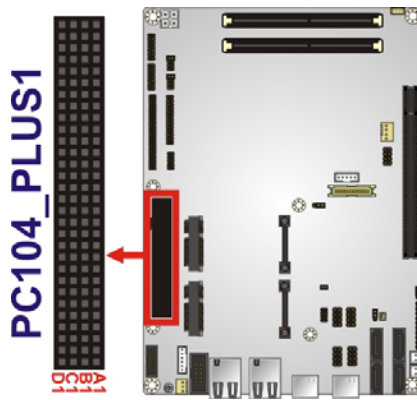

**Figure 3-12: PCI-104 Connector Location**

Pin	Row A	Row B	Row C	Row D
1	GND	RESERVED1	+5V	AD0
2	VIO1	AD2	AD1	+5V
3	AD5	GND	AD4	AD3
4	CBEO-	AD7	GND	AD6
5	GND	AD9	AD8	GND
6	AD11	VIO2	AD10	M66EN
7	AD14	AD13	GND	AD12
8	+3V	CBE1-	AD15	+3V
9	SERR-	GND	SBO-	PAR
10	GND	PERR-	+3V	SDONE
11	STOP-	+3V	LOCK-	GND
12	+3V	TRDY-	GND	DEVSEL-

## NOVA-HM551 5.25" SBC

Pin	Row A	Row B	Row C	Row D
13	FRAME-	GND	IRDY-	+3V
14	GND	AD16	+3V	CBE2-
15	AD18	+3V	AD17	GND
16	AD21	AD20	GND	AD19
17	+3V	AD23	AD22	+3V
18	IDSEL0	GND	IDSEL1-	IDSEL2
19	AD24	CBE3-	VIO4	IDSEL3
20	GND	AD26	AD25	GND
21	AD29	+5V	AD28	AD27
22	+5V	AD30	GND	AD31
23	REQ0-	GND	REQ1-	VIO5
24	GND	REQ2-	+5V	GNT0-
25	GNT1-	VIO3	GNT2-	GND
26	+5V	PCICLK0	GND	PCICLK1
27	PCICLK2	+5V	PCICLK3	GND
28	GND	INTD-	+5V	PCIRST-
29	+12V	INTA-	INTB-	INTC-
30	-12V	RESERVED2	RESERVED3	GND

**Table 3-13: PCI-104 Connector Pinouts**

### 3.2.12 PCIe Mini Card Slots

- CN Label:** CN3, CN4
- CN Type:** PCIe Mini card slot
- CN Location:** See **Figure 3-13**
- CN Pinouts:** See **Table 3-14**

The PCIe Mini card slot is for installing PCIe Mini expansion cards.

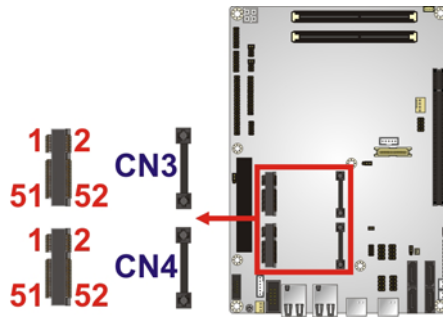
**Figure 3-13: PCIe Mini Card Slot Location**

Pin	Description	Pin	Description
1	PCIE_WAKE#	2	VCC3
3	N/C	4	GND
5	N/C	6	1.5V
7	N/C	8	N/C
9	GND	10	N/C
11	CLK-	12	N/C
13	CLK+	14	N/C
15	GND	16	N/C
17	PCIRST#	18	GND
19	N/C	20	VCC3
21	GND	22	PCIRST#
23	PERN2	24	3VDual
25	PERP2	26	GND
27	GND	28	1.5V
29	GND	30	SMBCLK
31	PETN2	32	SMBDATA
33	PETP2	34	GND
35	GND	36	USBD-
37	N/C	38	USBD+
39	N/C	40	GND
41	N/C	42	N/C
43	N/C	44	N/C
45	N/C	46	N/C
47	N/C	48	1.5V

## NOVA-HM551 5.25" SBC

Pin	Description	Pin	Description
49	N/C	50	GND
51	N/C	52	VCC3

**Table 3-14: PCIe Mini Card Slot Pinouts**

### 3.2.13 PCI Express x16 Slot

- CN Label:** CONN1
- CN Type:** PCIe x16 slot
- CN Location:** See **Figure 3-14**
- CN Pinouts:** See **Table 3-15** (Side A) **Table 3-16** (Side B)

The PCIe x16 expansion cards slot is for PCIe x16 expansion cards.

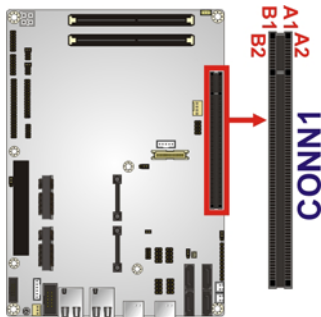

**Figure 3-14: PCIe x16 Slot Location**

Pin	Description	Pin	Description	Pin	Description	Pin	Description
A1	Name	A22	HSIn(1)	A43	HSIp(6)	A64	HSIp(11)
A2	PRSNT#1	A23	GND	A44	HSIn(6)	A65	HSIn(11)
A3	+12v	A24	GND	A45	GND	A66	GND
A4	+12v	A25	HSIp(2)	A46	GND	A67	GND
A5	GND	A26	HSIn(2)	A47	HSIp(7)	A68	HSIp(12)
A6	JTAG2	A27	GND	A48	HSIn(7)	A69	HSIn(12)
A7	JTAG3	A28	GND	A49	GND	A70	GND
A8	JTAG4	A29	HSIp(3)	A50	RSVD	A71	GND
A9	JTAG5	A30	HSIn(3)	A51	GND	A72	HSIp(13)
A10	+3.3v	A31	GND	A52	HSIp(8)	A73	HSIn(13)

Pin	Description	Pin	Description	Pin	Description	Pin	Description
A11	+3.3v	A32	RSVD	A53	HSIn(8)	A74	GND
A12	PWRGD	A33	RSVD	A54	GND	A75	GND
A13	GND	A34	GND	A55	GND	A76	HSIp(14)
A14	REFCLK+	A35	HSIp(4)	A56	HSIp(9)	A77	HSIn(14)
A15	REFCLK-	A36	HSIn(4)	A57	HSIn(9)	A78	GND
A16	GND	A37	GND	A58	GND	A79	GND
A17	HSIp(0)	A38	GND	A59	GND	A80	HSIp(15)
A18	HSIn(0)	A39	HSIp(5)	A60	HSIp(10)	A81	HSIn(15)
A19	GND	A40	HSIn(5)	A61	HSIn(10)	A82	GND
A20	RSVD	A41	GND	A62	GND		
A21	GND	A42	GND	A63	GND		

**Table 3-15: PCIe x16 Side A Pinouts**

Pin	Description	Pin	Description	Pin	Description	Pin	Description
B1	+12v	B22	GND	B43	GND	B64	GND
B2	+12v	B23	HSOp(2)	B44	GND	B65	GND
B3	RSVD	B24	HSOn(2)	B45	HSOp(7)	B66	HSOp(12)
B4	GND	B25	GND	B46	HSOn(7)	B67	HSOn(12)
B5	SMCLK	B26	GND	B47	GND	B68	GND
B6	SMDAT	B27	HSOp(3)	B48	PRSNT#2	B69	GND
B7	GND	B28	HSOn(3)	B49	GND	B70	HSOp(13)
B8	+3.3v	B29	GND	B50	HSOp(8)	B71	HSOn(13)
B9	JTAG1	B30	RSVD	B51	HSOn(8)	B72	GND
B10	3.3 Vaux	B31	PRSNT#2	B52	GND	B73	GND
B11	WAKE#	B32	GND	B53	GND	B74	HSOp(14)
B12	RSVD	B33	HSOp(4)	B54	HSOp(9)	B75	HSOn(14)
B13	GND	B34	HSOn(4)	B55	HSOn(9)	B76	GND
B14	HSOp(0)	B35	GND	B56	GND	B77	GND
B15	HSOn(0)	B36	GND	B57	GND	B78	HSOp(15)
B16	GND	B37	HSOp(5)	B58	HSOp(10)	B79	HSOn(15)
B17	PRSNT#2	B38	HSOn(5)	B59	HSOn(10)	B80	GND
B18	GND	B39	GND	B60	GND	B81	PRSNT#2

## NOVA-HM551 5.25" SBC

Pin	Description	Pin	Description	Pin	Description	Pin	Description
B19	HSOp(1)	B40	GND	B61	GND	B82	RSVD#2
B20	HSON(1)	B41	HSOp(6)	B62	HSOp(11)		
B21	GND	B42	HSON(6)	B63	HSON(11)		

**Table 3-16: PCIe x16 Side B Pinouts**

### 3.2.14 Power Connector (+12V)

- CN Label:** PWR2
- CN Type:** 4-pin Molex power connector (1x4)
- CN Location:** See **Figure 3-15**
- CN Pinouts:** See **Table 3-17**

The connector supports the 12V power supply.

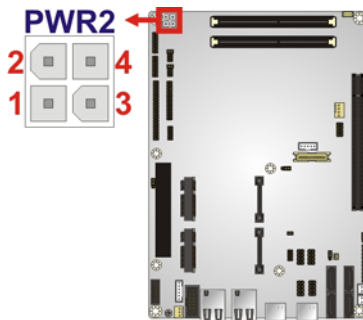

**Figure 3-15: CPU 12V Power Connector Location**

Pin	Description	Pin	Description
1	GND	2	GND
3	+12V	4	+12V

**Table 3-17: CPU 12V Power Connector Pinouts**

### 3.2.15 Power Button

<b>CN Label:</b>	<b>PWR_SW1</b>
<b>CN Type:</b>	Push button
<b>CN Location:</b>	See <b>Figure 3-16</b>

Use the on-board power button to power on/off the motherboard.

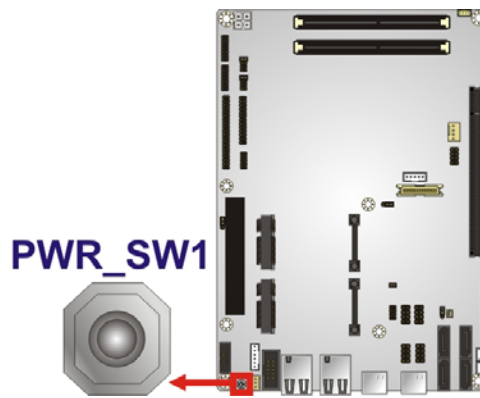

**Figure 3-16: Power Button Location**

### 3.2.16 SATA Drive Connectors

<b>CN Label:</b>	<b>S_ATA1, S_ATA2, S_ATA5, S_ATA6</b>
<b>CN Type:</b>	7-pin SATA drive connectors
<b>CN Location:</b>	See <b>Figure 3-17</b>
<b>CN Pinouts:</b>	See <b>Table 3-18</b>

The two SATA 3Gb/s drive connectors are each connected to a SATA 3Gb/s drive. The SATA 3Gb/s drives transfer data at speeds as high as 3.0 Gb/s.



# NOVA-HM551 5.25" SBC

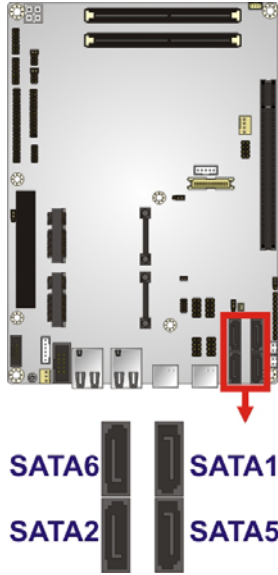

**Figure 3-17: SATA Drive Connector Locations**

Pin	Description
1	GND
2	TX+
3	TX-
4	GND
5	RX-
6	RX+
7	GND

**Table 3-18: SATA Drive Connector Pinouts**

### 3.2.17 SATA Power Connectors

- CN Label:** SATA\_PWR1, SATA\_PWR2
- CN Type:** 2-pin wafer (1x2)
- CN Location:** See **Figure 3-18**
- CN Pinouts:** See **Table 3-19**

The SATA Power Connectors provides +5V power output to the SATA connectors.

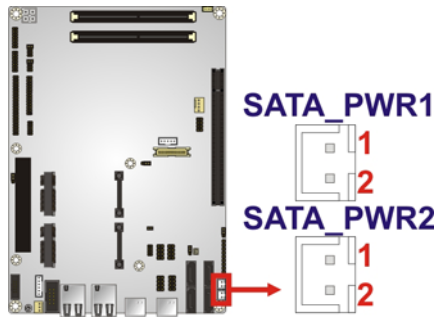

Figure 3-18: SATA Power Connector Locations

Pin	Description
1	+5V
2	GND

Table 3-19: SATA Power Connector Pinouts

### 3.2.18 Serial Port Connector (RS-232)

- CN Label:** COM1
- CN Type:** 40-pin header (2x20)
- CN Location:** See Figure 3-19
- CN Pinouts:** See Table 3-20

This connector provides RS-232 connections for four serial ports.

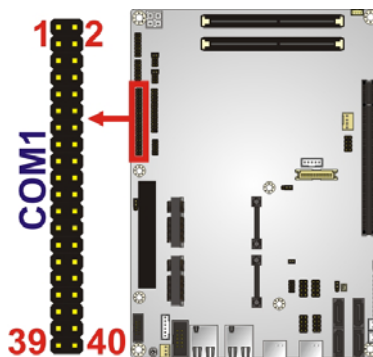

Figure 3-19: COM Connector Pinout Locations

## NOVA-HM551 5.25" SBC

Pin	Description	Pin	Description
1	DATA CARRIER DETECT (DCD1#)	2	DATA SET READY (DSR1#)
3	RECEIVE DATA (RXD1)	4	REQUEST TO SEND (RTS1#)
5	TRANSMIT DATA (TXD1)	6	CLEAR TO SEND (CTS1#)
7	DATA TERMINAL READY (DTR1#)	8	RING INDICATOR (RI1#)
9	GND	10	GND
11	DATA CARRIER DETECT (DCD2#)	12	DATA SET READY (DSR2#)
13	RECEIVE DATA (RXD2)	14	REQUEST TO SEND (RTS2#)
15	TRANSMIT DATA (TXD2)	16	CLEAR TO SEND (CTS2#)
17	DATA TERMINAL READY (DTR2#)	18	RING INDICATOR (RI2#)
19	GND	20	GND
21	DATA CARRIER DETECT (DCD3#)	22	DATA SET READY (DSR3#)
23	RECEIVE DATA (RXD3)	24	REQUEST TO SEND (RTS3#)
25	TRANSMIT DATA (TXD3)	26	CLEAR TO SEND (CTS3#)
27	DATA TERMINAL READY (DTR3#)	28	RING INDICATOR (RI3#)
29	GND	30	GND
31	DATA CARRIER DETECT (DCD4#)	32	DATA SET READY (DSR4#)
33	RECEIVE DATA (RXD4)	34	REQUEST TO SEND (RTS4#)
35	TRANSMIT DATA (TXD4)	36	CLEAR TO SEND (CTS4#)
37	DATA TERMINAL READY (DTR4#)	38	RING INDICATOR (RI4#)
39	GND	40	GND

**Table 3-20: Serial Port Connector Pinouts**

### 3.2.19 Serial Port Connectors (RS-232/422/485)

**CN Label:** COM5, COM6

**CN Type:** 14-pin header (2x7)

**CN Location:** See **Figure 3-20**

**CN Pinouts:** See **Table 3-21**

Used for RS-232/422/485 communications.

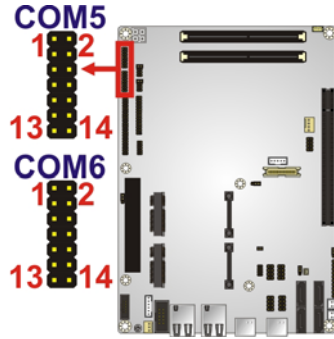

**Figure 3-20: Serial Port Connector Location**

Pin	DESCRIPTION	Pin	DESCRIPTION
1	DATA CARRIER DETECT (DCD#)	2	DATA SET READY (DSR#)
3	RECEIVE DATA (RXD)	4	REQUEST TO SEND (RTS#)
5	TRANSMIT DATA (TXD)	6	CLEAR TO SEND (CTS#)
7	DATA TERMINAL READY (DTR#)	8	RING INDICATOR (RI#)
9	GND	10	GND
11	TXD485+	12	TXD485#
13	RXD485+	14	RXD485#

**Table 3-21: Serial Port Connector Pinouts**

### 3.2.20 SMBus Connector

- CN Label:** SMB1
- CN Type:** 4-pin wafer
- CN Location:** See **Figure 3-21**
- CN Pinouts:** See **Table 3-22**

The SMBus (System Management Bus) connector provides low-speed system management communications.

## NOVA-HM551 5.25" SBC

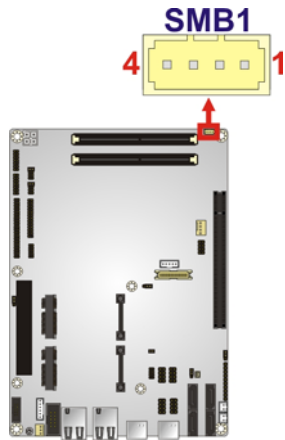

**Figure 3-21: SMBus Connector Location**

Pin	Description
1	GND
2	SMB_DATA
3	SMB_CLK
4	+5V

**Table 3-22: SMBus Connector Pinouts**

### 3.2.21 SPI Flash Connector

- CN Label:** JSPI1
- CN Type:** 8-pin wafer (1x6)
- CN Location:** See **Figure 3-22**
- CN Pinouts:** See **Table 3-23**

The 8-pin SPI Flash connector is used to flash the BIOS.

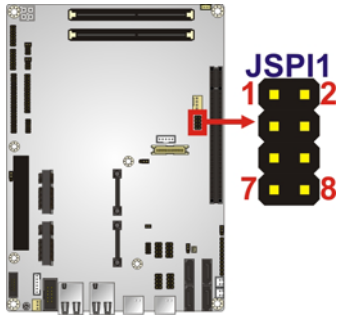

**Figure 3-22: SPI Flash Connector Locations**

Pin	Description	Pin	Description
1	SPI_VCC(+3.3V)	2	GND
3	SPI_CS#0	4	SPI_CLK
5	SPI_S00	6	SPI_SI
7	N/C	8	N/C

**Table 3-23: SPI Flash Connector Pinouts**

### 3.2.22 USB Connectors

**CN Label:** USB1, USB2, USB3, USB4

**CN Type:** 8-pin header (2x4)

**CN Location:** See **Figure 3-23**

**CN Pinouts:** See **Table 3-24**

The USB connectors connect to USB devices. Each pin header provides two USB ports.

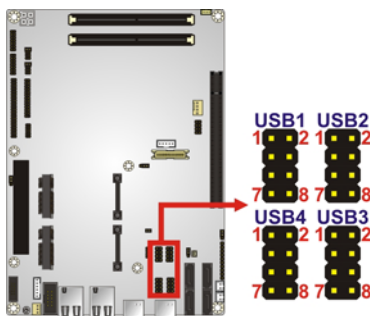

**Figure 3-23: USB Connector Pinout Locations**

## NOVA-HM551 5.25" SBC

Pin	Description	Pin	Description
1	VCC (+5V)	2	GND
3	DATA-	4	DATA+
5	DATA+	6	DATA-
7	GND	8	VCC (+5V)

**Table 3-24: USB Port Connector Pinouts**

### 3.2.23 VGA Connector (Internal)

- CN Label:** VGA1
- CN Type:** 10-pin box header
- CN Location:** See **Figure 3-24**
- CN Pinouts:** See **Table 3-25**

The VGA connector connects to a monitor.

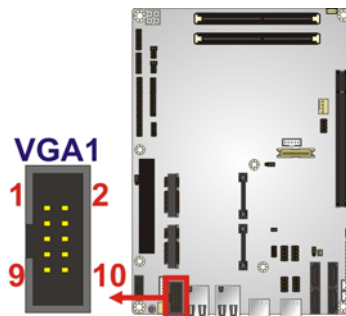

**Figure 3-24: VGA Connector Location**

Pin	Description	Pin	Description
1	RED	2	VDDCLK
3	GREEN	4	VDDCDA
5	BLUE	6	GND
7	HSYNC	8	GND
9	VSYNC	10	CRT_PLUG#

**Table 3-25: VGA Connector Pinouts**

**NOTE:**

The Intel® HD Graphics is **NOT** integrated in all the Intel® Core™ i7 Desktop processor family and Intel® Core™ i5-700 series processor. An additional graphic card must be installed in order to support display output. Otherwise, the display will show “No display output” when connected to the on-board VGA port.

**Reference Intel® Core™ i3 Desktop CPU:**

<http://ark.intel.com/ProductCollection.aspx?familyID=43129&MarketSegment=DT>

**Intel® Core™ i5 Desktop CPU:**

<http://ark.intel.com/ProductCollection.aspx?familyID=42912&MarketSegment=DT>

**Intel® Core™ i7 Desktop CPU:**

<http://ark.intel.com/ProductCollection.aspx?familyID=28037&MarketSegment=DT>

### 3.3 External Peripheral Interface Connector Panel

Figure 3-25 shows the NOVA-HM551 external peripheral interface connector (EPIC) panel. The NOVA-HM551 EPIC panel consists of the following:

- 2 x Ethernet connectors
- 2 x HDMI connectors

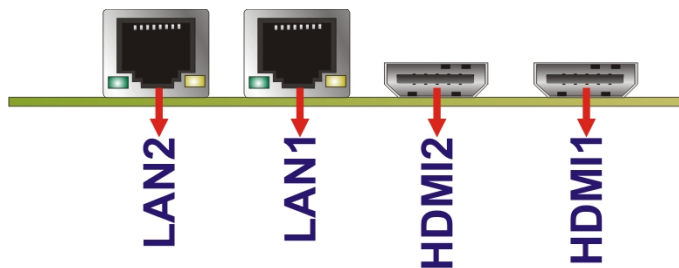

Figure 3-25: NOVA-HM551 External Peripheral Interface Connector



## NOVA-HM551 5.25" SBC

### 3.3.1 Ethernet Connector

<b>CN Label:</b>	<b>LAN1, LAN2</b>
<b>CN Type:</b>	<b>RJ-45</b>
<b>CN Location:</b>	<b>See Figure 3-25</b>
<b>CN Pinouts:</b>	<b>See Table 3-26</b>

The NOVA-HM551 is equipped with two built-in RJ-45 Ethernet controllers. Each controller can connect to the LAN through one RJ-45 LAN connector.

Pin	Description	Pin	Description
1	MDI0+	2	MDI0+
3	MDI1+	4	MDI1-
5	NC	6	NC
7	MDI2+	8	MDI2-
9	MDI3+	10	MDI3-

**Table 3-26: LAN Pinouts**

The RJ-45 Ethernet connector has two status LEDs, one green and one yellow. The green LED indicates activity on the port and the yellow LED indicates the speed. See **Table 3-27**.

Speed LED		Activity/Link LED	
STATUS	DESCRIPTION	STATUS	DESCRIPTION
Off	10 Mbps connection	Off	No link
Green	100 Mbps connection	Yellow	Linked
Orange	Gbps connection	Blinking	TX/RX activity 1

**Table 3-27: RJ-45 Ethernet Connector LEDs**



**Figure 3-26: RJ-45 Ethernet Connector**

### 3.3.2 HDMI Connectors

- CN Label:** HDMI1, HDMI2
- CN Type:** HDMI type A connector
- CN Location:** See **Figure 3-25**
- CN Pinouts:** See **Table 3-28**

The HDMI (High-Definition Multimedia Interface) connector connects to digital audio or video sources.

Pin	Description	Pin	Description
1	HDMI_DATA2	13	N/C
2	GND	14	N/C
3	HDMI_DATA2#	15	HDMI_SCL
4	HDMI_DATA1	16	HDMI_SDA
5	GND	17	GND
6	HDMI_DATA1#	18	+5V
7	HDMI_DATA0	19	HDMI_HPD
8	GND	20	HDMI_GND
9	HDMI_DATA0#	21	HDMI_GND
10	HDMI_CLK	22	HDMI_GND
11	GND	23	HDMI_GND
12	HDMI_CLK#		

**Table 3-28: HDMI Connector Pinouts**

Chapter

4

# Installation

---

## 4.1 Anti-static Precautions

---



### WARNING:

Failure to take ESD precautions during the installation of the NOVA-HM551 may result in permanent damage to the NOVA-HM551 and severe injury to the user.

---

Electrostatic discharge (ESD) can cause serious damage to electronic components, including the NOVA-HM551. Dry climates are especially susceptible to ESD. It is therefore critical that whenever the NOVA-HM551 or any other electrical component is handled, the following anti-static precautions are strictly adhered to.

- **Wear an anti-static wristband:** Wearing a simple anti-static wristband can help to prevent ESD from damaging the board.
- **Self-grounding:** Before handling the board, touch any grounded conducting material. During the time the board is handled, frequently touch any conducting materials that are connected to the ground.
- **Use an anti-static pad:** When configuring the NOVA-HM551, place it on an anti-static pad. This reduces the possibility of ESD damaging the NOVA-HM551.
- **Only handle the edges of the PCB:** When handling the PCB, hold the PCB by the edges.

## 4.2 Installation Considerations

---



### NOTE:

The following installation notices and installation considerations should be read and understood before the NOVA-HM551 is installed. All installation notices pertaining to the installation of the NOVA-HM551 should be strictly adhered to. Failing to adhere to these precautions may lead to severe damage of the NOVA-HM551 and injury to the person installing the motherboard.

---

### 4.2.1 Installation Notices

---



### WARNING:

The installation instructions described in this manual should be carefully followed in order to prevent damage to the NOVA-HM551, NOVA-HM551 components and injury to the user.

---

Before and during the installation please **DO** the following:

- Read the user manual:
  - The user manual provides a complete description of the NOVA-HM551 installation instructions and configuration options.
- Wear an electrostatic discharge cuff (ESD):
  - Electronic components are easily damaged by ESD. Wearing an ESD cuff removes ESD from the body and helps prevent ESD damage.
- Place the NOVA-HM551 on an antistatic pad:
  - When installing or configuring the motherboard, place it on an antistatic pad. This helps to prevent potential ESD damage.
- Turn all power to the NOVA-HM551 off:

- When working with the NOVA-HM551, make sure that it is disconnected from all power supplies and that no electricity is being fed into the system.

Before and during the installation of the NOVA-HM551 **DO NOT:**

- Remove any of the stickers on the PCB board. These stickers are required for warranty validation.
- Use the product before verifying all the cables and power connectors are properly connected.
- Allow screws to come in contact with the PCB circuit, connector pins, or its components.

### 4.3 Unpacking

When the NOVA-HM551 is unpacked, please check all the unpacking list items listed in Chapter 3 are indeed present. If any of the unpacking list items are not available please contact the NOVA-HM551 vendor reseller/vendor where the NOVA-HM551 was purchased or contact an IEI sales representative.

### 4.4 CPU, CPU Cooling Kit and SO-DIMM Installation



#### **WARNING:**

A CPU should never be turned on without the specified cooling kit being installed. If the cooling kit (heat sink and fan) is not properly installed and the system turned on, permanent damage to the CPU, NOVA-HM551 and other electronic components attached to the system may be incurred. Running a CPU without a cooling kit may also result in injury to the user.

The CPU, CPU cooling kit and DIMM are the most critical components of the NOVA-HM551. If one of these component is not installed the NOVA-HM551 cannot run.

## NOVA-HM551 5.25" SBC

### 4.4.1 Socket G1 CPU Installation

---

**WARNING:**

CPUs are expensive and sensitive components. When installing the CPU please be careful not to damage it in anyway. Make sure the CPU is installed properly and ensure the correct cooling kit is properly installed.

---

To install a socket G1 CPU onto the NOVA-HM551, follow the steps below:

---

**WARNING:**

When handling the CPU, only hold it on the sides. DO NOT touch the pins at the bottom of the CPU.

---

**Step 1: Unlock the CPU retention screw.** When shipped, the retention screw of the CPU socket should be in the unlocked position. If it is not in the unlocked position, use a screwdriver to unlock the screw. See **Figure 4-1**.

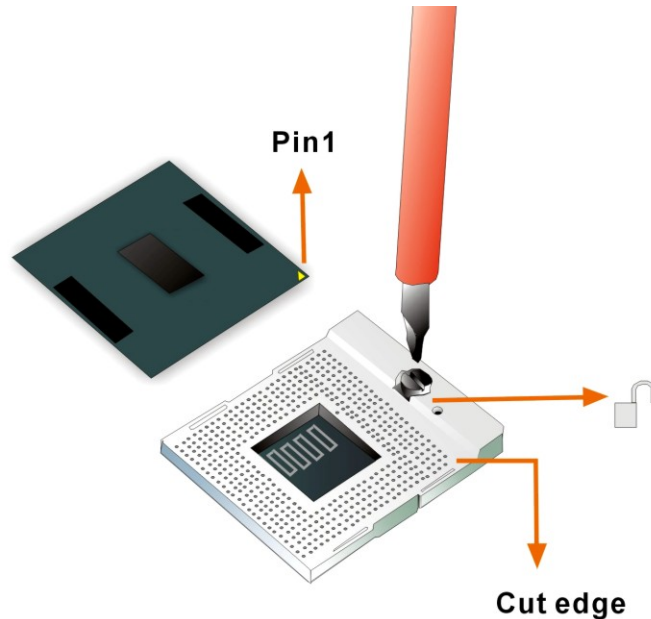

**Figure 4-1: Make sure the CPU socket retention screw is unlocked**

- Step 2: Inspect the CPU socket.** Make sure there are no bent pins and make sure the socket contacts are free of foreign material. If any debris is found, remove it with compressed air.
- Step 3: Correctly Orientate the CPU.** Make sure the IHS (integrated heat sink) side is facing upwards.
- Step 4: Correctly position the CPU.** Match the Pin 1 mark with the cut edge on the CPU socket. See **Figure 4-1**.
- Step 5: Align the CPU pins.** Carefully align the CPU pins with the holes in the CPU socket.
- Step 6: Insert the CPU.** Gently insert the CPU into the socket. If the CPU pins are properly aligned, the CPU should slide into the CPU socket smoothly.
- Step 7: Lock the retention screw.** Rotate the retention screw into the locked position. See **Figure 4-2**.



## NOVA-HM551 5.25" SBC

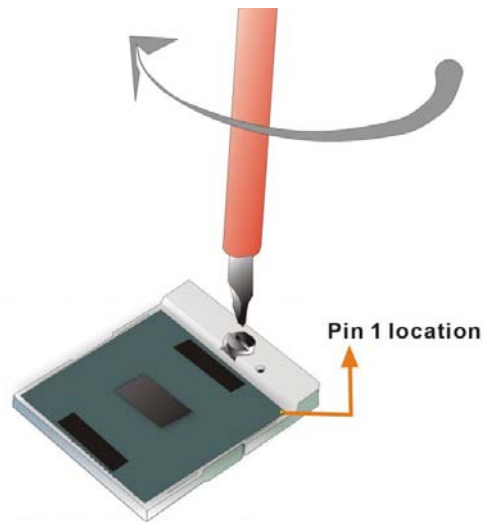

Figure 4-2: Lock the CPU Socket Retention Screw

#### 4.4.2 Socket G1 Cooling Kit Installation

An IEI Socket G1 CPU cooling kit can be purchased separately. (See **Chapter 3**) The cooling kit comprises a CPU heat sink and a cooling fan.



**WARNING:**

Do not wipe off (accidentally or otherwise) the pre-sprayed layer of thermal paste on the bottom of the heat sink. The thermal paste between the CPU and the heat sink is important for optimum heat dissipation.

To install the cooling kit, please follow the steps below.

**Step 1: Install the cooling kit bracket.** A cooling kit bracket is installed on the rear of the motherboard. Align the bracket with the four retention holes at the back of the motherboard. Once properly aligned, insert four retention screws from the front of the motherboard.

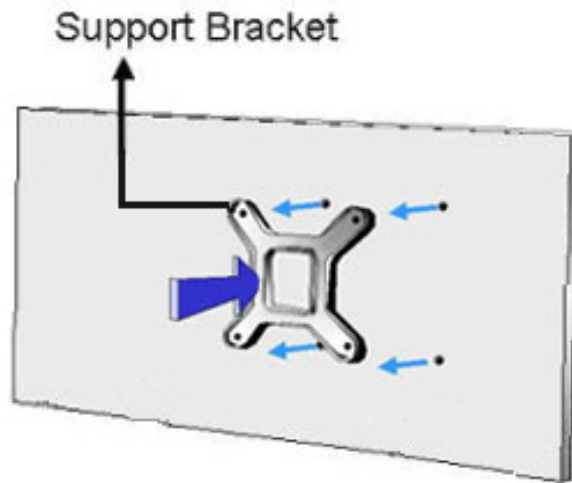

Figure 4-3: Cooling Kit Support Bracket

- Step 2:** **Open the lever at the top of the heat sink.** Lift the lever at the top of the cooling kit to loosen the cooling kit clamps.
- Step 3:** **Secure the cooling kit.** Gently place the heat sink and cooling kit onto the CPU. Make sure the hooks are properly secured to the bracket. To secure the cooling kit, close the top lever.
- Step 4:** **Connect the fan cable.** Connect the cooling kit fan cable to the fan connector on the NOVA-HM551. Carefully route the cable and avoid heat generating chips and fan blades.

## NOVA-HM551 5.25" SBC

### 4.4.3 SO-DIMM Installation

To install an SO-DIMM, please follow the steps below and refer to **Figure 4-4**.

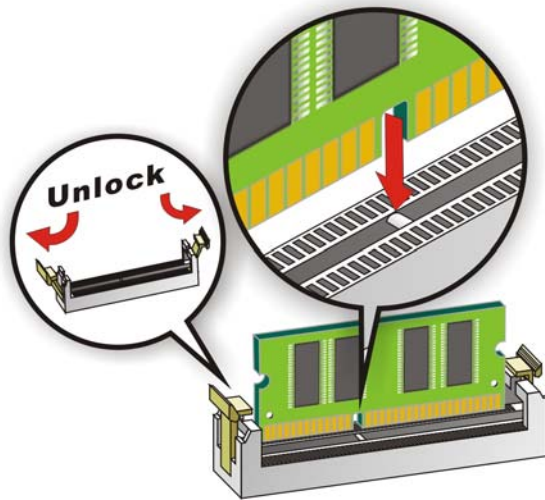

**Figure 4-4: SO-DIMM Installation**

- Step 1:** **Open the SO-DIMM socket handles.** Open the two handles outwards as far as they can. See **Figure 4-4**.
- Step 2:** **Align the SO-DIMM with the socket.** Align the SO-DIMM so the notch on the memory lines up with the notch on the memory socket. See **Figure 4-4**.
- Step 3:** **Insert the SO-DIMM.** Once aligned, press down until the SO-DIMM is properly seated. Clip the two handles into place. See **Figure 4-4**.
- Step 4:** **Removing a SO-DIMM.** To remove a SO-DIMM, push both handles outward. The memory module is ejected by a mechanism in the socket.

## 4.5 Jumper Settings



### NOTE:

A jumper is a metal bridge used to close an electrical circuit. It consists of two or three metal pins and a small metal clip (often protected by a plastic cover) that slides over the pins to connect them. To CLOSE/SHORT a jumper means connecting the pins of the jumper with the plastic clip and to OPEN a jumper means removing the plastic clip from a jumper.

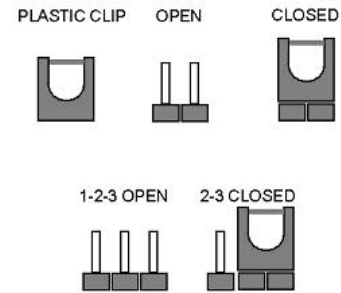

**Figure 4-5: Jumper Locations**

Before the NOVA-HM551 is installed in the system, the jumpers must be set in accordance with the desired configuration. The jumpers on the NOVA-HM551 are listed in **Table 4-1**.

Description	Type	Label
AT/ATX power mode setting	3-pin header	J_ATXCTL1
Clear CMOS	3-pin header	J_CMOS1
COM5 RS-232/422/485 select	8-pin header	JP4
COM6 RS-232/422/485 select	8-pin header	JP5
LVDS LCD voltage select	3-pin header	J_VLVDS1
LVDS panel resolution select	8-pin header	J_PID1
PCI-104 and VIO voltage select	3-pin header	JP6

**Table 4-1: Jumpers**

## NOVA-HM551 5.25" SBC

### 4.5.1 AT/ATX Power Select

<b>Jumper Label:</b>	<b>J_ATXCTL1</b>
<b>Jumper Type:</b>	3-pin header (1x3)
<b>Jumper Settings:</b>	See <b>Table 4-2</b>
<b>Jumper Location:</b>	See <b>Figure 4-6</b>

The AT/ATX Power Select jumper specifies the systems power mode as AT or ATX. AT/ATX Power Select jumper settings are shown in **Table 4-2**.

Setting	Description
Short 1 - 2	Use ATX power (Default)
Short 2 - 3	Use AT power

**Table 4-2: AT/ATX Power Select Jumper Settings**

The location of the AT/ATX Power Select jumper is shown in **Figure 4-6** below.

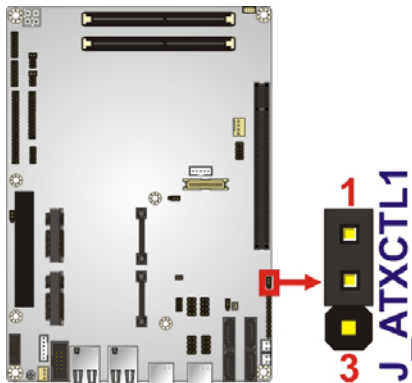

**Figure 4-6: AT/ATX Power Select Jumper Location**

### 4.5.2 Clear CMOS

<b>Jumper Label:</b>	<b>J_CMOS1</b>
<b>Jumper Type:</b>	3-pin header (1x3)
<b>Jumper Settings:</b>	See <b>Table 4-3</b>

**Jumper Location:** See **Figure 4-7**

If the NOVA-HM551 fails to boot due to improper BIOS settings, the clear CMOS jumper clears the CMOS data and resets the system BIOS information. To do this, use the jumper cap to close pins 2 and 3 for a few seconds then reinstall the jumper clip back to pins 1 and 2.

If the “CMOS Settings Wrong” message is displayed during the boot up process, the fault may be corrected by pressing the F1 to enter the CMOS Setup menu. Do one of the following:

- Enter the correct CMOS setting
- Load Optimal Defaults
- Load Failsafe Defaults.

After having done one of the above, save the changes and exit the CMOS Setup menu.

The clear CMOS jumper settings are shown in **Table 4-3**.

Setting	Description
Short 1 - 2	Keep CMOS Setup (Default)
Short 2 - 3	Clear CMOS Setup

**Table 4-3: Clear CMOS Jumper Settings**

The location of the clear CMOS jumper is shown in **Figure 4-7** below.

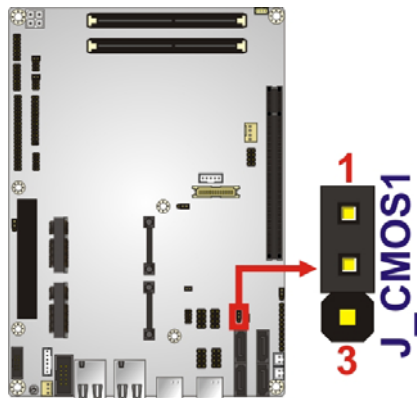

**Figure 4-7: Clear CMOS Jumper**

## NOVA-HM551 5.25" SBC

### 4.5.3 COM 5 Function Select

<b>Jumper Label:</b>	<b>JP4</b>
<b>Jumper Type:</b>	8-pin header
<b>Jumper Settings:</b>	See <b>Table 4-4</b>
<b>Jumper Location:</b>	See <b>Figure 4-8</b>

The COM 5 Function Select jumper sets the communication protocol used by the third serial communications port (COM 5) as RS-232, RS-422 or RS-485. The COM 5 Function Select settings are shown in the table below.

Setting	Description
Short 1-2	RS-232 (Default)
Short 3-4	RS-422
Short 5-6	RS-485
Short 5-6, 7-8	RS-485 with RTS control

**Table 4-4: COM 5 Function Select Jumper Settings**

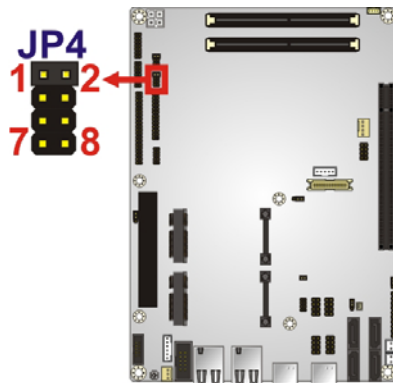

**Figure 4-8: COM 5 Function Select Jumper Location**

### 4.5.4 COM 6 Function Select

<b>Jumper Label:</b>	<b>JP5</b>
<b>Jumper Type:</b>	8-pin header
<b>Jumper Settings:</b>	See <b>Table 4-5</b>
<b>Jumper Location:</b>	See <b>Figure 4-9</b>

The COM 6 Function Select jumper sets the communication protocol used by the third serial communications port (COM 6) as RS-232, RS-422 or RS-485. The COM 6 Function Select settings are shown in the table below.

Setting	Description
Short 1-2	RS-232 (Default)
Short 3-4	RS-422
Short 5-6	RS-485
Short 5-6, 7-8	RS-485 with RTS control

**Table 4-5: COM 6 Function Select Jumper Settings**

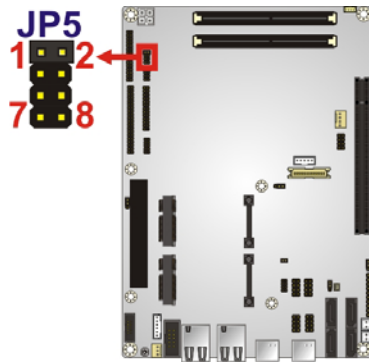

**Figure 4-9: COM 6 Function Select Jumper Location**

#### 4.5.5 LVDS Voltage Select



**WARNING:**

Incorrect voltages can destroy the LCD panel. Make sure to select a voltage that matches the voltage required by the LCD panel.

- Jumper Label:** J\_VLVDS1
- Jumper Type:** 3-pin header
- Jumper Settings:** See Table 4-6
- Jumper Location:** See Figure 4-10



## NOVA-HM551 5.25" SBC

The LCD voltage selection jumper sets the voltage of the power supplied to the LCD panel.

Setting	Description
Short 1-2	+3.3 V (Default)
Short 2-3	+5.0 V

**Table 4-6: LVDS Voltage Selection Jumper Settings**

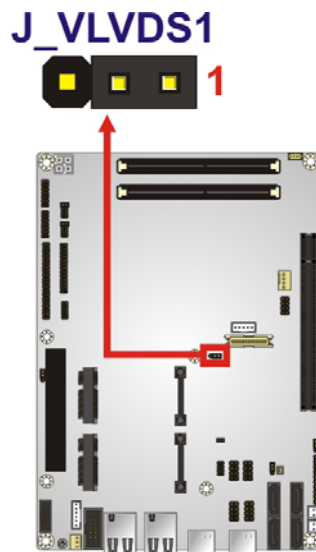

**Figure 4-10: LVDS Voltage Selection Jumper Locations**

### 4.5.6 LVDS Panel Resolution Select

<b>Jumper Label:</b>	<b>J_PID1</b>
<b>Jumper Type:</b>	8-pin header
<b>Jumper Settings:</b>	See <b>Table 4-7</b>
<b>Jumper Location:</b>	See <b>Figure 4-11</b>

The LVDS Panel Resolution jumper configures the resolution of the LVDS output. The LVDS Panel Resolution jumper settings are shown in Table 4-6.

Setting	Description
OFF	640 X 480 (18-bit)
Short 1-2	800 X 600 (18-bit) (Default)

Setting	Description
Short 3-4	1024 X 768 (18-bit)
Short 1-2, 3-4	1024 X 768 (24-bit)
Short 5-6	1024 X 768 (48-bit)
Short 1-2, 5-6	1280 X 1024 (48-bit)
Short 3-4, 5-6	1600 X 1200 (48-bit)
Short 1-2, 3-4, 5-6	1280 X 768 (18-bit)
Short 7-8	1280 X 800 (18-bit)
Short 1-2, 7-8	1366 X 768 (24-bit)
Short 3-4, 7-8	1440 X 900 (36-bit)
Short 1-2, 3-4, 7-8	1440 X 900 (48-bit)
Short 5-6, 7-8	1680 X 1050 (48-bit)
Short 1-2, 5-6, 7-8	1920 X 1080 (48-bit)
Short 3-4, 5-6, 7-8	1920 X 1200 (48-bit)

**Table 4-7: LVDS1 Panel Resolution Jumper Setting**

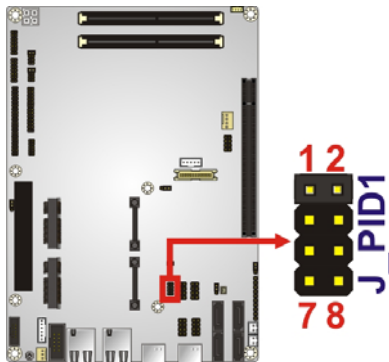

**Figure 4-11:LVDS Panel Resolution Jumper Pinout Locations**

#### 4.5.7 PCI-104 Voltage Setup

- Jumper Label:** JP6
- Jumper Type:** 3-pin header
- Jumper Settings:** See Table 4-8
- Jumper Location:** See Figure 4-12

## NOVA-HM551 5.25" SBC

This jumper selects the voltage supplied to the PCI-104 expansion module.

Setting	Description
Short 1-2	+5.0 V (Default)
Short 2-3	+3.3 V

**Table 4-8: PCI-104 Voltage Jumper Settings**

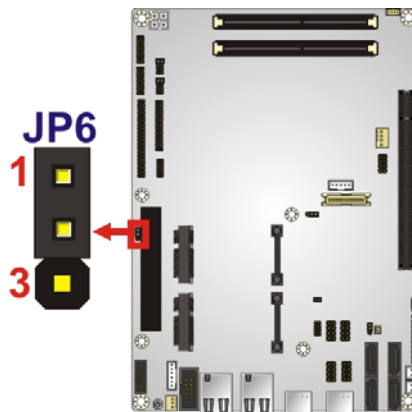

**Figure 4-12: PCI-104 Voltage Jumper Location**

## 4.6 Chassis Installation

### 4.6.1 Airflow



#### **WARNING:**

Airflow is critical to the cooling of the CPU and other onboard components. The chassis in which the NOVA-HM551 must have air vents to allow cool air to move into the system and hot air to move out.

The NOVA-HM551 must be installed in a chassis with ventilation holes on the sides allowing airflow to travel through the heat sink surface. In a system with an individual power supply unit, the cooling fan of a power supply can also help generate airflow through the board surface.

## 4.6.2 Motherboard Installation

To install the NOVA-HM551 motherboard into the chassis please refer to the reference material that came with the chassis.

## 4.7 Internal Peripheral Device Connections

This section outlines the installation of peripheral devices to the onboard connectors

### 4.7.1 Audio Kit Installation

The Audio Kit that came with the NOVA-HM551 connects to the audio connector on the NOVA-HM551. The audio kit consists of three audio jacks. Mic-in connects to a microphone. Line-in provides a stereo line-level input to connect to the output of an audio device. Line-out, a stereo line-level output, connects to two amplified speakers. To install the audio kit, please refer to the steps below:

**Step 1: Locate the audio connector.** The location of the 10-pin audio connector is shown in **Chapter 3**.

**Step 2: Align pin 1.** Align pin 1 on the on-board connector with pin 1 on the audio kit connector. Pin 1 on the audio kit connector is indicated with a white dot. See Figure 4-13.

## NOVA-HM551 5.25" SBC

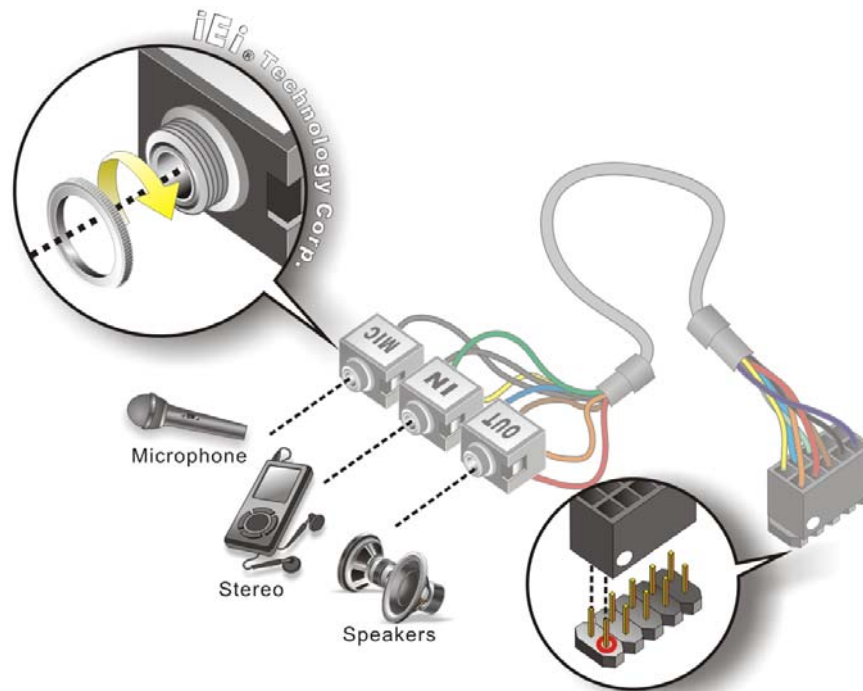

**Figure 4-13: Audio Kit Cable Connection**

**Step 3: Connect the audio devices.** Connect speakers to the line-out audio jack. Connect the output of an audio device to the line-in audio jack. Connect a microphone to the mic-in audio jack.

#### 4.7.2 Keyboard/Mouse Connector

The NOVA-HM551 is shipped with a keyboard/mouse Y-cable connector. The keyboard/mouse Y-cable connector connects to a keyboard/mouse connector on the NOVA-HM551 and branches into two cables that are each connected to a PS/2 connector, one for a mouse and one for a keyboard. To connect the keyboard/mouse Y-cable connector, please follow the steps below.

**Step 1: Locate the connector.** The location of the keyboard/mouse Y-cable connector is shown in **Chapter 3**.

**Step 2: Align the connectors.** Correctly align pin 1 on the cable connector with pin 1 on the NOVA-HM551 keyboard/mouse connector. See Figure 4-14.

**Step 3:** **Insert the cable connectors** Once the cable connector is properly aligned with the keyboard/mouse connector on the NOVA-HM551, connect the cable connector to the on-board connectors. See Figure 4-14.

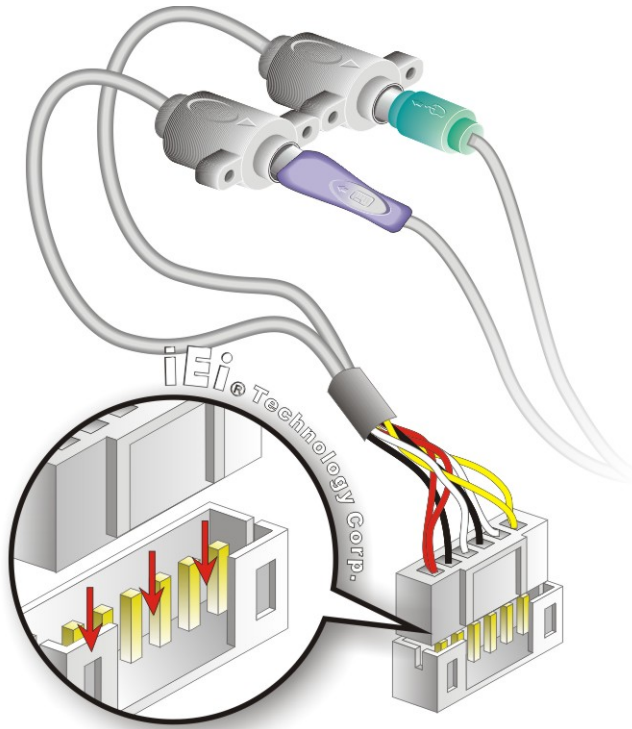

**Figure 4-14: Keyboard/mouse Y-cable Connection**

**Step 4:** **Attach PS/2 connectors to the chassis.** The keyboard/mouse Y-cable connector is connected to two PS/2 connectors. To secure the PS/2 connectors to the chassis please refer to the installation instructions that came with the chassis.

**Step 5:** **Connect the keyboard and mouse.** Once the PS/2 connectors are connected to the chassis, a keyboard and mouse can each be connected to one of the PS/2 connectors. The keyboard PS/2 connector and mouse PS/2 connector are both marked. Please make sure the keyboard and mouse are connected to the correct PS/2 connector.

## NOVA-HM551 5.25" SBC

### 4.7.3 PCIe Mini Card Installation

To install the PCIe Mini card, please refer to the diagram and instructions below.

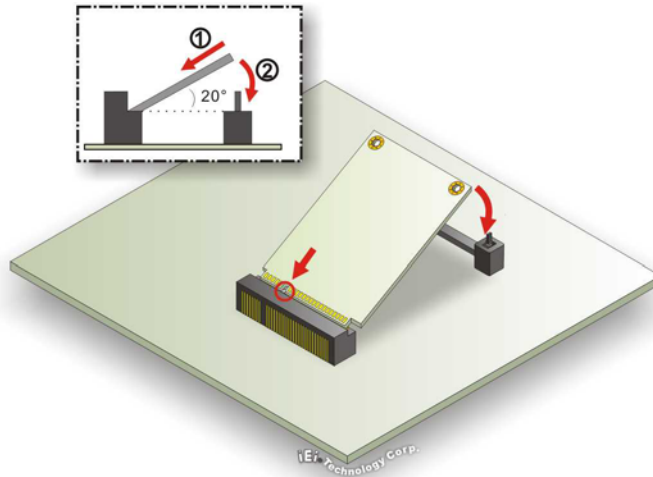

**Figure 4-15: PCIe Mini Card Installation**

- Step 1:** **Insert into the socket at an angle.** Line up the notch on the card with the notch on the connector. Slide the PCIe Mini card into the socket at an angle of about 20°.
- Step 2:** **Push down until the card clips into place.** Push the other end of the card down until it clips into place on the plastic connector.

### 4.7.4 SATA Drive Connection

The NOVA-HM551 is shipped with two SATA drive cables. To connect the SATA drives to the connectors, please follow the steps below.

- Step 1:** **Locate the connectors.** The locations of the SATA drive connectors are shown in **Chapter 3**.
- Step 2:** **Insert the cable connector.** Press the clip on the connector at the end of the SATA cable and insert the cable connector into the on-board SATA drive connector. See Figure 4-16.

**Step 3:** Connect the **SATA power cable**. Connect the SATA power connector into the on-board SATA power connector. See Figure 4-16.

**Step 4:** Connect the cable to the **SATA disk**. Connect the connector on the other end of the cable to the connector at the back of the SATA drive. See Figure 4-16.

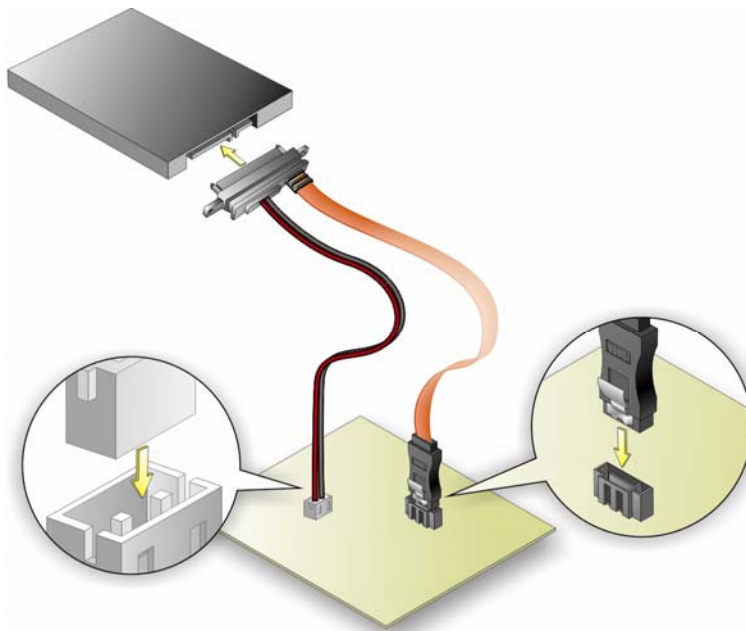

Figure 4-16: SATA Drive Connection

#### 4.7.5 Four Serial Port Connector

The 40-pin serial port connector connects the board connector to four DB-9 connectors. To install, please follow the steps below.

**Step 1:** **Locate the COM connector.** The locations of the COM port connectors are shown in Chapter 4.

**Step 2:** **Insert the cable connector.** Align the cable connector with the onboard connector. Make sure pin 1 on the board and connector line up.



## NOVA-HM551 5.25" SBC

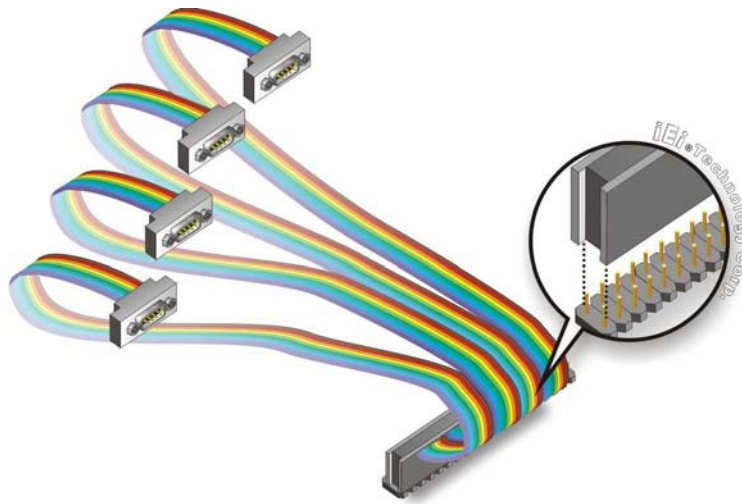

Figure 4-17: Four Serial Port Connector

**Step 3:** Secure the serial ports to the chassis. Tighten the screws on the DB-9 connectors to secure them to the chassis.

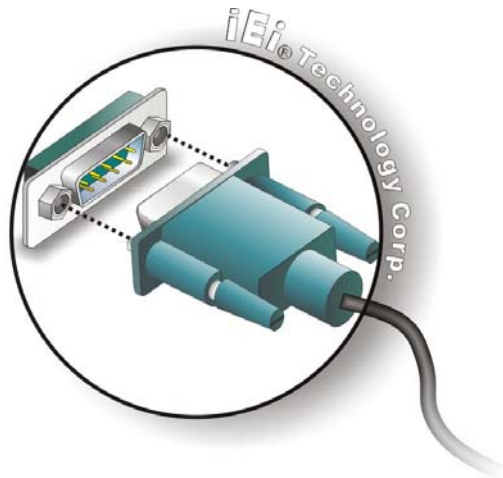

Figure 4-18: Serial Device Connector

#### 4.7.6 USB Cable

The NOVA-HM551 is shipped with a dual port USB 2.0 cable. To connect the USB cable connector, please follow the steps below.

**Step 1:** Locate the connectors. The locations of the USB connectors are shown in Chapter 3.

**WARNING:**

If the USB pins are not properly aligned, the USB device can burn out.

**Step 2: Align the connectors.** The cable has two connectors. Correctly align pin 1 on each cable connector with pin 1 on the NOVA-HM551 USB connector.

**Step 3: Insert the cable connectors.** Once the cable connectors are properly aligned with the USB connectors on the NOVA-HM551, connect the cable connectors to the on-board connectors. See Figure 4-19.

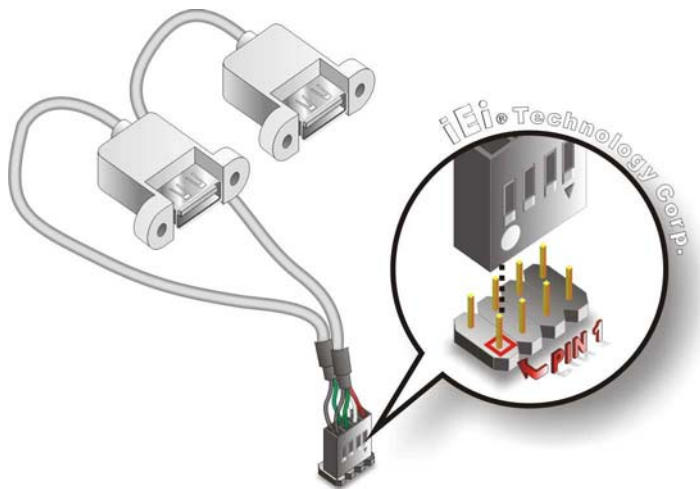

**Figure 4-19: Dual USB Cable Connection**

**Step 4: Attach the USB connectors to the chassis.** The USB 2.0 connectors each of two retention screw holes. To secure the connectors to the chassis please refer to the installation instructions that came with the chassis.

## 4.8 External Peripheral Interface Connection

The following external peripheral devices can be connected to the external peripheral interface connectors.

- HDMI devices
- RJ-45 Ethernet cable connector

To install these devices, connect the corresponding cable connector from the actual device to the corresponding NOVA-HM551 external peripheral interface connector making sure the pins are properly aligned.

### 4.8.1 HDMI Display Device Connection

The HDMI connector transmits a digital signal to compatible HDMI display devices such as a TV or computer screen. To connect the HDMI cable to the NOVA-HM551, follow the steps below.

**Step 1:** **Locate the HDMI connector.** The location is shown in Chapter 3.

**Step 2:** **Align the connector.** Align the HDMI connector with the HDMI port. Make sure the orientation of the connector is correct.

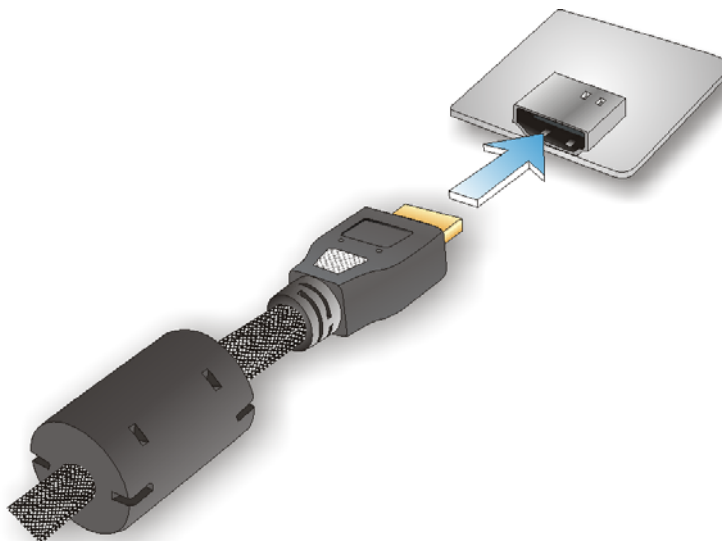

Figure 4-20: HDMI Connection

**Step 3: Insert the HDMI connector.** Gently insert the HDMI connector. The connector should engage with a gentle push. If the connector does not insert easily, check again that the connector is aligned correctly, and that the connector is being inserted with the right way up.

#### 4.8.2 LAN Connection

There are two external RJ-45 LAN connectors. The RJ-45 connector enables connection to an external network. To connect a LAN cable with an RJ-45 connector, please follow the instructions below.

**Step 1: Locate the RJ-45 connectors.** The locations of the LAN connector are shown in **Chapter 4**.

**Step 2: Align the connectors.** Align the RJ-45 connector on the LAN cable with one of the RJ-45 connectors on the NOVA-HM551. See Figure 4-21.

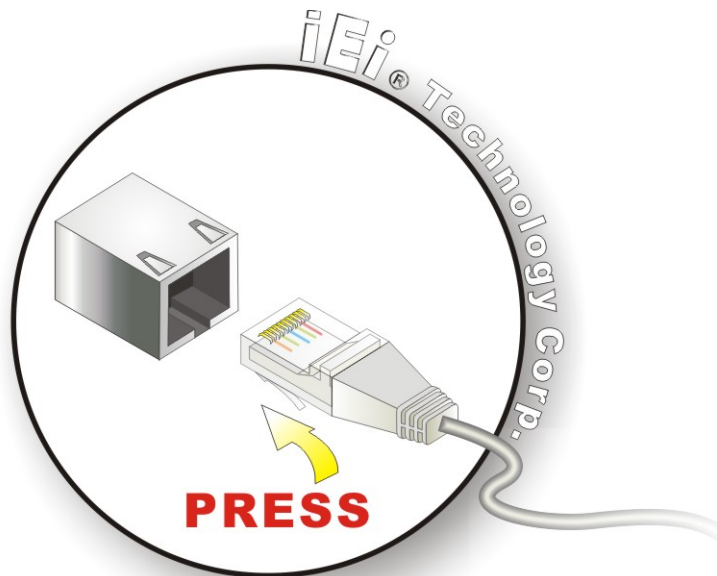

Figure 4-21: LAN Connection

**Step 3: Insert the LAN cable RJ-45 connector.** Once aligned, gently insert the LAN cable RJ-45 connector into the on-board RJ-45 connector.

## NOVA-HM551 5.25" SBC

### 4.9 Software Installation

All the drivers for the NOVA-HM551 are on the CD that came with the system. To install the drivers, please follow the steps below.

**Step 1:** Insert the CD into a CD drive connected to the system.



#### NOTE:

If the installation program doesn't start automatically:  
Click "Start->My Computer->CD Drive->autorun.exe"

**Step 2:** The driver main menu appears (**Figure 4-22**).

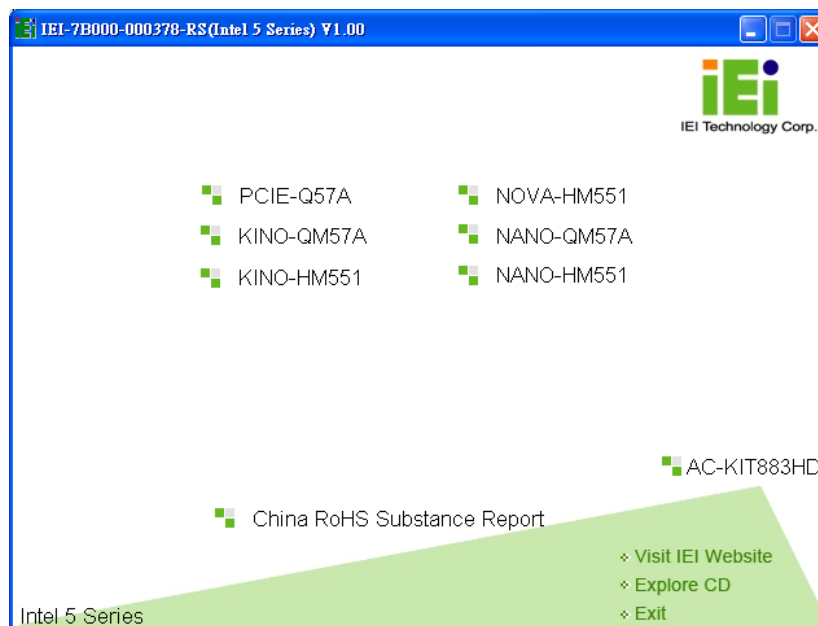

**Figure 4-22: Introduction Screen**

**Step 3:** Click **NOVA-HM551**.

**Step 4:** A new screen with a list of available drivers appears (**Figure 4-23**).



**Figure 4-23: Available Drivers**

**Step 5:** Install all of the necessary drivers in this menu.

Chapter

5

# BIOS Screens

---

## 5.1 Introduction

The BIOS is programmed onto the BIOS chip. The BIOS setup program allows changes to certain system settings. This chapter outlines the options that can be changed.

### 5.1.1 Starting Setup

The UEFI BIOS is activated when the computer is turned on. The setup program can be activated in one of two ways.

1. Press the **F2** key as soon as the system is turned on or
2. Press the **F2** key when the “**Press F2 to enter SETUP**” message appears on the screen.

If the message disappears before the **F2** key is pressed, restart the computer and try again.

### 5.1.2 Using Setup

Use the arrow keys to highlight items, press **ENTER** to select, use the PageUp and PageDown keys to change entries, press **F1** for help and press **ESC** to quit. Navigation keys are shown in.

Key	Function
Up arrow	Move to the item above
Down arrow	Move to the item below
Left arrow	Move to the item on the left hand side
Right arrow	Move to the item on the right hand side
+	Increase the numeric value or make changes
-	Decrease the numeric value or make changes
Page up	Move to the next page
Page down	Move to the previous page



Key	Function
Esc	Main Menu – Quit and do not save changes into CMOS Status Page Setup Menu and Option Page Setup Menu -- Exit current page and return to Main Menu
F1	General help, only for Status Page Setup Menu and Option Page Setup Menu
F9	Load optimized defaults
F10	Save changes and Exit BIOS

**Table 5-1: BIOS Navigation Keys**

### 5.1.3 Getting Help

When **F1** is pressed a small help window describing the appropriate keys to use and the possible selections for the highlighted item appears. To exit the Help Window press **Esc** or the **F1** key again.

### 5.1.4 Unable to Reboot After Configuration Changes

If the computer cannot boot after changes to the system configuration is made, CMOS defaults. Use the jumper described in Chapter 5.

### 5.1.5 BIOS Menu Bar

The **menu bar** on top of the BIOS screen has the following main items:

- Main – Changes the basic system configuration.
- Advanced – Changes the advanced system settings.
- Chipset – Changes the chipset settings.
- Boot – Changes the system boot configuration.
- Security – Sets User and Supervisor Passwords.
- Save & Exit – Selects exit options and loads default settings

The following sections completely describe the configuration options found in the menu items at the top of the BIOS screen and listed above.

## 5.2 Main

The **Main** BIOS menu (**BIOS Menu 1**) appears when the **BIOS Setup** program is entered. The **Main** menu gives an overview of the basic system information.

Aptio Setup Utility - Copyright (C) 2010 American Megatrends, Inc.					
Main	Advanced	Chipset	Boot	Security	Save & Exit
BIOS Information					Set the Time. Use Tab to switch between Time elements.
BIOS Vendor			American Megatrends		
Core Version			4.6.3.7 0.16		
Project Version			E349AR10.ROM		
Build Date			12/28/2010 16:23:19		
-----					
Memory Information					←→: Select Screen
Total Memory			2048 MB (DDR3 1333)		↑ ↓: Select Item
System Date			[Tue 08/18/2008]		EnterSelect
System Time			[14:20:27]		F1 General Help
Access Level			Administrator		F2 Previous Values
					F3 Optimized Defaults
					F4 Save
					ESC Exit
Version 2.10.1208. Copyright (C) 2010 American Megatrends, Inc.					

### BIOS Menu 1: Main

#### → BIOS Information

The **BIOS Information** lists a brief summary of the BIOS. The fields in **BIOS Information** cannot be changed. The items shown in the system overview include:

- **BIOS Vendor:** Installed BIOS vendor
- **Core Version:** Current BIOS version
- **Project Version:** the board version
- **Build Date:** Date the current BIOS version was made

#### → Memory Information

The **Memory Information** lists a brief summary of the on-board memory. The fields in **Memory Information** cannot be changed.

- **Total Memory:** Displays the auto-detected system memory size and type.

The System Overview field also has two user configurable fields:

## NOVA-HM551 5.25" SBC

### → System Date [xx/xx/xx]

Use the **System Date** option to set the system date. Manually enter the day, month and year.

### → System Time [xx:xx:xx]

Use the **System Time** option to set the system time. Manually enter the hours, minutes and seconds.

## 5.3 Advanced

Use the **Advanced** menu (**BIOS Menu 2**) to configure the CPU and peripheral devices through the following sub-menus:



### WARNING!

Setting the wrong values in the sections below may cause the system to malfunction. Make sure that the settings made are compatible with the hardware.

```

Aptio Setup Utility - Copyright (C) 2010 American Megatrends, Inc.
Main  Advanced  Chipset  Boot  Security  Save & Exit
-----
> ACPI Settings
> Trusted Computing
> CPU Configuration
> SATA Configuration
> USB Configuration
> Super IO Configuration
> H/M Monitor
> Serial Port Console Redirection

System ACPI Parameters
-----
<=>: Select Screen
↑ ↓: Select Item
Enter>Select
F1  General Help
F2  Previous Values
F3  Optimized
Defaults
F4  Save
ESC Exit

Version 2.10.1208. Copyright (C) 2010 American Megatrends, Inc.
    
```

### BIOS Menu 2: Advanced

### 5.3.1 ACPI Configuration

The **ACPI Configuration** menu (**BIOS Menu 3**) configures the Advanced Configuration and Power Interface (ACPI) options.

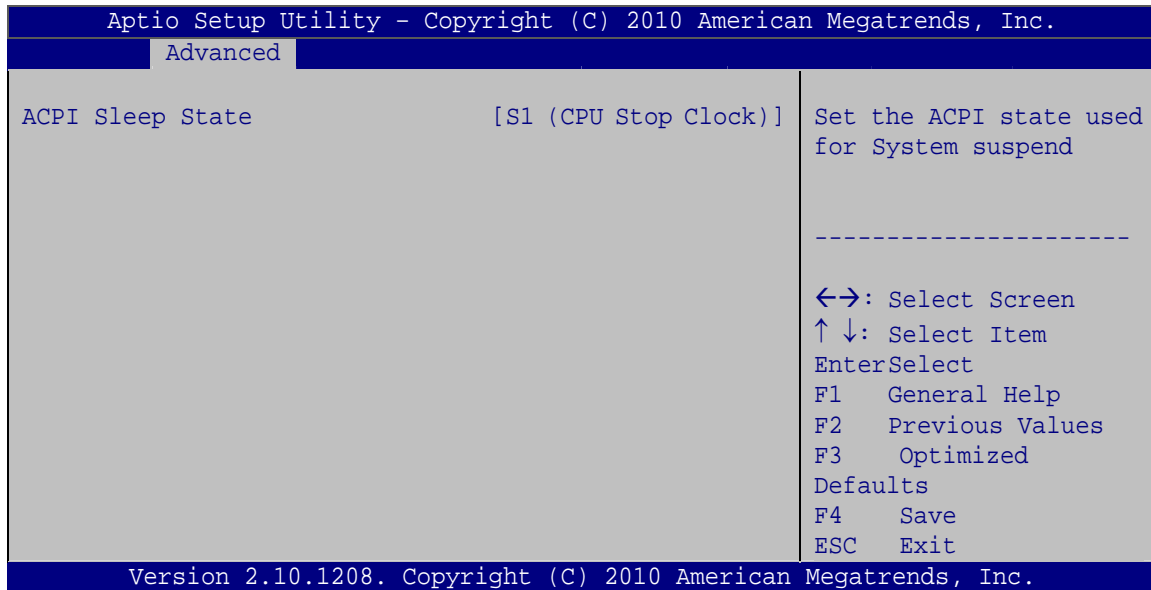

#### BIOS Menu 3: ACPI Configuration

##### → ACPI Sleep State [S1 (CPU Stop Clock)]

Use the **ACPI Sleep State** option to specify the sleep state the system enters when it is not being used.

- **S1 (CPU Stop Clock)** **DEFAULT** The system enters S1(POS) sleep state. The system appears off. The CPU is stopped; RAM is refreshed; the system is running in a low power mode.
- **S3 (Suspend to RAM)** The caches are flushed and the CPU is powered off. Power to the RAM is maintained. The computer returns slower to a working state, but more power is saved.

## NOVA-HM551 5.25" SBC

### 5.3.2 Trusted Computing

Use the **Trusted Computing** menu (**BIOS Menu 4**) to configure settings related to the Trusted Computing Group (TCG) Trusted Platform Module (TPM).

```

Aptio Setup Utility - Copyright (C) 2010 American Megatrends, Inc.
  Advanced
-----
TPM Configuration
  TPM SUPPORT                [Enable]
  TPM State                   [Disabled]
  Pending TPM operation       [None]

Current TPM Status Information
  TPM Enabled Status:         [Disable]
  TPM Active Status:         [Deactivated]
  TPM Owner Status:          [Unowned]

-----
<->: Select Screen
↑ ↓: Select Item
Enter>Select
F1   General Help
F2   Previous Values
F3   Optimized
Defaults
F4   Save
ESC  Exit

Version 2.10.1208. Copyright (C) 2010 American Megatrends, Inc.
  
```

#### BIOS Menu 4: TPM Configuration

##### → TPM Support [Enable]

Use the **TPM Support** option to configure support for the TPM.

- **Disable**                    TPM support is disabled.
- **Enable**    **DEFAULT**    TPM support is enabled.

##### → TPM State [Disabled]

Use the **TPM State** option to configure the TPM state.

- **Disabled**    **DEFAULT**    TPM is disabled.
- **Enabled**                    TPM is enabled.

### 5.3.3 CPU Configuration

Use the **CPU Configuration** menu (**BIOS Menu 5**) to view detailed CPU specifications and configure the CPU.

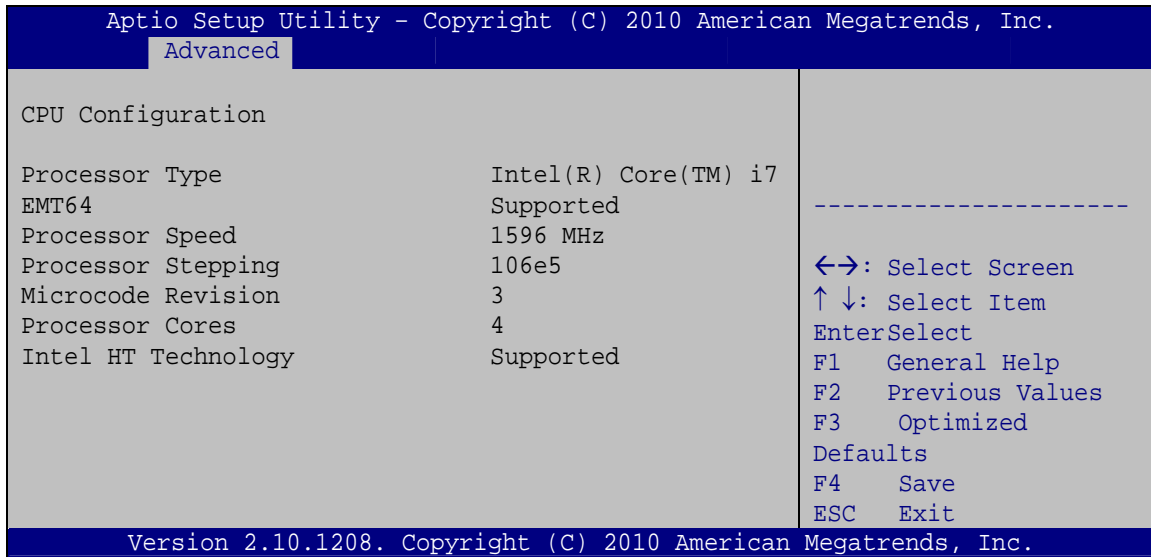

#### BIOS Menu 5: CPU Configuration

The CPU Configuration menu (**BIOS Menu 5**) lists the following CPU details:

- Processor Type: Lists the brand name of the CPU being used
- EMT64: Indicates if the EM64T is supported by the CPU.
- Processor Speed: Lists the CPU processing speed
- Processor Stepping: Lists the CPU processing stepping
- Microcode Revision: Lists the microcode revision
- Processor Cores: Lists the number of the processor core
- Intel HT Technology: Indicates if the Intel HT Technology is supported by the CPU.

## NOVA-HM551 5.25" SBC

### 5.3.4 SATA Configuration

Use the **SATA Configuration** menu (**BIOS Menu 6**) to change and/or set the configuration of the SATA devices installed in the system.

```

Aptio Setup Utility - Copyright (C) 2010 American Megatrends, Inc.
  Advanced
SATA Configuration
SATA Port0          Not Present
SATA Port1          Not Present
SATA Port2          Not Present
SATA Port3          Not Present

SATA Mode           [IDE Mode]
Serial-ATA Controller 0 [Compatible]
Serial-ATA Controller 1 [Enhanced]

(1) IDE Mode. (2) AHCI
Mode. (3) RAID Mode.

-----
<->: Select Screen
↑ ↓: Select Item
Enter>Select
F1   General Help
F2   Previous Values
F3   Optimized
Defaults
F4   Save
ESC  Exit

Version 2.10.1208. Copyright (C) 2010 American Megatrends, Inc.
  
```

#### BIOS Menu 6: IDE Configuration

##### → SATA Mode [IDE Mode]

Use the **SATA Mode** option to configure SATA devices as normal IDE devices.

- **Disable**                      Disables SATA devices.
- **IDE Mode**      **DEFAULT**      Configures SATA devices as normal IDE device.
- **AHCI Mode**                      Configures SATA devices as AHCI device.

##### → Serial-ATA Controller 0/1

Use the **Serial-ATA Controller** option to configure the Serial-ATA controller mode when the SATA mode is set to IDE Mode.

- **Disable**                      Disables Serial-ATA controller.

- ➔ **Enhanced**                      Configures the Serial-ATA controller to be in enhanced mode. In this mode, IDE channels and SATA channels are separated. Some legacy OS do not support this mode.
  
- ➔ **Compatible**                      Configures the Serial-ATA controller to be in compatible mode. In this mode, a SATA channel will replace one of the IDE channels.

### 5.3.5 USB Configuration

Use the **USB Configuration** menu (**BIOS Menu 7**) to read USB configuration information and configure the USB settings.

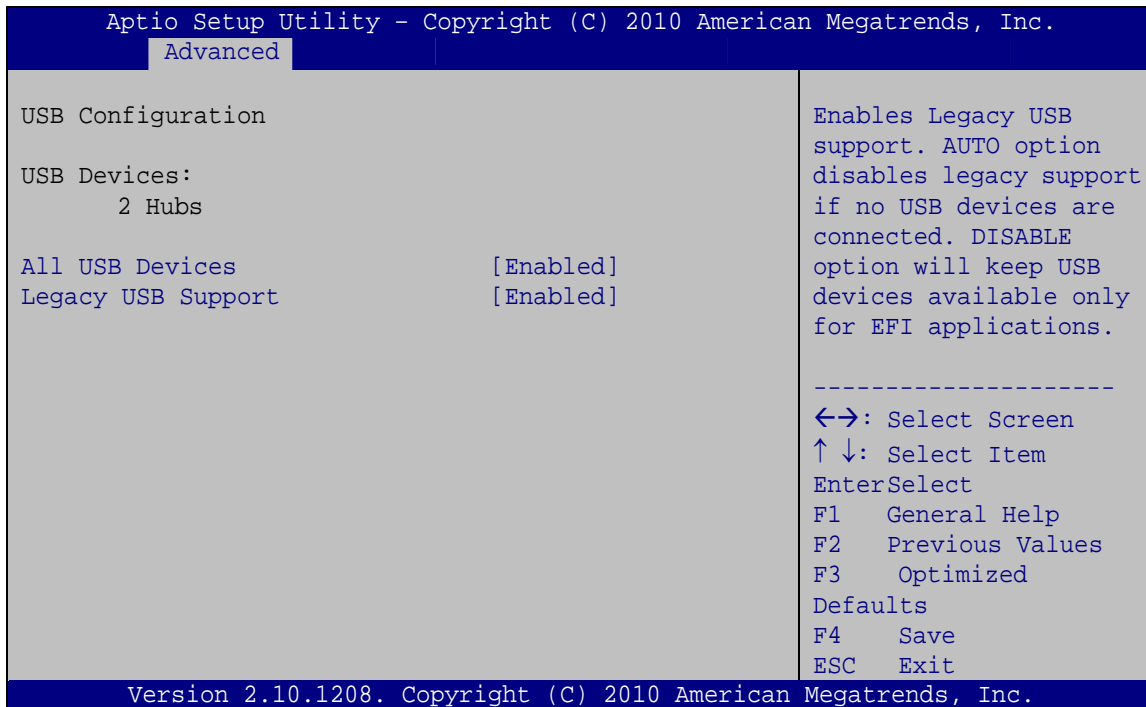

#### BIOS Menu 7: USB Configuration

#### ➔ USB Devices

The **USB Devices Enabled** field lists the USB devices that are enabled on the system



## NOVA-HM551 5.25" SBC

### → All USB Devices [Enabled]

Use the **All USB Devices** option to enable the USB devices.

- **Disabled** All USB devices are disabled.
- **Enabled** **DEFAULT** All USB devices are enabled.

### → Legacy USB Support [Enabled]

Use the **Legacy USB Support** BIOS option to enable USB mouse and USB keyboard support. Normally if this option is not enabled, any attached USB mouse or USB keyboard does not become available until a USB compatible operating system is fully booted with all USB drivers loaded. When this option is enabled, any attached USB mouse or USB keyboard can control the system even when there is no USB driver loaded onto the system.

- **Enabled** **DEFAULT** Legacy USB support enabled
- **Disabled** Legacy USB support disabled
- **Auto** Legacy USB support disabled if no USB devices are connected

### 5.3.6 Super IO Configuration

Use the **Super IO Configuration** menu (**BIOS Menu 8**) to set or change the configurations for the FDD controllers, parallel ports and serial ports.

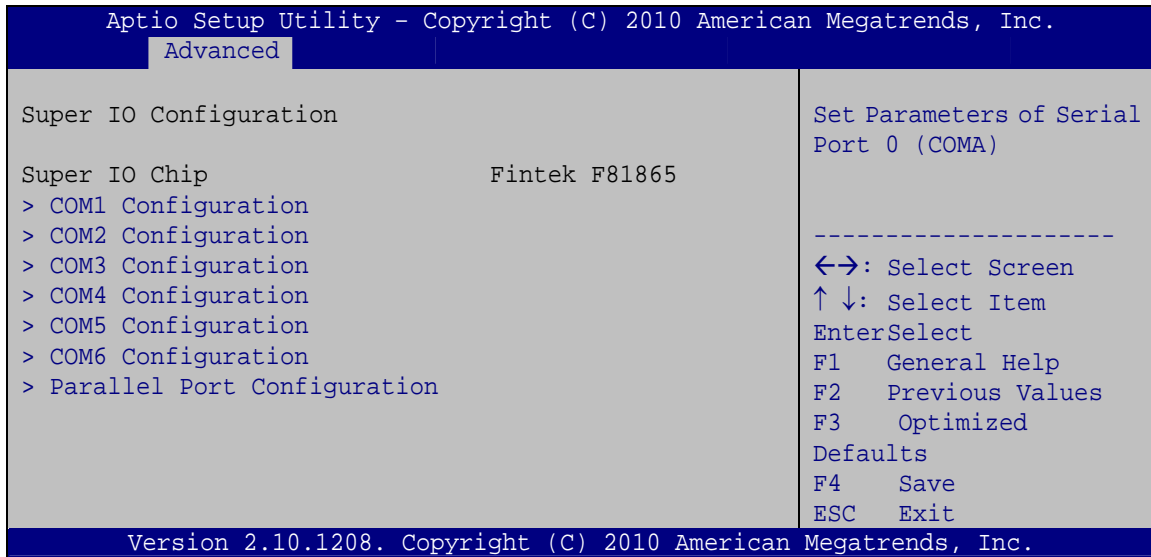

**BIOS Menu 8: Super IO Configuration**

#### 5.3.6.1 COM n Configuration

Use the **COM n Configuration** menu (**BIOS Menu 9**) to configure the serial port n.

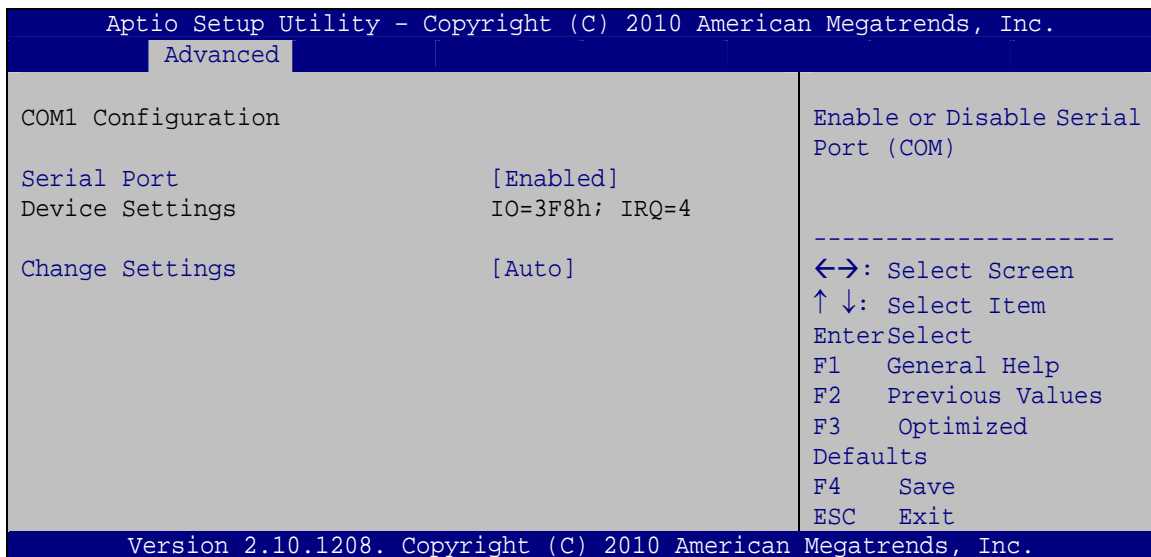

**BIOS Menu 9: COM n Configuration Menu**

## NOVA-HM551 5.25" SBC

### 5.3.6.1.1 COM1 Configuration

#### → Serial Port [Enabled]

Use the **Serial Port** option to enable or disable the serial port.

- **Disabled**                      Disable the serial port
- **Enabled**      **DEFAULT**      Enable the serial port

#### → Change Settings [Auto]

Use the **Change Settings** option to change the serial port IO port address and interrupt address.

- **Auto**              **DEFAULT**      The serial port IO port address and interrupt address are automatically detected.
- **IO=3F8h;**  
**IRQ=4**                      Serial Port I/O port address is 3F8h and the interrupt address is IRQ4
- **IO=3F8h;**  
**IRQ=3, 4**                      Serial Port I/O port address is 3F8h and the interrupt address is IRQ3, 4
- **IO=2F8h;**  
**IRQ=3, 4**                      Serial Port I/O port address is 2F8h and the interrupt address is IRQ3, 4
- **IO=2C0h;**  
**IRQ=3, 4**                      Serial Port I/O port address is 2C0h and the interrupt address is IRQ3, 4
- **IO=2C8h;**  
**IRQ=3, 4**                      Serial Port I/O port address is 2C8h and the interrupt address is IRQ3, 4

### 5.3.6.1.2 COM2 Configuration

#### → Serial Port [Enabled]

Use the **Serial Port** option to enable or disable the serial port.

- **Disabled**                      Disable the serial port

→ **Enabled**      **DEFAULT**      Enable the serial port

→ **Change Settings [Auto]**

Use the **Change Settings** option to change the serial port IO port address and interrupt address.

→ **Auto**      **DEFAULT**      The serial port IO port address and interrupt address are automatically detected.

→ **IO=2F8h;**  
**IRQ=3**      Serial Port I/O port address is 2F8h and the interrupt address is IRQ3

→ **IO=3F8h;**  
**IRQ=3, 4**      Serial Port I/O port address is 3F8h and the interrupt address is IRQ3, 4

→ **IO=2F8h;**  
**IRQ=3, 4**      Serial Port I/O port address is 2F8h and the interrupt address is IRQ3, 4

→ **IO=2C0h;**  
**IRQ=3, 4**      Serial Port I/O port address is 2C0h and the interrupt address is IRQ3, 4

→ **IO=2C8h;**  
**IRQ=3, 4**      Serial Port I/O port address is 2C8h and the interrupt address is IRQ3, 4

### 5.3.6.1.3 COM3 Configuration

→ **Serial Port [Enabled]**

Use the **Serial Port** option to enable or disable the serial port.

→ **Disabled**      Disable the serial port

→ **Enabled**      **DEFAULT**      Enable the serial port

→ **Change Settings [Auto]**

Use the **Change Settings** option to change the serial port IO port address and interrupt address.

## NOVA-HM551 5.25" SBC

- **Auto**      **DEFAULT**      The serial port IO port address and interrupt address are automatically detected.
- **IO=3E8h;**  
**IRQ=11**      Serial Port I/O port address is 3E8h and the interrupt address is IRQ11
- **IO=3E8h;**  
**IRQ=10, 11**      Serial Port I/O port address is 3E8h and the interrupt address is IRQ10, 11
- **IO=2E8h;**  
**IRQ=10, 11**      Serial Port I/O port address is 2E8h and the interrupt address is IRQ10, 11
- **IO=2D0h;**  
**IRQ=10, 11**      Serial Port I/O port address is 2D0h and the interrupt address is IRQ10, 11
- **IO=2D8h;**  
**IRQ=10, 11**      Serial Port I/O port address is 2D8h and the interrupt address is IRQ10, 11

### 5.3.6.1.4 COM4 Configuration

#### → Serial Port [Enabled]

Use the **Serial Port** option to enable or disable the serial port.

- **Disabled**      Disable the serial port
- **Enabled**      **DEFAULT**      Enable the serial port

#### → Change Settings [Auto]

Use the **Change Settings** option to change the serial port IO port address and interrupt address.

- **Auto**      **DEFAULT**      The serial port IO port address and interrupt address are automatically detected.
- **IO=2E8h;**  
**IRQ=11**      Serial Port I/O port address is 2E8h and the interrupt address is IRQ11
- **IO=3E8h;**  
**IRQ=10, 11**      Serial Port I/O port address is 3E8h and the interrupt address is IRQ10, 11

- **IO=2E8h;**  
**IRQ=10, 11**      Serial Port I/O port address is 2E8h and the interrupt address is IRQ10, 11
- **IO=2D0h;**  
**IRQ=10, 11**      Serial Port I/O port address is 2D0h and the interrupt address is IRQ10, 11
- **IO=2D8h;**  
**IRQ=10, 11**      Serial Port I/O port address is 2D8h and the interrupt address is IRQ10, 11

### 5.3.6.1.5 COM5 Configuration

#### → Serial Port [Enabled]

Use the **Serial Port** option to enable or disable the serial port.

- **Disabled**      Disable the serial port
- **Enabled**      **DEFAULT**      Enable the serial port

#### → Change Settings [Auto]

Use the **Change Settings** option to change the serial port IO port address and interrupt address.

- **Auto**      **DEFAULT**      The serial port IO port address and interrupt address are automatically detected.
- **IO=2E0h;**  
**IRQ=11**      Serial Port I/O port address is 2E0h and the interrupt address is IRQ11
- **IO=2E0h;**  
**IRQ=10, 11**      Serial Port I/O port address is 2E0h and the interrupt address is IRQ10, 11
- **IO=2D0h;**  
**IRQ=10, 11**      Serial Port I/O port address is 2D0h and the interrupt address is IRQ10, 11
- **IO=2D8h;**  
**IRQ=10, 11**      Serial Port I/O port address is 2D8h and the interrupt address is IRQ10, 11
- **IO=2B0h;**  
**IRQ=10, 11**      Serial Port I/O port address is 2B0h and the interrupt address is IRQ10, 11

### 5.3.6.1.6 COM6 Configuration

➔ **Serial Port [Enabled]**

Use the **Serial Port** option to enable or disable the serial port.

- ➔ **Disabled**                      Disable the serial port
- ➔ **Enabled**      **DEFAULT**      Enable the serial port

➔ **Change Settings [Auto]**

Use the **Change Settings** option to change the serial port IO port address and interrupt address.

- ➔ **Auto**              **DEFAULT**      The serial port IO port address and interrupt address are automatically detected.
- ➔ **IO=2D0h;**  
**IRQ=11**                      Serial Port I/O port address is 2D0h and the interrupt address is IRQ11
- ➔ **IO=2E0h;**  
**IRQ=10, 11**                      Serial Port I/O port address is 2E0h and the interrupt address is IRQ10, 11
- ➔ **IO=2D0h;**  
**IRQ=10, 11**                      Serial Port I/O port address is 2D0h and the interrupt address is IRQ10, 11
- ➔ **IO=2D8h;**  
**IRQ=10, 11**                      Serial Port I/O port address is 2D8h and the interrupt address is IRQ10, 11
- ➔ **IO=2B0h;**  
**IRQ=10, 11**                      Serial Port I/O port address is 2B0h and the interrupt address is IRQ10, 11

### 5.3.6.1.7 Parallel Port Configuration

➔ **Parallel Port [Enabled]**

Use the **Parallel Port** option to enable or disable the parallel port.

- ➔ **Disabled**                      Disable the parallel port
- ➔ **Enabled**            **DEFAULT**            Enable the parallel port

➔ **Change Settings [Auto]**

Use the **Change Settings** option to change the parallel port IO port address and interrupt address.

- ➔ **Auto**            **DEFAULT**            The parallel port IO port address and interrupt address are automatically detected.
- ➔ **IO=378h;**  
**IRQ=7**                      Parallel Port I/O port address is 378h and the interrupt address is IRQ7
- ➔ **IO=278h;**  
**IRQ=7**                      Parallel Port I/O port address is 278h and the interrupt address is IRQ7
- ➔ **IO=3BCh;**  
**IRQ=7**                      Parallel Port I/O port address is 3BCh and the interrupt address is IRQ7
- ➔ **IO=378h**                      Parallel Port I/O port address is 378h
- ➔ **IO=278h**                      Parallel Port I/O port address is 278h
- ➔ **IO=3BCh**                      Parallel Port I/O port address is 3BCh

➔ **Device Mode [Standard and Bi-direction (SPP) mode]**

Use the **Device Mode** option to select the mode the parallel port operates in.

- Standard and Bi-direction (SPP) mode
- EPP-1.9 and SPP mode
- ECP mode
- ECP and EPP 1.9 mode
- Printer mode
- EPP 1.7 and SPP mode
- ECP and EPP 1.7 mode



## NOVA-HM551 5.25" SBC

### 5.3.7 H/W Monitor

The H/W Monitor menu (**BIOS Menu 10**) shows the operating temperature, fan speeds and system voltages.

```

Aptio Setup Utility - Copyright (C) 2010 American Megatrends, Inc.
-----
Advanced
-----
PC Health Status

CPU Temperature           :+40 C
SYS Temperature          :+28 C
CPU FAN Speed             :4587 RPM
SYS FAN Speed             :N/A
VCC3V                     :+3.344 V
V_core                    :+1.088 V
+5V                       :+5.129 V
+12V                      :+11.176 V
+1.5V                     :+1.600 V
VSB3V                     :+3.344 V
VBAT                      :+3.264 V

CPU Smart Fan Control     [Auto Mode]
Temperature Bound 1       60
Temperature Bound 2       50
Temperature Bound 3       40
Temperature Bound 4       30

-----
<->: Select Screen
↑ ↓: Select Item
Enter>Select
F1   General Help
F2   Previous Values
F3   Optimized
Defaults
F4   Save
ESC  Exit

Version 2.10.1208. Copyright (C) 2010 American Megatrends, Inc.

```

#### BIOS Menu 10: Hardware Health Configuration

##### → CPU Smart Fan Control [Auto Mode]

Use the **CPU Smart Fan Control** option to configure the CPU fan.

- **Auto Mode**      **DEFAULT**      The fan adjusts its speed using these settings by RPM:
  - Temperature Bound 1
  - Temperature Bound 2
  - Temperature Bound 3
  - Temperature Bound 4

---

→ **Manual Mode**

The fan spins at the speed set in:  
Manual Duty Cycle Setting  
(Min=0, Max=100)



**NOTE:**

Smart fan functions are supported only when using a 4-pin fan. When using a 3-pin fan, the functions are not supported.

---

→ **First Boundary Temperature [60]**



**WARNING:**

CPU failure can result if this value is set too high

---

When the fan is off, it will only start when the temperature exceeds this setting.

- Minimum Value: 0°C
- Maximum Value: 127°C

→ **Second Boundary Temperature [50]**



**WARNING:**

CPU failure can result if this value is set too high

---

When the fan is off, it will only start when the temperature exceeds this setting.

- Minimum Value: 0°C
- Maximum Value: 127°C

## NOVA-HM551 5.25" SBC

### → Third Boundary Temperature [40]

---



#### **WARNING:**

CPU failure can result if this value is set too high

---

When the fan is off, it will only start when the temperature exceeds this setting.

- Minimum Value: 0°C
- Maximum Value: 127°C

### → Fourth Boundary Temperature [30]

---



#### **WARNING:**

CPU failure can result if this value is set too high

---

When the fan is off, it will only start when the temperature exceeds this setting.

- Minimum Value: 0°C
- Maximum Value: 127°C

### → PC Health Status

The following system parameters and values are shown. The system parameters that are monitored are:

- System Temperatures:
  - CPU Temperature
  - System Temperature
- Fan Speeds:
  - CPU Fan Speed
  - System Fan Speed
- Voltages:
  - VCC3V
  - V\_core

- +5V
- +12 V
- +1.5V
- VSB3V
- VBAT

### 5.3.8 Serial Port Console Redirection

The **Serial Port Console Redirection** menu (**BIOS Menu 11**) allows the console redirection options to be configured. Console redirection allows users to maintain a system remotely by re-directing keyboard input and text output through the serial port.

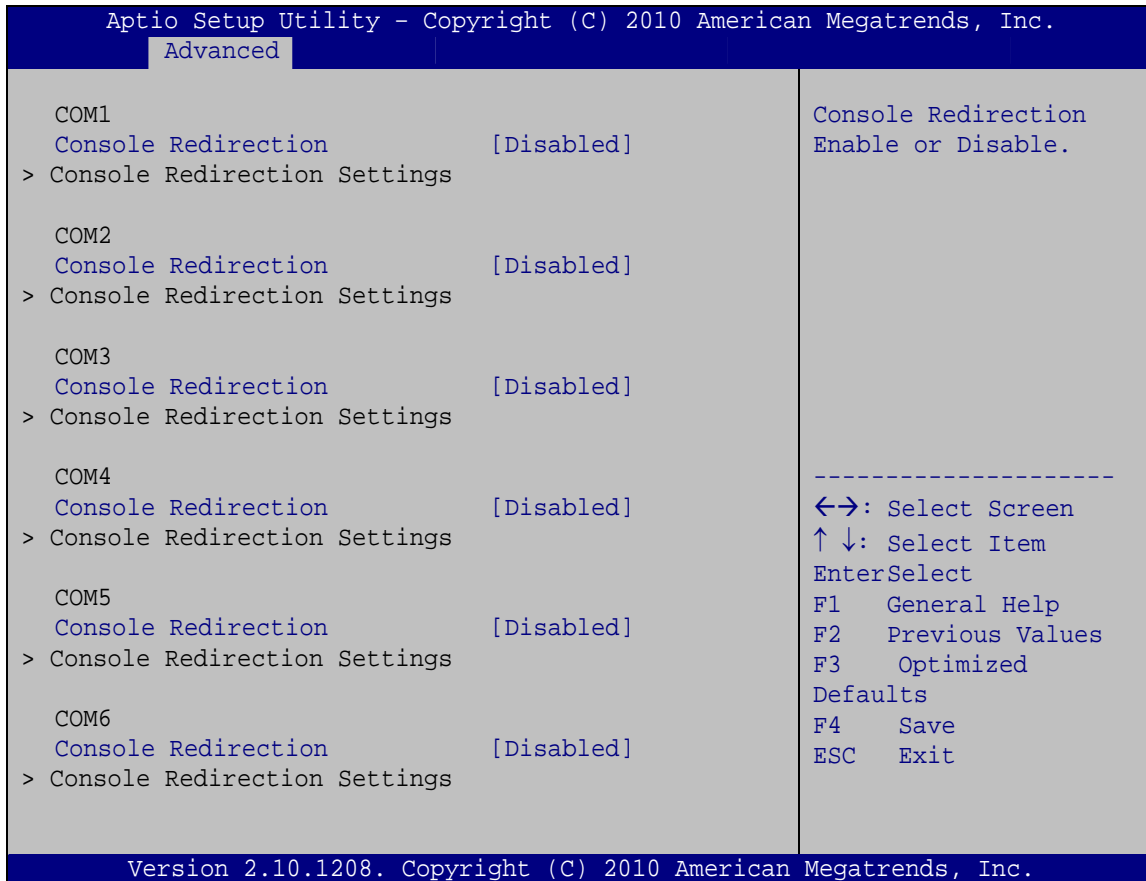

#### BIOS Menu 11: Serial Port Console Redirection

##### → Console Redirection

Use **Console Redirection** option to enable or disable the console redirection function.

## NOVA-HM551 5.25" SBC

- ➔ **Disabled**                      Disabled the console redirection function
- ➔ **Enabled**                        Enabled the console redirection function

### 5.3.8.1 Console Redirection Settings

The **Console Redirection Settings** menu (**BIOS Menu 12**) allows the console redirection options to be configured. The option is active when Console Redirection option is enabled.

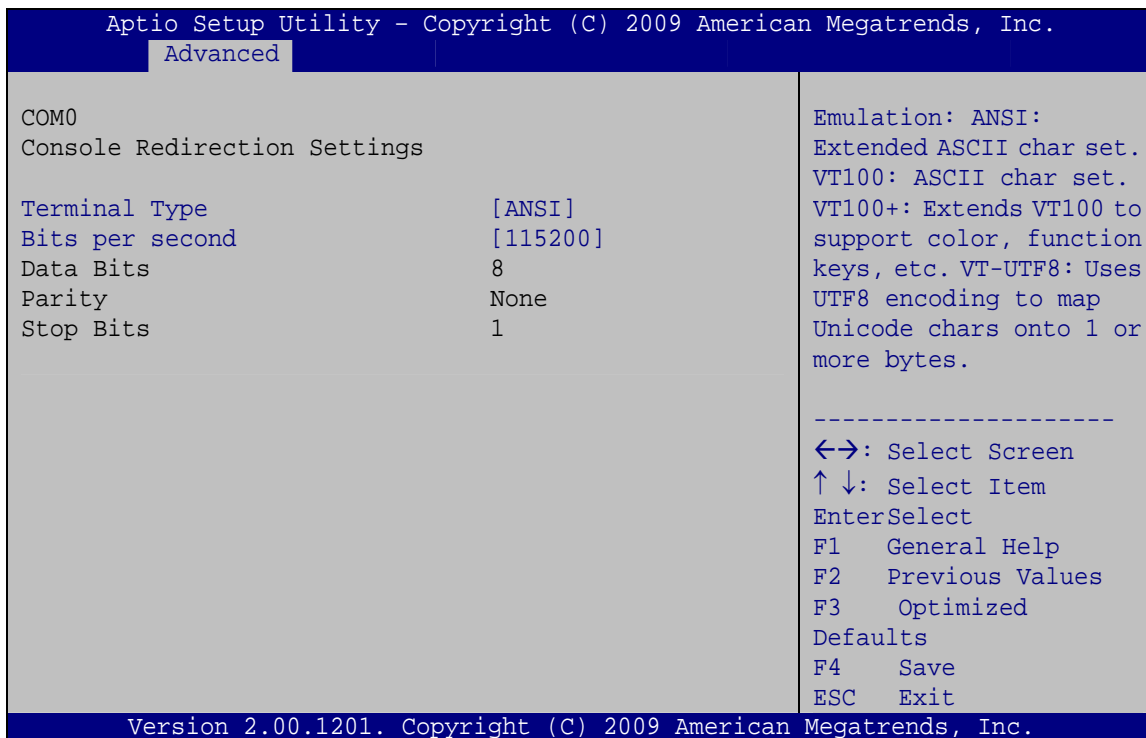

#### BIOS Menu 12: Console Redirection Settings

##### ➔ **Terminal Type [ANSI]**

Use the **Terminal Type** option to specify the remote terminal type..

- ➔ **VT100**                            The target terminal type is VT100
- ➔ **VT100+**                        The target terminal type is VT100+
- ➔ **VT-UTF8**                        The target terminal type is VT-UTF8
- ➔ **ANSI**                            **DEFAULT**                      The target terminal type is ANSI

→ **Bits per second [115200]**

Use the **Bits per second** option to specify the transmission speed of the serial port.

- **9600**                                      The transmission speed is 9600
- **19200**                                     The transmission speed is 19200
- **57600**                                    The transmission speed is 57600
- **115200**                                  **DEFAULT**                                  The transmission speed is 115200

## 5.4 Chipset

Use the **Chipset** menu (**BIOS Menu 13**) to access the Northbridge and Southbridge configuration menus



### **WARNING!**

Setting the wrong values for the Chipset BIOS selections in the Chipset BIOS menu may cause the system to malfunction.

```

Aptio Setup Utility - Copyright (C) 2010 American Megatrends, Inc.
Main   Advanced  Chipset  Boot   Security  Save & Exit
-----
> North Bridge
> South Bridge
> Intel IDG SWSCI OpRegion

North Bridge Parameters
-----
<=>: Select Screen
↑ ↓: Select Item
Enter>Select
F1   General Help
F2   Previous Values
F3   Optimized
Defaults
F4   Save
ESC  Exit

Version 2.10.1208. Copyright (C) 2010 American Megatrends, Inc.
    
```

**BIOS Menu 13: Chipset**

## NOVA-HM551 5.25" SBC

### 5.4.1 North Bridge Configuration

Use the **North Bridge Chipset Configuration** menu (**BIOS Menu 14**) to configure the Northbridge chipset.

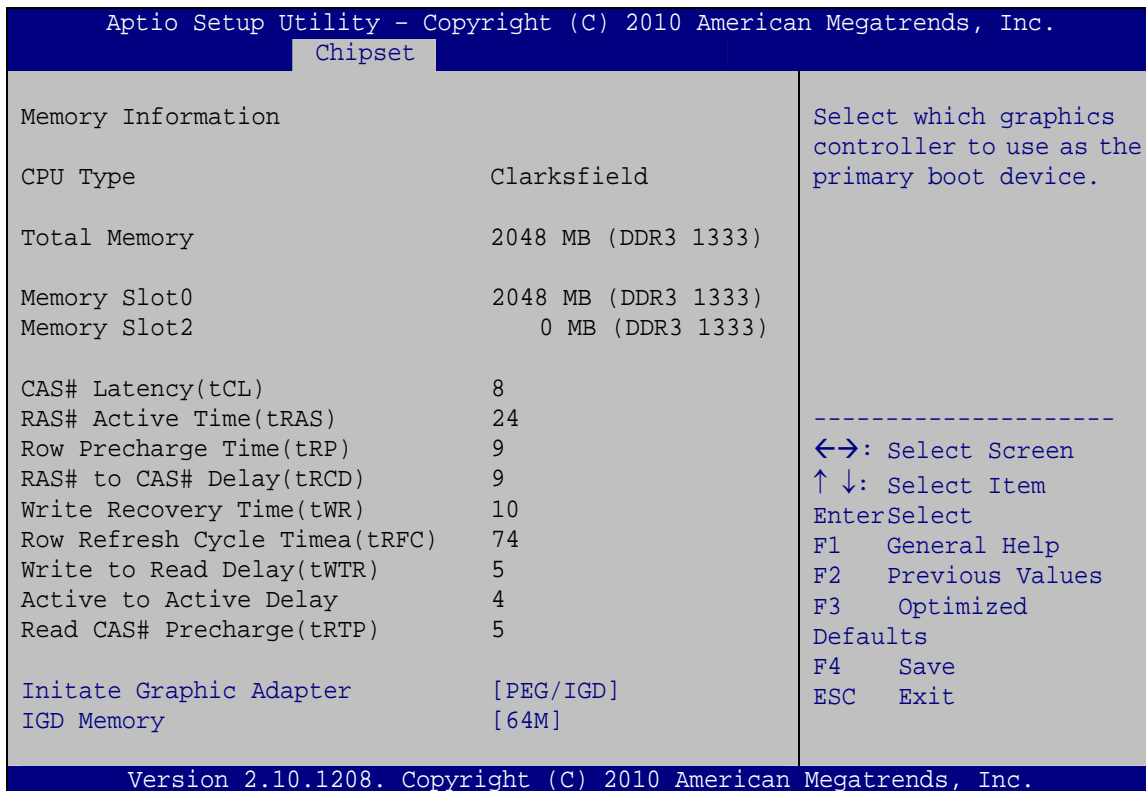

#### BIOS Menu 14:North Bridge Chipset Configuration

##### → Initiate Graphics Adapter [PEG/IGD]

Use the **Initiate Graphics Adapter** option to select the graphics controller used as the primary boot device. Select either an integrated graphics controller (IGD) or a combination of PCI graphics controller, a PCI express (PEG) controller or an IGD. Configuration options are listed below:

- IGD
- PEG/IGD      **DEFAULT**

**→ IGD Memory [64 MB]**

Use the **IGD Memory** option to specify the amount of system memory that can be used by the Internal graphics device.

- Disable**
- 32 MB** 32 MB of memory used by internal graphics device
- 64 MB** **DEFAULT** 64 MB of memory used by internal graphics device

**5.4.2 South Bridge Configuration**

Use the **South Bridge Configuration** menu (**BIOS Menu 15**) to configure the Southbridge chipset.

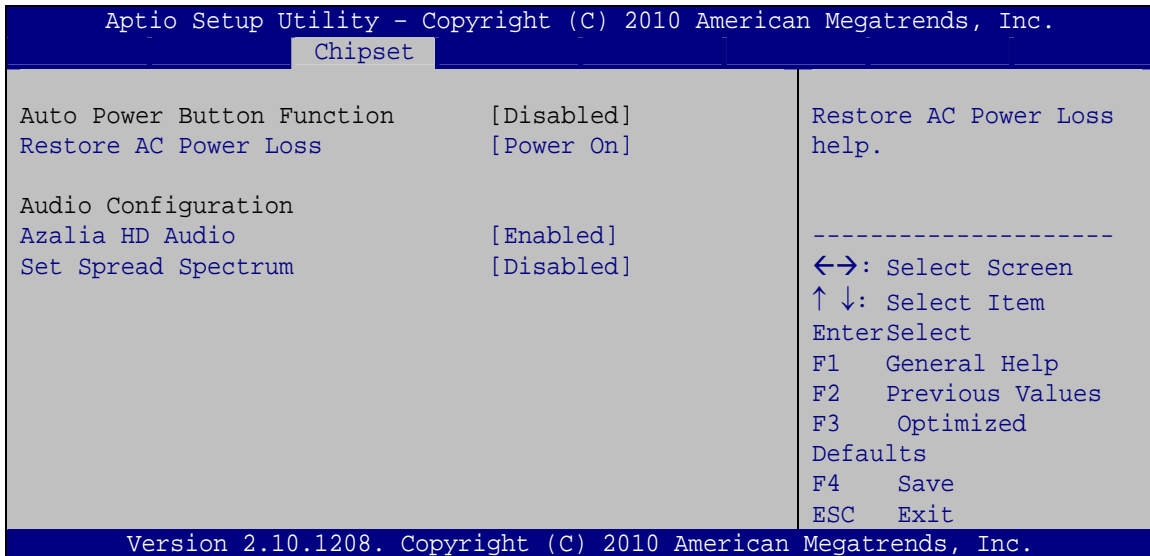
**BIOS Menu 15:South Bridge Chipset Configuration****→ Restore AC Power Loss [Power On]**

Use the **Restore on AC Power Loss** BIOS option to specify what state the system returns to if there is a sudden loss of power to the system.

- Power Off** The system remains turned off
- Power On** **DEFAULT** The system turns on



## NOVA-HM551 5.25" SBC

### → Azalia HD Audio [Enabled]

Use the **Azalia HD Audio** option to enable or disable the High Definition Audio controller.

- **Disabled**                      The onboard High Definition Audio controller is disabled
- **Enabled**    **DEFAULT**      The onboard High Definition Audio controller automatically detected and enabled

### → Set Spread Spectrum [Disabled]

Use the **Set Spread Spectrum** option to reduce the EMI. Excess EMI is generated when the system clock generator pulses have extreme values. Spreading the pulse spectrum modulates changes in the extreme values from spikes to flat curves, thus reducing the EMI. This benefit may in some cases be outweighed by problems with timing-critical devices, such as a clock-sensitive SCSI device.

- **Disabled**    **DEFAULT**      EMI not reduced
- **Enabled**                      EMI reduced

### 5.4.3 Intel IGD SWSCI OpRegion

Use the **Intel IGD SWSCI OpRegion** menu to configure the video device connected to the system.

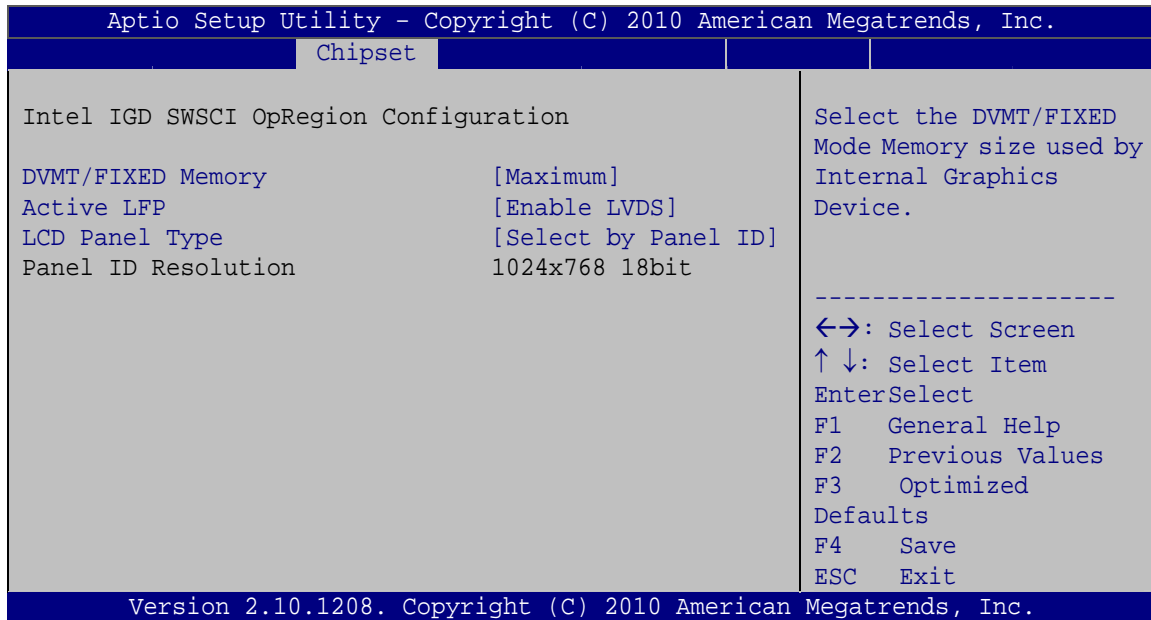

#### BIOS Menu 16: Intel IGD SWSCI OpRegion

##### → DVMT/FIXED Memory [Maximum]

Use the **DVMT/FIXED Memory** option to specify the maximum amount of memory that can be allocated as graphics memory. Configuration options are listed below.

- 128 MB
- 256 MB
- Maximum **Default**

##### → Active LFP [Enable LVDS]

Use the **Active LFP** option to enable the LVDS connector. Configuration options are listed below.

- Disable LVDS
- Enable LVDS **DEFAULT**

## NOVA-HM551 5.25" SBC

### → LCD Panel Type [Select by Panel ID]

Use the **LCD Panel Type** option to select the type of flat panel connected to the system.

Configuration options are listed below.

- Select by Panel ID **DEFAULT**
- 800x600 18bit
- 1024x768 18bit
- 1024x768 24bit
- 1280x800 18bit
- 1280x1024 48bit
- 1366x768 18bit
- 1400x1050 48bit
- 1440x900 48bit
- 1600x900 48bit
- 1600x1200 48bit
- 1680x1050 48bit
- 1920x1080 48bit
- 1920x1200 48bit
- 2048x1536 48bit

### → Panel ID Resolution

Displays the panel resolution detected by the BIOS.

## 5.5 Boot

Use the **Boot** menu (**BIOS Menu 17**) to configure system boot options.

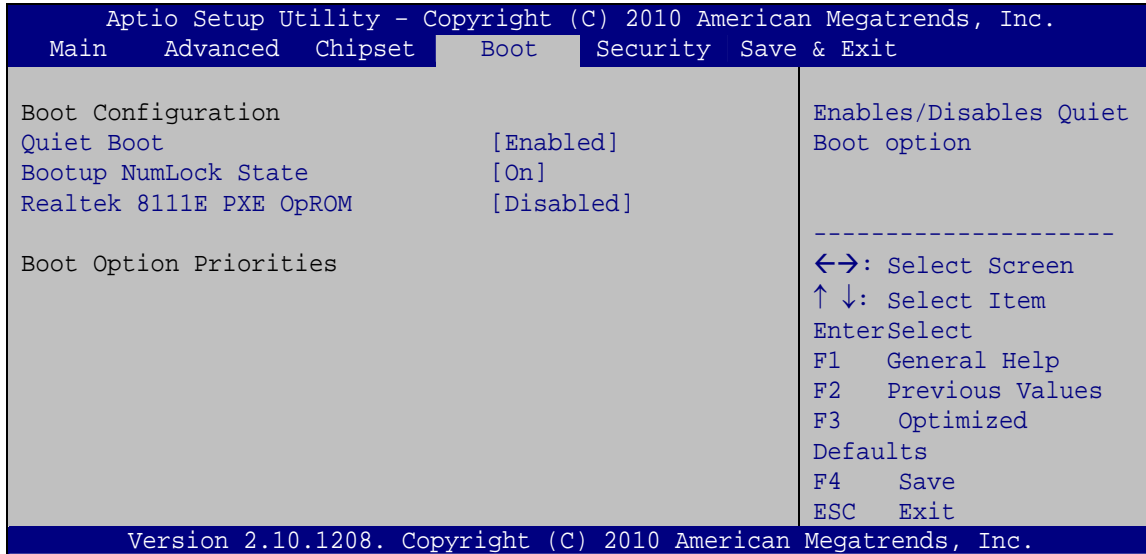

### BIOS Menu 17: Boot

#### → Quiet Boot [Enabled]

Use the **Quiet Boot** BIOS option to select the screen display when the system boots.

- **Disabled**                      Normal POST messages displayed
- **Enabled**      **DEFAULT**      OEM Logo displayed instead of POST messages

#### → Bootup NumLock [On]

Use the **Bootup NumLock** BIOS option to specify if the number lock setting must be modified during boot up.

- **Off**                              Does not enable the keyboard Number Lock automatically. To use the 10-keys on the keyboard, press the Number Lock key located on the upper left-hand corner of the 10-key pad. The Number Lock LED on the keyboard lights up when the Number Lock is engaged.

## NOVA-HM551 5.25" SBC

- ➔ **On** **DEFAULT** Allows the Number Lock on the keyboard to be enabled automatically when the computer system boots up. This allows the immediate use of the 10-key numeric keypad located on the right side of the keyboard. To confirm this, the Number Lock LED light on the keyboard is lit.

### ➔ **Realtek 8111E PXE OpROM [Disabled]**

Use the **Realtek 8111E PXE OpROM** option to enable the Realtek 8111E PCIe GbE controller to boot the system.

- ➔ **Disabled** **DEFAULT** Cannot be booted from a remote system through the Realtek 8111E PCIe GbE controller
- ➔ **Enabled** Can be booted from a remote system through the Realtek 8111E PCIe GbE controller

## 5.6 Security

Use the **Security** menu (**BIOS Menu 18**) to set system and user passwords.

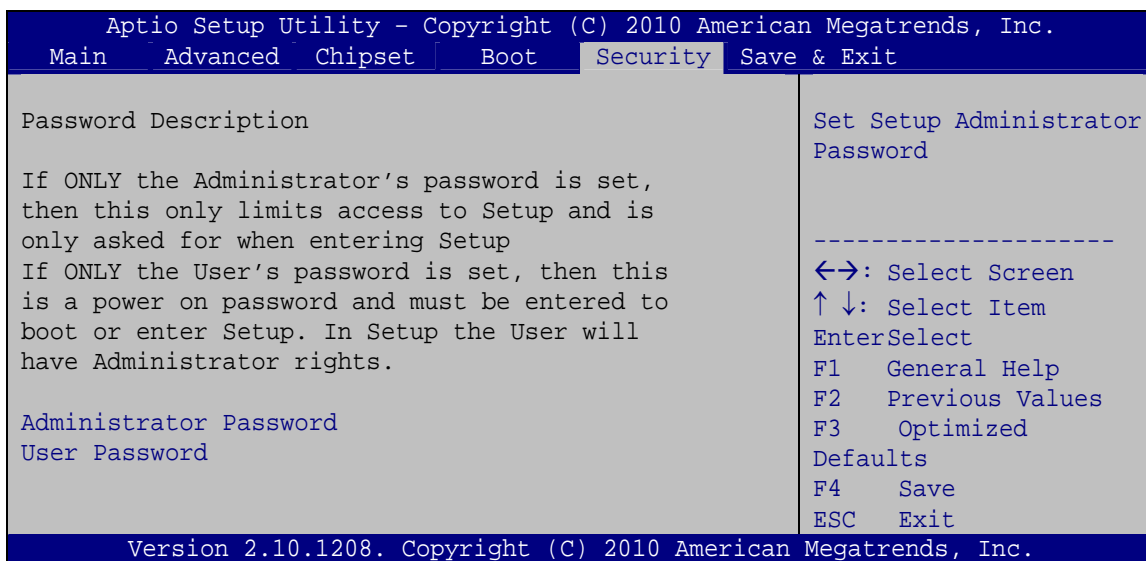

### **BIOS Menu 18: Security**

#### ➔ **Administrator Password**

Use the **Administrator Password** to set or change a administrator password.

## → User Password

Use the **User Password** to set or change a user password.

## 5.7 Exit

Use the **Exit** menu (**BIOS Menu 19**) to load default BIOS values, optimal failsafe values and to save configuration changes.

```
Aptio Setup Utility - Copyright (C) 2010 American Megatrends, Inc.
Main   Advanced   Chipset   Boot   Security   Save & Exit

Save Changes and Reset
Discard Changes and Reset

Restore Defaults
Save as User Defaults
Restore User Defaults

-----
←→: Select Screen
↑ ↓: Select Item
Enter>Select
F1   General Help
F2   Previous Values
F3   Optimized
Defaults
F4   Save
ESC  Exit

Version 2.10.1208. Copyright (C) 2010 American Megatrends, Inc.
```

### BIOS Menu 19:Exit

## → Save Changes and Reset

Use the **Save Changes and Reset** option to save the changes made to the BIOS options and to exit the BIOS configuration setup program.

## → Discard Changes and Reset

Use the **Discard Changes and Reset** option to exit the system without saving the changes made to the BIOS configuration setup program.

## → Restore Defaults

Use the **Restore Defaults** option to load the optimal default values for each of the parameters on the Setup menus. **F3 key can be used for this operation.**

## NOVA-HM551 5.25" SBC

### → Save as User Defaults

Use the **Save as User Defaults** option to save the changes done so far as user defaults.

### → Restore User Defaults

Use the **Restore User Defaults** option to restore the user defaults to all the setup options.

Appendix

A

# BIOS Menu Options

---



## NOVA-HM551 5.25" SBC

BIOS Information .....	76
Memory Information .....	76
System Date [xx/xx/xx] .....	77
System Time [xx:xx:xx] .....	77
ACPI Sleep State [S1 (CPU Stop Clock)] .....	78
TPM Support [Enable] .....	79
TPM State [Disabled] .....	79
SATA Mode [IDE Mode] .....	81
Serial-ATA Controller 0/1 .....	81
USB Devices .....	82
All USB Devices [Enabled] .....	83
Legacy USB Support [Enabled] .....	83
Serial Port [Enabled] .....	85
Change Settings [Auto] .....	85
Serial Port [Enabled] .....	85
Change Settings [Auto] .....	86
Serial Port [Enabled] .....	86
Change Settings [Auto] .....	86
Serial Port [Enabled] .....	87
Change Settings [Auto] .....	87
Serial Port [Enabled] .....	88
Change Settings [Auto] .....	88
Serial Port [Enabled] .....	89
Change Settings [Auto] .....	89
Parallel Port [Enabled] .....	89
Change Settings [Auto] .....	90
Device Mode [Standard and Bi-direction (SPP) mode] .....	90
CPU Smart Fan Control [Auto Mode] .....	91
First Boundary Temperature [60] .....	92
Second Boundary Temperature [50] .....	92
Third Boundary Temperature [40] .....	93
Fourth Boundary Temperature [30] .....	93
PC Health Status .....	93
Console Redirection .....	94

Terminal Type [ANSI].....	95
Bits per second [115200].....	96
Initiate Graphics Adapter [PEG/IGD].....	97
IGD Memory [64 MB].....	98
Restore AC Power Loss [Power On].....	98
Azalia HD Audio [Enabled].....	99
Set Spread Spectrum [Disabled] .....	99
DVMT/FIXED Memory [Maximum] .....	100
Active LFP [Enable LVDS].....	100
LCD Panel Type [Select by Panel ID] .....	101
Panel ID Resolution .....	101
Quiet Boot [Enabled] .....	102
Bootup NumLock [On].....	102
Realtek 8111E PXE OpROM [Disabled].....	103
Administrator Password .....	103
User Password .....	104
Save Changes and Reset .....	104
Discard Changes and Reset .....	104
Restore Defaults .....	104
Save as User Defaults .....	105
Restore User Defaults .....	105

Appendix

**B**

# One Key Recovery

---

## B.1 One Key Recovery Introduction

The IEI one key recovery is an easy-to-use front end for the Norton Ghost system backup and recovery tool. The one key recovery provides quick and easy shortcuts for creating a backup and reverting to that backup or for reverting to the factory default settings.

The IEI One Key Recovery tool menu is shown below.

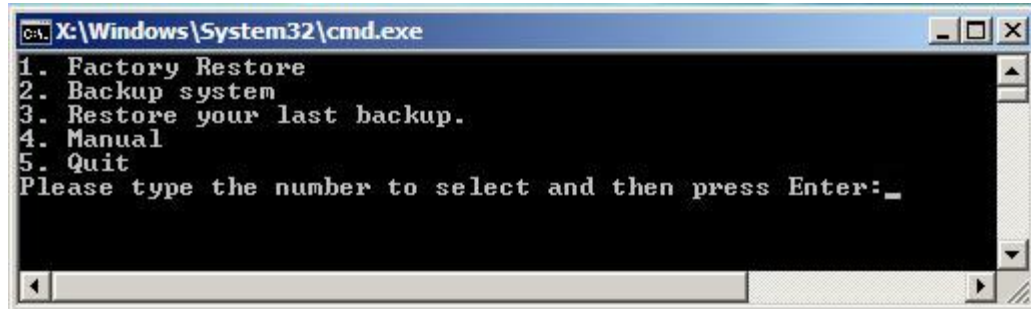

Figure B-1: IEI One Key Recovery Tool Menu

Prior to using the IEI One Key Recovery tool (as shown in **Figure B-1**) to backup or restore Windows system, five setup procedures are required.

1. Hardware and BIOS setup (see **Section B.2.1**)
2. Create partitions (see **Section B.2.2**)
3. Install operating system, drivers and system applications (see **Section B.2.3**)
4. Build-up recovery partition (see **Section B.2.4**)
5. Create factory default image (see **Section B.2.5**)

After completing the five initial setup procedures as described above, users can access the recovery tool by pressing <F3> while booting up the system. The detailed information of each function is described in **Section B.4**.



### NOTE:

The initial setup procedures for Linux system are described in **Section B.3**.

---

## NOVA-HM551 5.25" SBC

### B.1.1 System Requirement



#### NOTE:

The recovery CD can only be used with IEI products. The software will fail to run and a warning message will appear when used on non-IEI hardware.

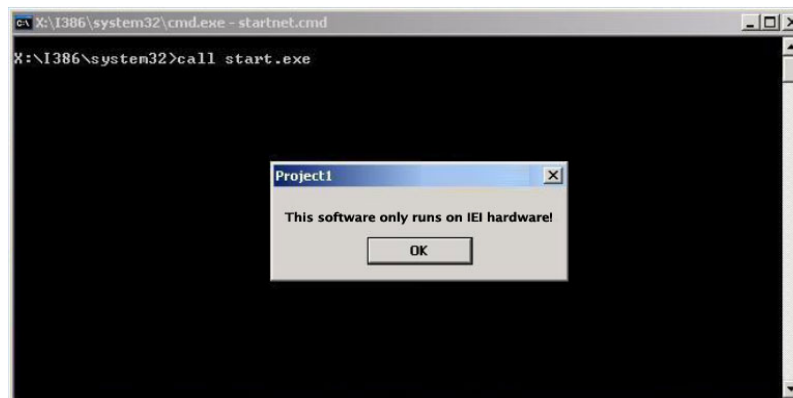

To create the system backup, the main storage device must be split into two partitions (three partitions for Linux). The first partition will be for the operating system, while the second partition will be invisible to the operating system and contain the backup made by the one key recovery software.

The partition created for recovery images must be big enough to contain both the factory default image and the user backup image. The size must be calculated before creating the partitions. Please take the following table as a reference when calculating the size of the partition.

	OS	OS Image after Ghost	Compression Ratio
<b>Windows® 7</b>	7 GB	5 GB	70%
<b>Windows® XPE</b>	776 MB	560 MB	70%
<b>Windows® CE 6.0</b>	36 MB	28 MB	77%

**NOTE:**

Specialized tools are required to change the partition size if the operating system is already installed.

### B.1.2 Supported Operating System

The recovery CD is compatible with both Microsoft Windows and Linux operating system (OS). The supported OS versions are listed below.

- Microsoft Windows
  - Windows XP (Service Pack 2 or 3 required)
  - Windows Vista
  - Windows 7
  - Windows CE 5.0
  - Windows CE 6.0
  - Windows XP Embedded
- Linux
  - Fedora Core 12 (Constantine)
  - Fedora Core 11 (Leonidas)
  - Fedora Core 10 (Cambridge)
  - Fedora Core 8 (Werewolf)
  - Fedora Core 7 (Moonshine)
  - RedHat RHEL-5.4
  - RedHat 9 (Ghirke)
  - Ubuntu 8.10 (Intrepid)
  - Ubuntu 7.10 (Gutsy)
  - Ubuntu 6.10 (Edgy)
  - Debian 5.0 (Lenny)
  - Debian 4.0 (Etch)
  - SuSe 11.2
  - SuSe 10.3

**NOTE:**

Installing unsupported OS versions may cause the recovery tool to fail.

## B.2 Setup Procedure for Windows

Prior to using the recovery tool to backup or restore Windows system, a few setup procedures are required.

**Step 1:** Hardware and BIOS setup (see **Section B.2.1**)

**Step 2:** Create partitions (see **Section B.2.2**)

**Step 3:** Install operating system, drivers and system applications (see **Section B.2.3**)

**Step 4:** Build-up recovery partition (see **Section B.2.4**)

**Step 5:** Create factory default image (see **Section B.2.5**)

The detailed descriptions are described in the following sections.

**NOTE:**

The setup procedures described below are for Microsoft Windows operating system users. For Linux system, most setup procedures are the same with Microsoft Windows except for several steps which is described in **Section B.3**.

### B.2.1 Hardware and BIOS Setup

**Step 1:** Make sure the system is powered off and unplugged.

**Step 2:** Install a hard drive or SSD in the system. An unformatted and unpartitioned disk is recommended.

**Step 3:** Connect an optical disk drive to the system and insert the recovery CD.

- Step 4:** Turn on the system.
- Step 5:** Press the <DELETE> key as soon as the system is turned on to enter the BIOS.
- Step 6:** Select the connected optical disk drive as the 1<sup>st</sup> boot device. (**Boot → Boot Device Priority → 1<sup>st</sup> Boot Device**).
- Step 7:** Save changes and restart the computer. Continue to the next section for instructions on partitioning the internal storage.

## B.2.2 Create Partitions

To create the system backup, the main storage device must be split into two partitions (three partitions for Linux). The first partition will be for the operating system, while the second partition will be invisible to the operating system and contain the backup made by the one key recovery software.

- Step 1:** Put the recovery CD in the optical drive of the system.
- Step 2:** **Boot the system from recovery CD.** When prompted, press any key to boot from the recovery CD. It will take a while to launch the recovery tool. Please be patient!

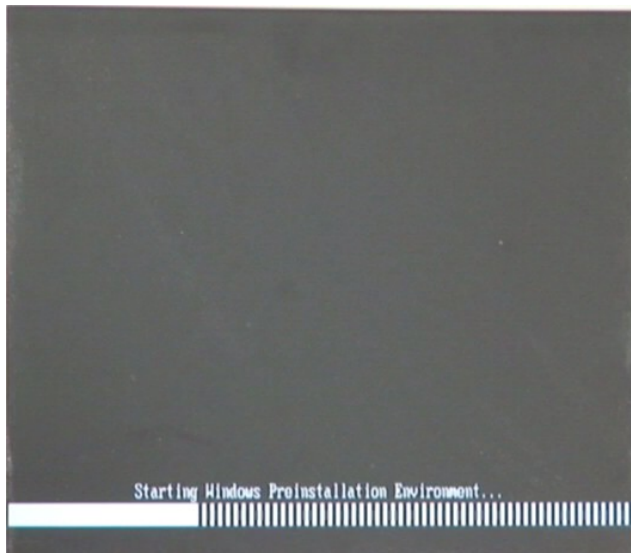
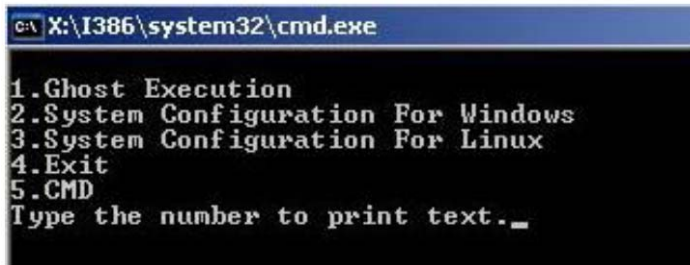

Figure B-2: Launching the Recovery Tool



## NOVA-HM551 5.25" SBC

**Step 3:** The recovery tool setup menu is shown as below.



```
C:\X:\I386\system32\cmd.exe
1.Ghost Execution
2.System Configuration For Windows
3.System Configuration For Linux
4.Exit
5.CMD
Type the number to print text._
```

Figure B-3: Recovery Tool Setup Menu

**Step 4:** Press <5> then <Enter>.

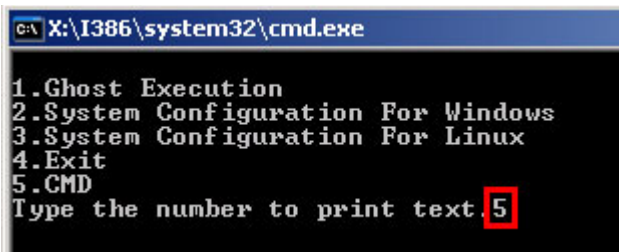

```
C:\X:\I386\system32\cmd.exe
1.Ghost Execution
2.System Configuration For Windows
3.System Configuration For Linux
4.Exit
5.CMD
Type the number to print text. 5
```

Figure B-4: Command Mode

**Step 5:** The command prompt window appears. Type the following commands (marked in red) to create two partitions. One is for the OS installation; the other is for saving recovery files and images which will be an invisible partition.

(Press <Enter> after entering each line below)

```
system32>diskpart
DISKPART>list vol
DISKPART>sel disk 0
DISKPART>create part pri size= ____
DISKPART>assign letter=N
DISKPART>create part pri size= ____
DISKPART>assign letter=F
DISKPART>exit
system32>format N: /fs:ntfs /q /y
```

system32>format F: /fs:ntfs /q /v:Recovery /y

system32>exit

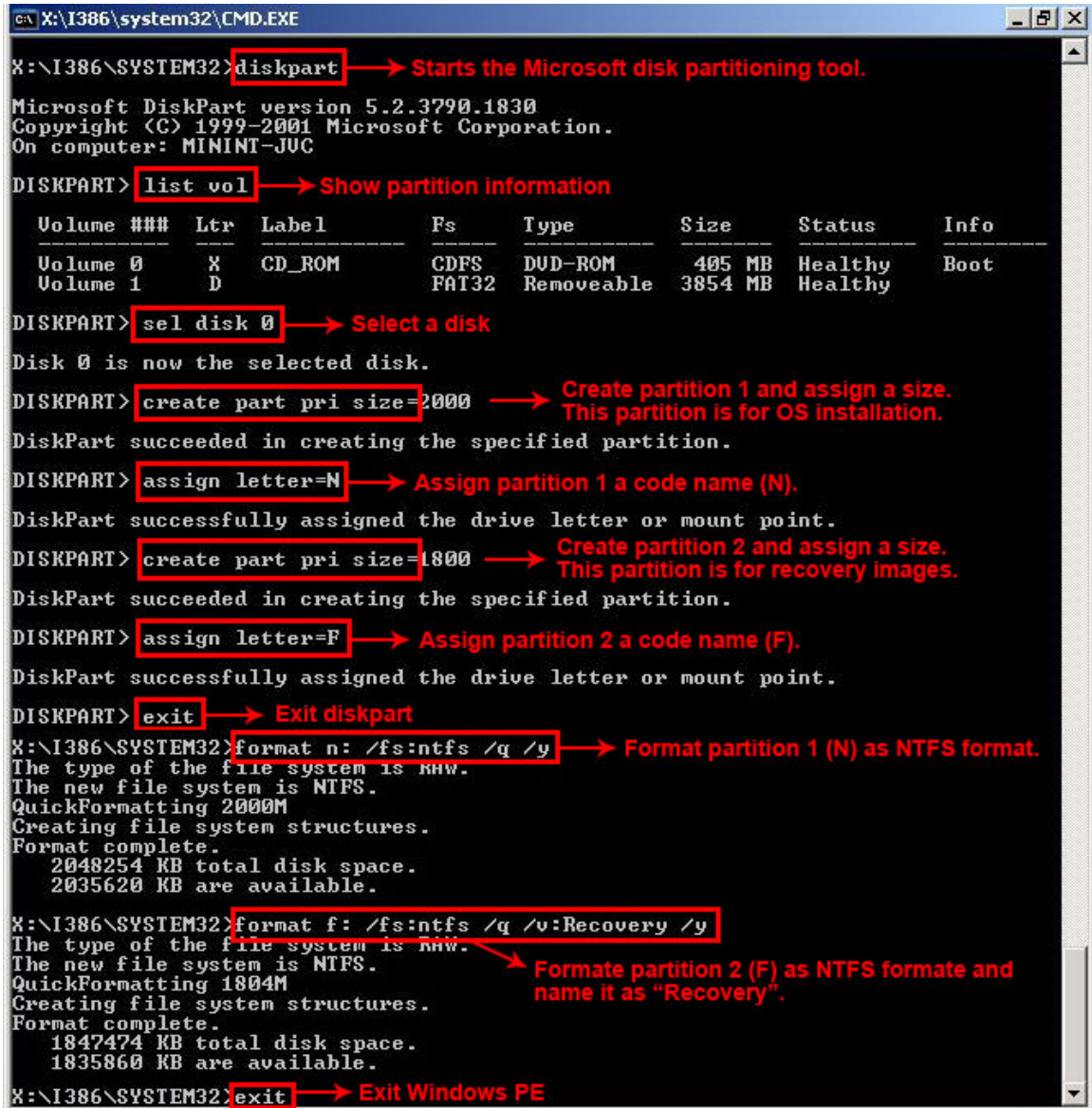

```
X:\I386\SYSTEM32\CMD.EXE
X:\I386\SYSTEM32>diskpart → Starts the Microsoft disk partitioning tool.
Microsoft DiskPart version 5.2.3790.1830
Copyright (C) 1999-2001 Microsoft Corporation.
On computer: MININT-JUC
DISKPART> list vol → Show partition information
Volume ### Ltr Label Fs Type Size Status Info
-----
Volume 0 X CD_ROM GDFS DUD-ROM 405 MB Healthy Boot
Volume 1 D FAT32 Removeable 3854 MB Healthy
DISKPART> sel disk 0 → Select a disk
Disk 0 is now the selected disk.
DISKPART> create part pri size=2000 → Create partition 1 and assign a size.
This partition is for OS installation.
DiskPart succeeded in creating the specified partition.
DISKPART> assign letter=N → Assign partition 1 a code name (N).
DiskPart successfully assigned the drive letter or mount point.
DISKPART> create part pri size=1800 → Create partition 2 and assign a size.
This partition is for recovery images.
DiskPart succeeded in creating the specified partition.
DISKPART> assign letter=F → Assign partition 2 a code name (F).
DiskPart successfully assigned the drive letter or mount point.
DISKPART> exit → Exit diskpart
X:\I386\SYSTEM32>format n: /fs:ntfs /q /y → Format partition 1 (N) as NTFS format.
The type of the file system is ntw.
The new file system is NTFS.
QuickFormatting 2000M
Creating file system structures.
Format complete.
2048254 KB total disk space.
2035620 KB are available.
X:\I386\SYSTEM32>format f: /fs:ntfs /q /v:Recovery /y → Formate partition 2 (F) as NTFS formate and
name it as "Recovery".
The type of the file system is ntw.
The new file system is NTFS.
QuickFormatting 1804M
Creating file system structures.
Format complete.
1847474 KB total disk space.
1835860 KB are available.
X:\I386\SYSTEM32>exit → Exit Windows PE
```

Figure B-5: Partition Creation Commands



**NOTE:**

Use the following commands to check if the partitions were created successfully.

```
X:\I386\SYSTEM32>diskpart
Microsoft DiskPart version 5.2.3790.1830
Copyright (C) 1999-2001 Microsoft Corporation.
On computer: MININT-JUC
DISKPART> sel disk 0
Disk 0 is now the selected disk.
DISKPART> list part
  Partition ###  Type              Size      Offset
-----
  Partition 1    Primary           2000 MB    32 KB
  Partition 2    Primary           1804 MB    2000 MB
DISKPART> exit
```

**Step 6:** Press any key to exit the recovery tool and automatically reboot the system.  
Please continue to the following procedure: Build-up Recovery Partition.

### B.2.3 Install Operating System, Drivers and Applications

Install the operating system onto the unlabelled partition. The partition labeled as "Recovery" is for use by the system recovery tool and should not be used for installing the operating system or any applications.



**NOTE:**

The operating system installation program may offer to reformat the chosen partition. DO NOT format the partition again. The partition has already been formatted and is ready for installing the new operating system.

To install the operating system, insert the operating system installation CD into the optical drive. Restart the computer and follow the installation instructions.

## B.2.4 Build-up Recovery Partition

- Step 1:** Put the recover CD in the optical drive.
- Step 2:** Start the system.
- Step 3:** **Boot the system from recovery CD.** When prompted, press any key to boot from the recovery CD. It will take a while to launch the recovery tool. Please be patient!

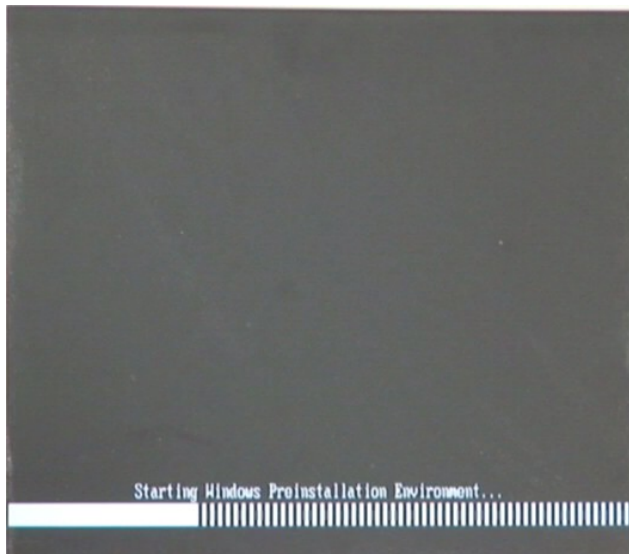

**Figure B-6: Launching the Recovery Tool**

- Step 4:** When the recovery tool setup menu appears, press <2> then <Enter>.

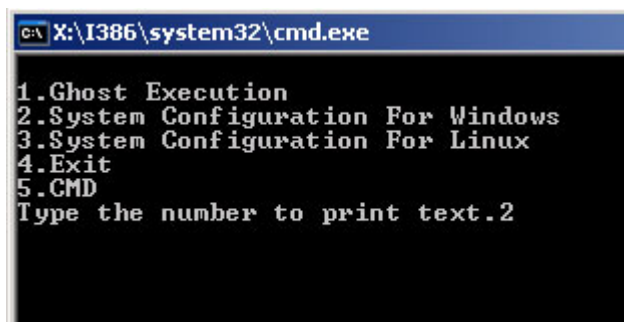
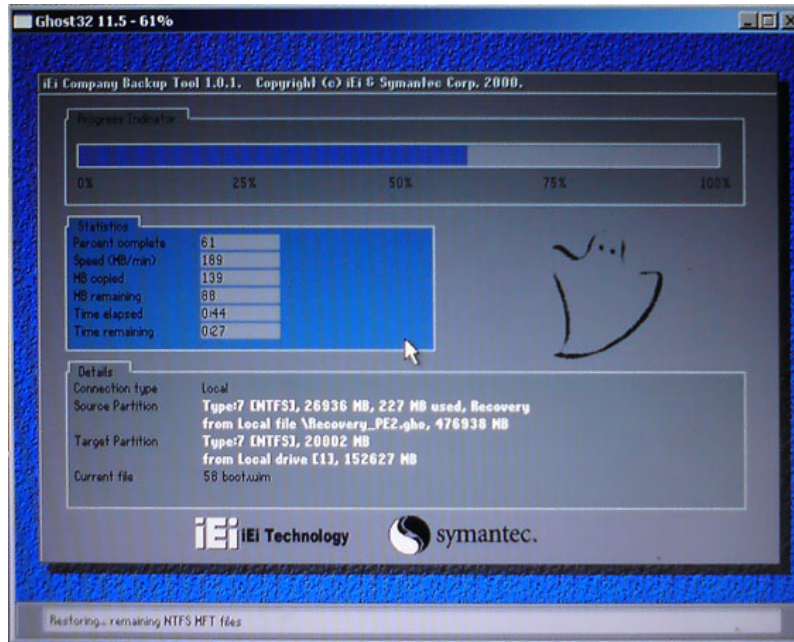

**Figure B-7: System Configuration for Windows**

- Step 5:** The Symantec Ghost window appears and starts configuring the system to build-up a recovery partition. In this process, the partition which is created for

## NOVA-HM551 5.25" SBC

recovery files in **Section B.2.2** is hidden and the recovery tool is saved in this partition.



**Figure B-8: Build-up Recovery Partition**

**Step 6:** After completing the system configuration, press any key in the following window to reboot the system.

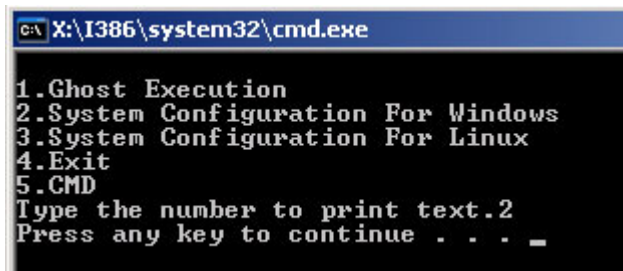

**Figure B-9: Press any key to continue**

**Step 7:** Eject the recovery CD.

## B.2.5 Create Factory Default Image



### NOTE:

Before creating the factory default image, please configure the system to a factory default environment, including driver and application installations.

To create a factory default image, please follow the steps below.

**Step 1:** Turn on the system. When the following screen displays (**Figure B-10**), press the <F3> key to access the recovery tool. The message will display for 10 seconds, please press F3 before the system boots into the operating system.

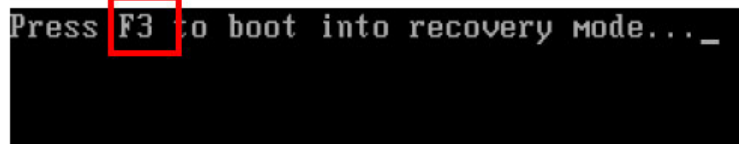

```
Press F3 to boot into recovery mode... _
```

Figure B-10: Press F3 to Boot into Recovery Mode

**Step 2:** The recovery tool menu appears. Type <4> and press <Enter>. (**Figure B-11**)

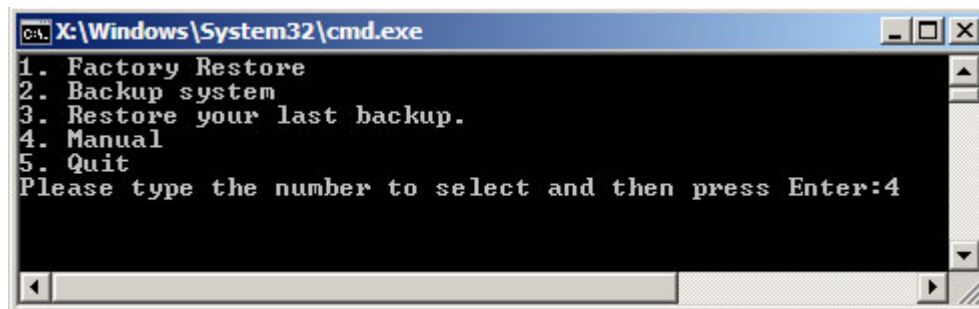

Figure B-11: Recovery Tool Menu

**Step 3:** The About Symantec Ghost window appears. Click **OK** button to continue.

NOVA-HM551 5.25" SBC

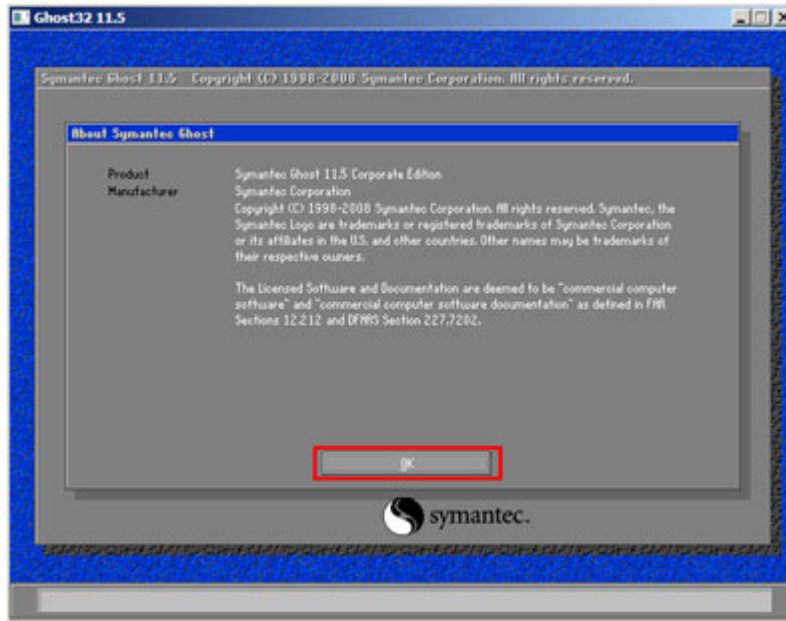

Figure B-12: About Symantec Ghost Window

**Step 4:** Use mouse to navigate to the option shown below (Figure B-13).

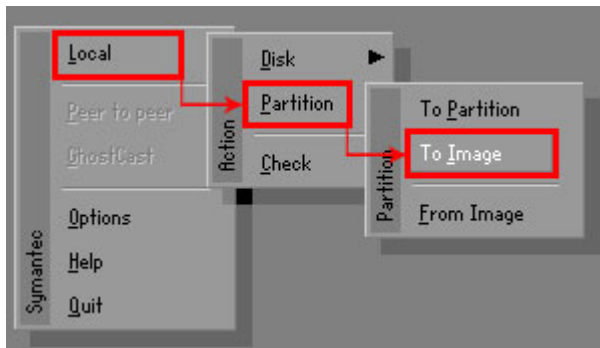
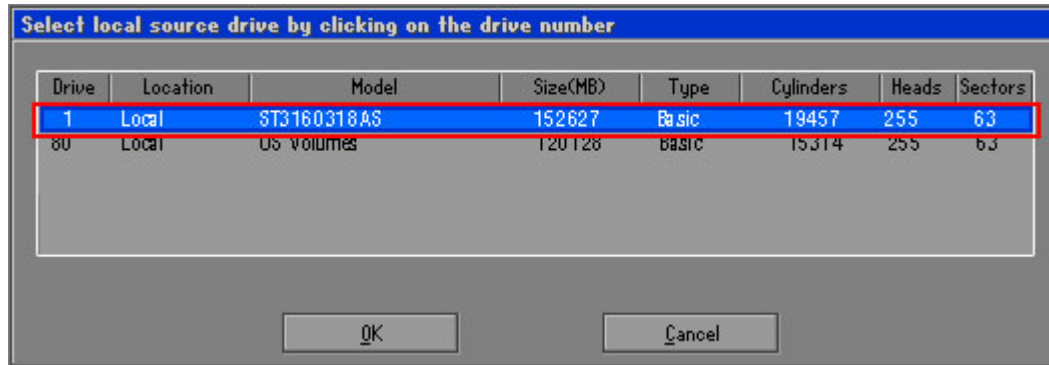

Figure B-13: Symantec Ghost Path

**Step 5:** Select the local source drive (Drive 1) as shown in Figure B-14. Then click OK.



**Figure B-14: Select a Local Source Drive**

**Step 6:** Select a source partition (Part 1) from basic drive as shown in **Figure B-15**. Then click OK.

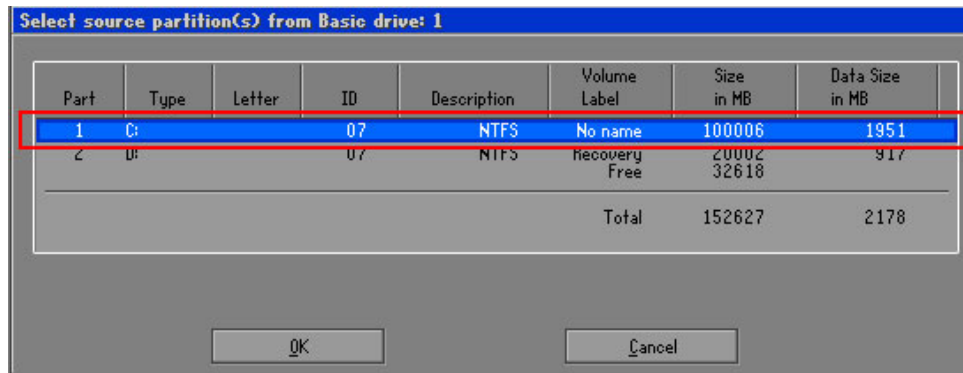

**Figure B-15: Select a Source Partition from Basic Drive**

**Step 7:** Select **1.2: [Recovery] NTFS drive** and enter a file name called **iei** (**Figure B-16**). Click **Save**. The factory default image will then be saved in the selected recovery drive and named **IEI.GHO**.



**WARNING:**

The file name of the factory default image must be **iei.GHO**.



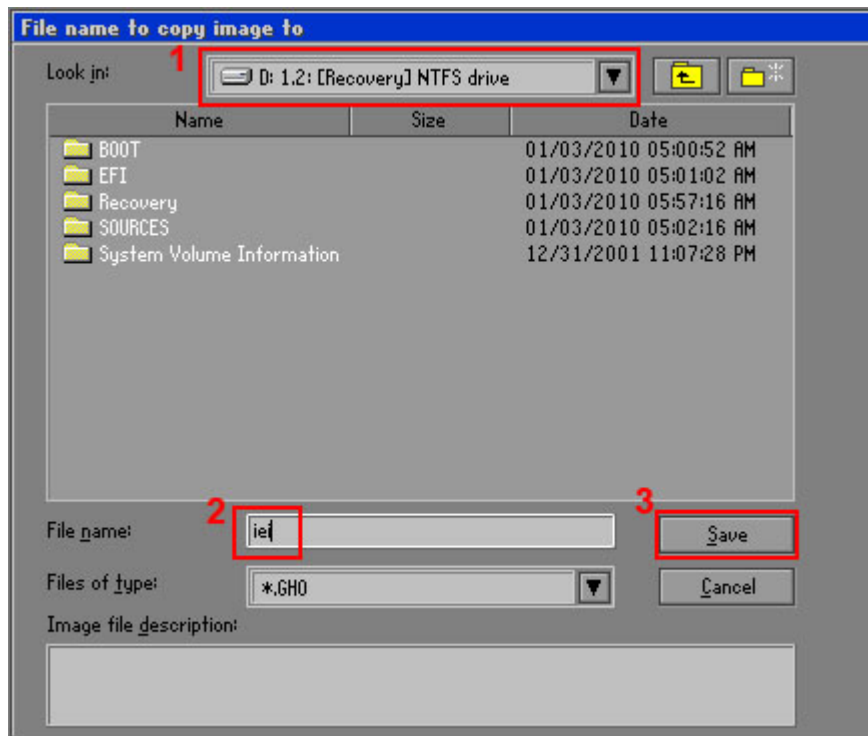

Figure B-16: File Name to Copy Image to

**Step 8:** When the Compress Image screen in **Figure B-17** prompts, click **High** to make the image file smaller.

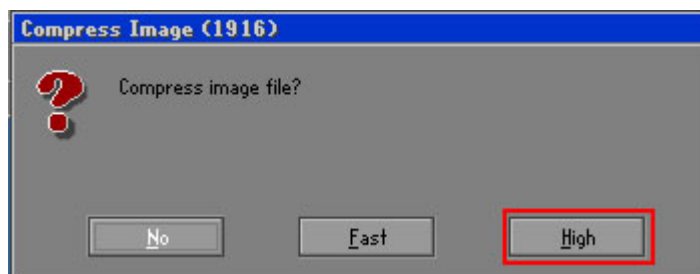
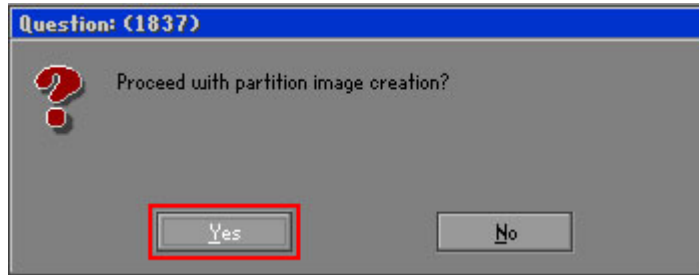

Figure B-17: Compress Image

**Step 9:** The Proceed with partition image creation window appears, click **Yes** to continue.



**Figure B-18: Image Creation Confirmation**

**Step 10:** The Symantec Ghost starts to create the factory default image (**Figure B-19**).

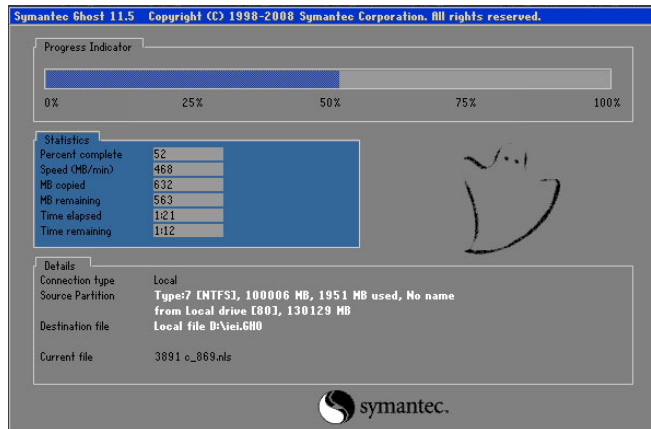

**Figure B-19: Image Creation Process**

**Step 11:** When the image creation completes, a screen prompts as shown in **Figure B-20**.

Click **Continue** and close the Ghost window to exit the program.

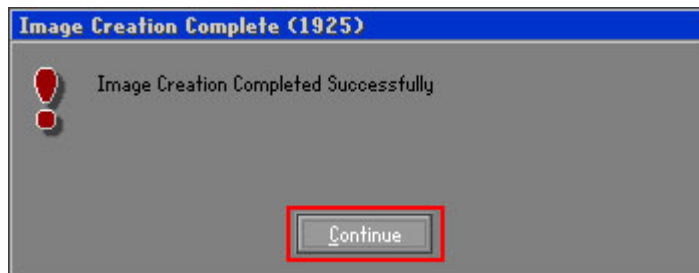

**Figure B-20: Image Creation Complete**

## NOVA-HM551 5.25" SBC

**Step 12:** The recovery tool main menu window is shown as below. Press any key to reboot the system.

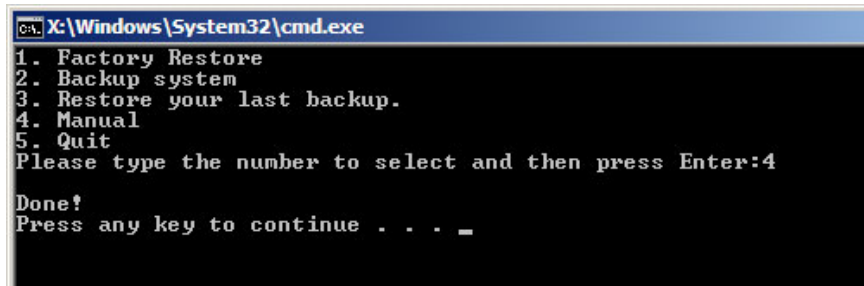

```
C:\Windows\System32\cmd.exe
1. Factory Restore
2. Backup system
3. Restore your last backup.
4. Manual
5. Quit
Please type the number to select and then press Enter:4
Done!
Press any key to continue . . . _
```

Figure B-21: Press Any Key to Continue

### B.3 Setup Procedure for Linux

The initial setup procedures for Linux system are mostly the same with the procedure for Microsoft Windows. Please follow the steps below to setup recovery tool for Linux OS.

**Step 1:** **Hardware and BIOS setup.** Refer to **Section B.2.1.**

**Step 2:** **Install Linux operating system.** Make sure to install GRUB (v0.97 or earlier) MBR type and Ext3 partition type. Leave enough space on the hard drive to create the recover partition later.



#### NOTE:

If the Linux OS is not installed with GRUB (v0.97 or earlier) and Ext3, the Symantec Ghost may not function properly.

---

While installing Linux OS, please create two partitions:

- Partition 1: /
- Partition 2: **SWAP**



**NOTE:**

Please reserve enough space for partition 3 for saving recovery images.

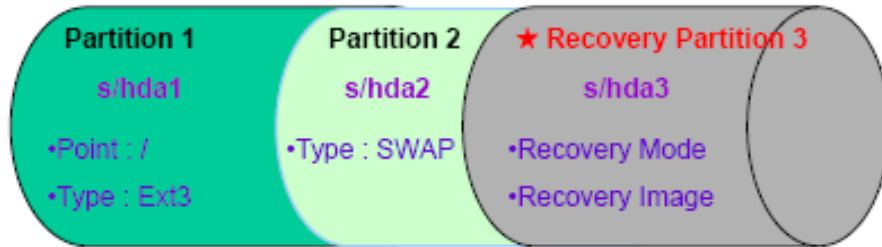

Figure B-22: Partitions for Linux

**Step 3:** Create a recovery partition. Insert the recovery CD into the optical disk drive.

Follow **Step 1 ~ Step 3** described in **Section B.2.2**. Then type the following commands (marked in red) to create a partition for recovery images.

```
system32>diskpart
DISKPART>list vol
DISKPART>sel disk 0
DISKPART>create part pri size= ____
DISKPART>assign letter=N
DISKPART>exit
system32>format N: /fs:ntfs /q /v:Recovery /y
system32>exit
```

**Step 4:** Build-up recovery partition. Press any key to boot from the recovery CD. It will take a while to launch the recovery tool. Please be patient. When the recovery tool setup menu appears, type <3> and press <Enter> (**Figure B-23**). The Symantec Ghost window appears and starts configuring the system to build-up a recovery partition. After completing the system configuration, press any key to reboot the system. Eject the recovery CD.

## NOVA-HM551 5.25" SBC

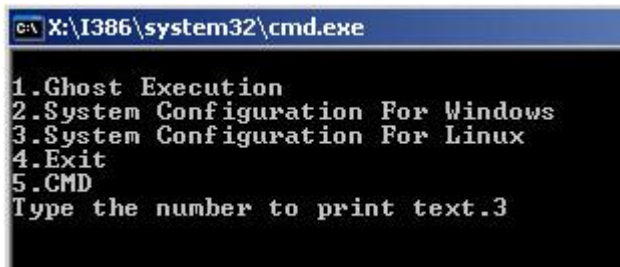

```
C:\X:\I386\system32\cmd.exe
1.Ghost Execution
2.System Configuration For Windows
3.System Configuration For Linux
4.Exit
5.CMD
Type the number to print text.3
```

Figure B-23: System Configuration for Linux

**Step 5:** Access the recovery tool main menu by modifying the “menu.lst”. To first access the recovery tool main menu, the menu.lst must be modified. In Linux system, enter Administrator (root). When prompt appears, type:

```
cd /boot/grub
```

```
vi menu.lst
```

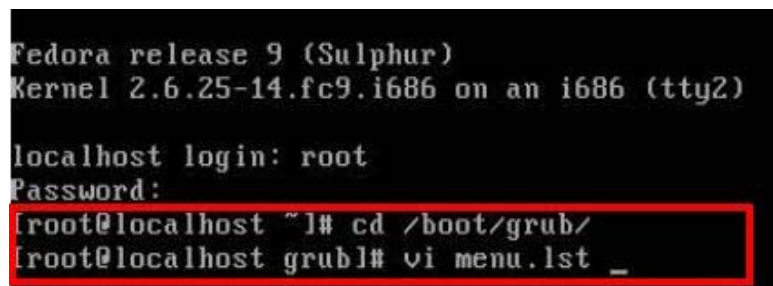

```
Fedora release 9 (Sulphur)
Kernel 2.6.25-14.fc9.i686 on an i686 (tty2)

localhost login: root
Password:
[root@localhost ~]# cd /boot/grub/
[root@localhost grub]# vi menu.lst _
```

Figure B-24: Access menu.lst in Linux (Text Mode)

**Step 6:** Modify the menu.lst as shown below.

```
#boot=/dev/sda
default=0
timeout=10 ← Modify timeout=10
splashimage=(hd0,0)/grub/splash.xpm.gz
hiddenmenu
title Fedora (2.6.25-14.fc9.i686)
    root (hd0,0)
    kernel /vmlinuz-2.6.25-14.fc9.i686 ro root=UUID=10f1acd
ac38b5c78910 rhgb quiet
    initrd /initrd-2.6.25-14.fc9.i686.img

title Recovery Partition
root (hd0,2)
makeactive ← Type command
chainloader +1
```

- Type command:  
**title Recovery Partition**  
**root (hd0,2)**  
**makeactive**  
**chainloader +1**

**Step 7:** The recovery tool menu appears. (Figure B-25)

```
1. Factory Restore
2. Backup system
3. Restore your last backup.
4. Manual
5. Quit
Please type the number to select and then press Enter:
```

**Figure B-25: Recovery Tool Menu**

**Step 8:** Create a factory default image. Follow **Step 2 ~ Step 12** described in **Section B.2.5** to create a factory default image.

## B.4 Recovery Tool Functions

After completing the initial setup procedures as described above, users can access the recovery tool by pressing **<F3>** while booting up the system. The main menu of the recovery tool is shown below.

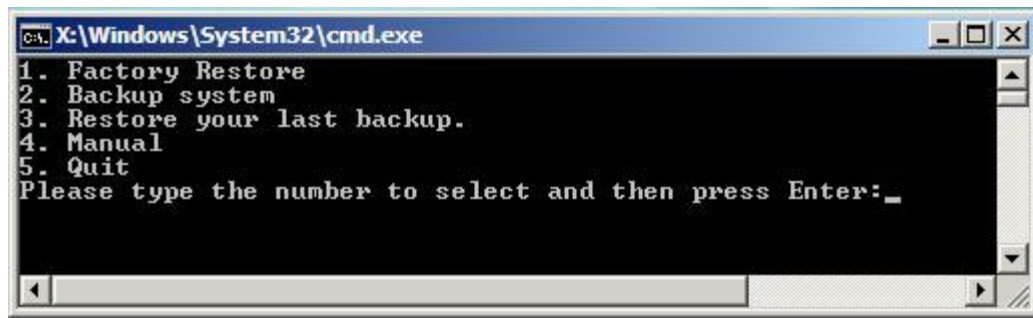

Figure B-26: Recovery Tool Main Menu

The recovery tool has several functions including:

1. **Factory Restore:** Restore the factory default image (iei.GHO) created in **Section B.2.5**.
2. **Backup system:** Create a system backup image (iei\_user.GHO) which will be saved in the hidden partition.
3. **Restore your last backup:** Restore the last system backup image
4. **Manual:** Enter the Symantec Ghost window to configure manually.
5. **Quit:** Exit the recovery tool and restart the system.



**WARNING:**

Please do not turn off the system power during the process of system recovery or backup.



**WARNING:**

All data in the system will be deleted during the system recovery. Please backup the system files before restoring the system (either Factory Restore or Restore Backup).

### B.4.1 Factory Restore

To restore the factory default image, please follow the steps below.

**Step 1:** Type <1> and press <Enter> in the main menu.

**Step 2:** The Symantec Ghost window appears and starts to restore the factory default. A factory default image called **iei.GHO** is created in the hidden Recovery partition.

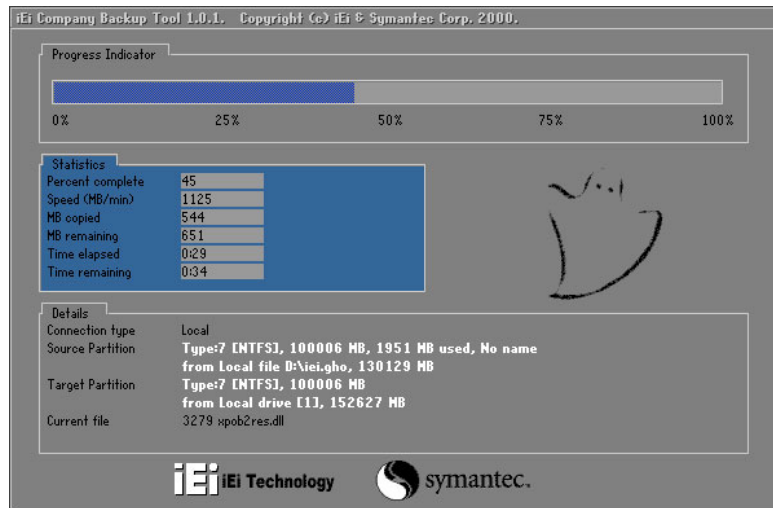

**Figure B-27: Restore Factory Default**

**Step 3:** The screen is shown as in **Figure B-28** when completed. Press any key to reboot the system.

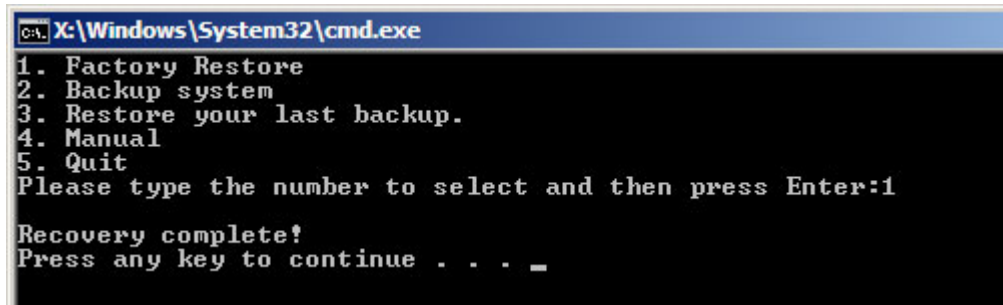

**Figure B-28: Recovery Complete Window**



## NOVA-HM551 5.25" SBC

### B.4.2 Backup System

To backup the system, please follow the steps below.

**Step 1:** Type <2> and press <Enter> in the main menu.

**Step 2:** The Symantec Ghost window appears and starts to backup the system. A backup image called `iei_user.GHO` is created in the hidden Recovery partition.

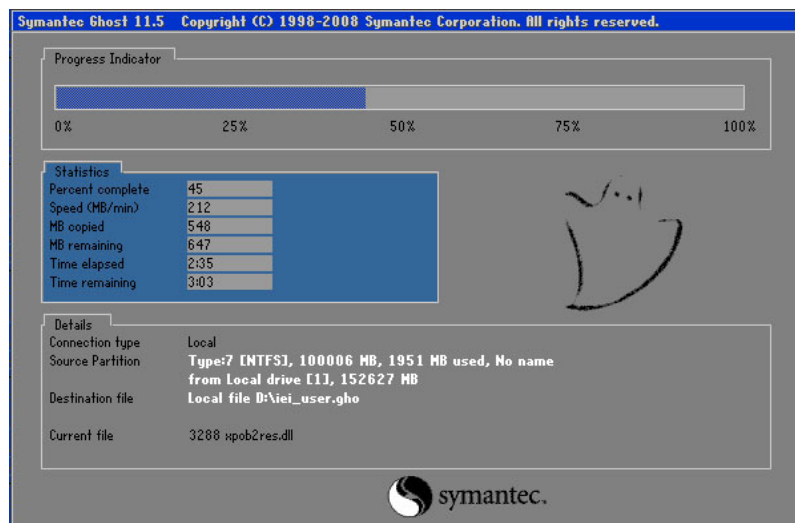

Figure B-29: Backup System

**Step 3:** The screen is shown as in **Figure B-30** when system backup is completed.

Press any key to reboot the system.

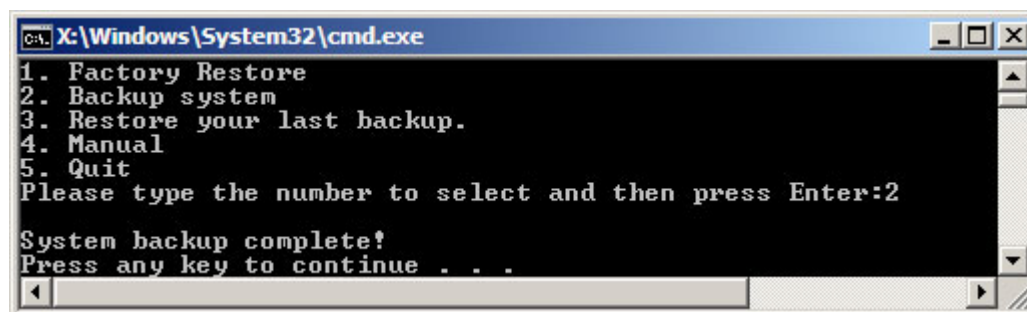

Figure B-30: System Backup Complete Window

### B.4.3 Restore Your Last Backup

To restore the last system backup, please follow the steps below.

**Step 1:** Type <3> and press <Enter> in the main menu.

**Step 2:** The Symantec Ghost window appears and starts to restore the last backup image (iei\_user.GHO).

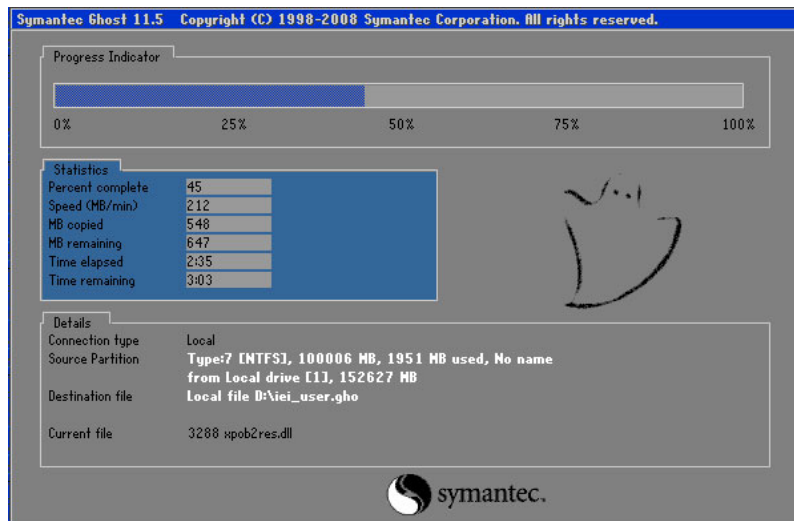

**Figure B-31: Restore Backup**

**Step 3:** The screen is shown as in **Figure B-32** when backup recovery is completed. Press any key to reboot the system.

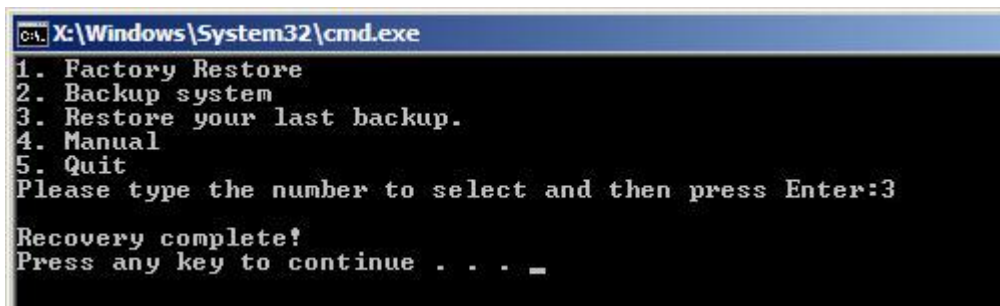

**Figure B-32: Restore System Backup Complete Window**

## NOVA-HM551 5.25" SBC

### B.4.4 Manual

To restore the last system backup, please follow the steps below.

**Step 1:** Type <4> and press <Enter> in the main menu.

**Step 2:** The Symantec Ghost window appears. Use the Ghost program to backup or recover the system manually.

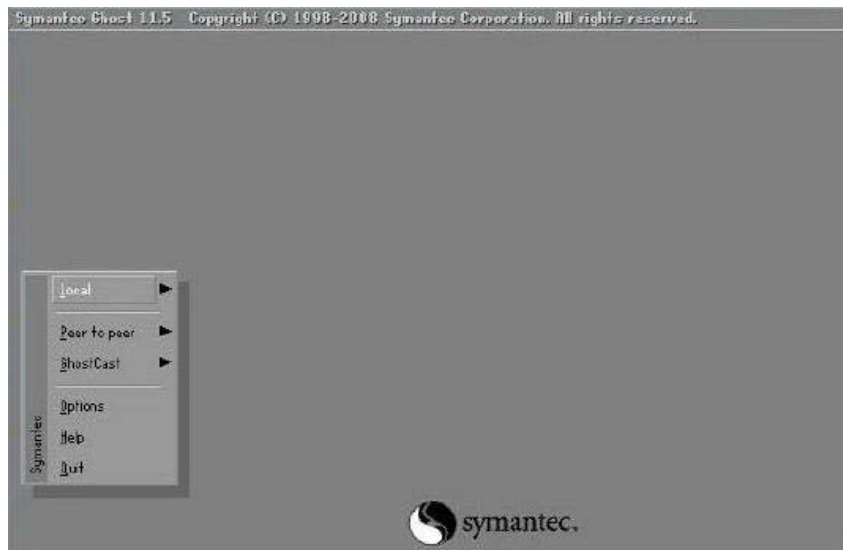

Figure B-33: Symantec Ghost Window

**Step 3:** When backup or recovery is completed, press any key to reboot the system.

## B.5 Other Information

### B.5.1 Using AHCI Mode or ALi M5283 / VIA VT6421A Controller

When the system uses AHCI mode or some specific SATA controllers such as ALi M5283 or VIA VT6421A, the SATA RAID/AHCI driver must be installed before using one key recovery. Please follow the steps below to install the SATA RAID/AHCI driver.

- Step 1:** Copy the SATA RAID/AHCI driver to a floppy disk and insert the floppy disk into a USB floppy disk drive. The SATA RAID/AHCI driver must be especially designed for the on-board SATA controller.
- Step 2:** Connect the USB floppy disk drive to the system.
- Step 3:** Insert the One Key Recovery CD into the system and boot the system from the CD.
- Step 4:** When launching the recovery tool, press <F6>.

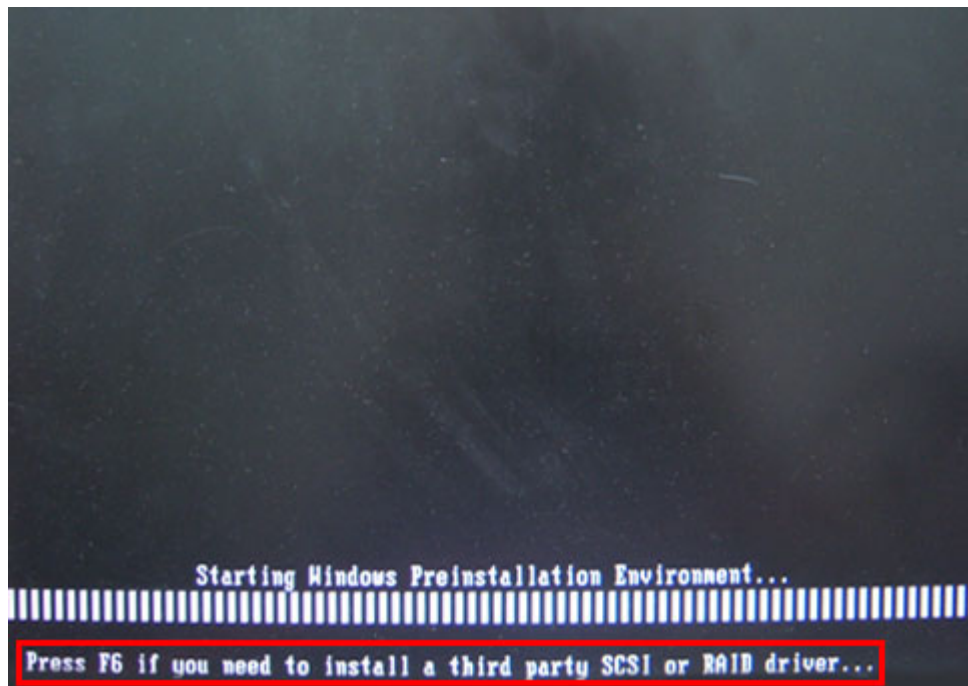

## NOVA-HM551 5.25" SBC

**Step 5:** When the following window appears, press <S> to select "Specify Additional Device".

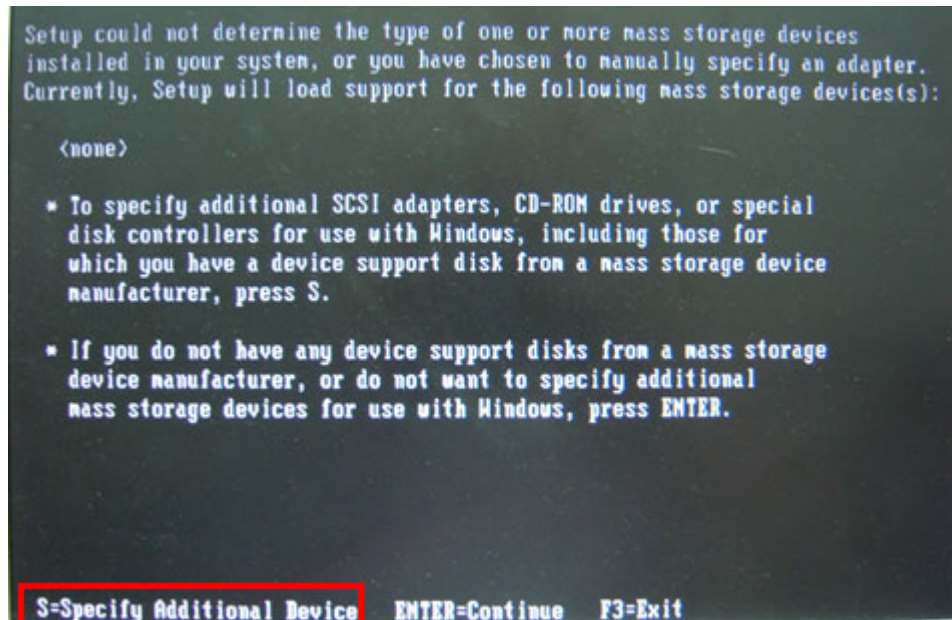

**Step 6:** In the following window, select a SATA controller mode used in the system. Then press <Enter>. The user can now start using the SATA HDD.

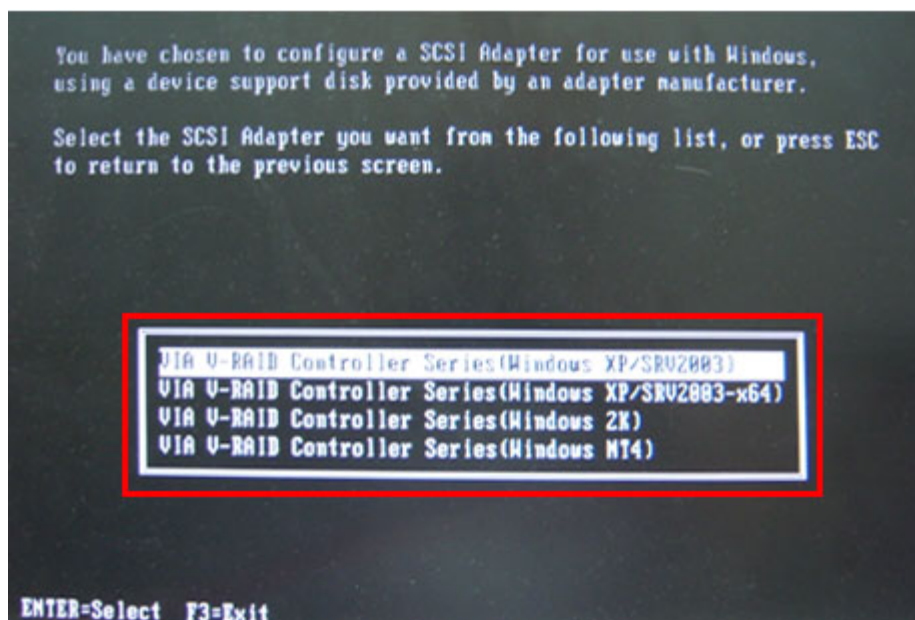

**Step 7:** After pressing <Enter>, the system will get into the recovery tool setup menu.

Continue to follow the setup procedure from **Step 4** in **Section B.2.2 Create Partitions** to finish the whole setup process.

## B.5.2 System Memory Requirement

To be able to access the recovery tool by pressing <F3> while booting up the system, please make sure to have enough system memory. The minimum memory requirement is listed below.

- **Using Award BIOS:** 128 MB system memory
- **Using AMI BIOS:** 512 MB system memory.

Appendix

C

# Terminology

---

AC '97	Audio Codec 97 (AC'97) refers to a codec standard developed by Intel® in 1997.
ACPI	Advanced Configuration and Power Interface (ACPI) is an OS-directed configuration, power management, and thermal management interface.
AHCI	Advanced Host Controller Interface (AHCI) is a SATA Host controller register-level interface.
ATA	The Advanced Technology Attachment (ATA) interface connects storage devices including hard disks and CD-ROM drives to a computer.
APM	The Advanced Power Management (APM) application program interface (API) enables the inclusion of power management in the BIOS.
ARMD	An ATAPI Removable Media Device (ARMD) is any ATAPI device that supports removable media, besides CD and DVD drives.
ASKIR	Amplitude Shift Keyed Infrared (ASKIR) is a form of modulation that represents a digital signal by varying the amplitude (“volume”) of the signal. A low amplitude signal represents a binary 0, while a high amplitude signal represents a binary 1.
BIOS	The Basic Input/Output System (BIOS) is firmware that is first run when the computer is turned on and can be configured by the end user
CODEC	The Compressor-Decompressor (CODEC) encodes and decodes digital audio data on the system.
CMOS	Complimentary metal-oxide-conductor is a type of integrated circuit used in chips like static RAM and microprocessors.
COM	COM is used to refer to serial ports. Serial ports offer serial communication to expansion devices. The serial port on a personal



## NOVA-HM551 5.25" SBC

	computer is usually a male DE-9 connector.
DAC	The Digital-to-Analog Converter (DAC) converts digital signals to analog signals.
DDR	Double Data Rate refers to a data bus transferring data on both the rising and falling edges of the clock signal.
DMA	Direct Memory Access (DMA) enables some peripheral devices to bypass the system processor and communicate directly with the system memory.
DIMM	Dual Inline Memory Modules are a type of RAM that offer a 64-bit data bus and have separate electrical contacts on each side of the module.
EHCI	The Enhanced Host Controller Interface (EHCI) specification is a register-level interface description for USB 2.0 Host Controllers.
GbE	Gigabit Ethernet (GbE) is an Ethernet version that transfers data at 1.0 Gbps and complies with the IEEE 802.3-2005 standard.
GPIO	General purpose input
IrDA	Infrared Data Association (IrDA) specify infrared data transmission protocols used to enable electronic devices to wirelessly communicate with each other.
L1 Cache	The Level 1 Cache (L1 Cache) is a small memory cache built into the system processor.
L2 Cache	The Level 2 Cache (L2 Cache) is an external processor memory cache.
LVDS	Low-voltage differential signaling (LVDS) is a dual-wire, high-speed differential electrical signaling system commonly used to connect LCD displays to a computer.
MAC	The Media Access Control (MAC) protocol enables several terminals or network nodes to communicate in a LAN, or other multipoint networks.

PCIe	PCI Express (PCIe) is a communications bus that uses dual data lines for full-duplex (two-way) serial (point-to-point) communications between the SBC components and/or expansion cards and the SBC chipsets. Each line has a 2.5 Gbps data transmission rate and a 250 MBps sustained data transfer rate.
POST	The Power-on Self Test (POST) is the pre-boot actions the system performs when the system is turned-on.
QVGA	Quarter Video Graphics Array (QVGA) refers to a display with a resolution of 320 x 240 pixels.
RAM	Random Access Memory (RAM) is a form of storage used in computer. RAM is volatile memory, so it loses its data when power is lost. RAM has very fast data transfer rates compared to other storage like hard drives.
SATA	Serial ATA (SATA) is a serial communications bus designed for data transfers between storage devices and the computer chipsets. The SATA bus has transfer speeds up to 1.5 Gbps and the SATA 3Gb/s bus has data transfer speeds of up to 3.0 Gbps.
S.M.A.R.T	Self Monitoring Analysis and Reporting Technology (S.M.A.R.T) refers to automatic status checking technology implemented on hard disk drives.
UART	Universal Asynchronous Receiver-transmitter (UART) is responsible for asynchronous communications on the system and manages the system's serial communication (COM) ports.
UHCI	The Universal Host Controller Interface (UHCI) specification is a register-level interface description for USB 1.1 Host Controllers.
USB	The Universal Serial Bus (USB) is an external bus standard for interfacing devices. USB 1.1 supports 12Mbps data transfer rates, while

## NOVA-HM551 5.25" SBC

USB 2.0 supports 480Mbps data transfer rates.

### VGA

The Video Graphics Array (VGA) is a graphics display system developed by IBM.

Appendix

D

# Watchdog Timer

---



**NOTE:**

The following discussion applies to DOS environment. IEI support is contacted or the IEI website visited for specific drivers for more sophisticated operating systems, e.g., Windows and Linux.

The Watchdog Timer is provided to ensure that standalone systems can always recover from catastrophic conditions that cause the CPU to crash. This condition may have occurred by external EMI or a software bug. When the CPU stops working correctly, Watchdog Timer either performs a hardware reset (cold boot) or a Non-Maskable Interrupt (NMI) to bring the system back to a known state.

A BIOS function call (INT 15H) is used to control the Watchdog Timer:

**INT 15H:**

<b>AH – 6FH Sub-function:</b>	
AL – 2:	Sets the Watchdog Timer's period.
BL:	Time-out value (Its unit-second is dependent on the item "Watchdog Timer unit select" in CMOS setup).

**Table D-1: AH-6FH Sub-function**

Call sub-function 2 to set the time-out period of Watchdog Timer first. If the time-out value is not zero, the Watchdog Timer starts counting down. While the timer value reaches zero, the system resets. To ensure that this reset condition does not occur, calling sub-function 2 must periodically refresh the Watchdog Timer. However, the Watchdog timer is disabled if the time-out value is set to zero.

A tolerance of at least 10% must be maintained to avoid unknown routines within the operating system (DOS), such as disk I/O that can be very time-consuming.



**NOTE:**

When exiting a program it is necessary to disable the Watchdog Timer, otherwise the system resets.

**Example program:**

**; INITIAL TIMER PERIOD COUNTER**

;

W\_LOOP:

MOV AX, 6F02H ;setting the time-out value

MOV BL, 30H ;time-out value is 48 seconds

INT 15H

;

**; ADD THE APPLICATION PROGRAM HERE**

;

CMP EXIT\_AP, 1 ;is the application over?

JNE W\_LOOP ;No, restart the application

MOV AX, 6F02H ;disable Watchdog Timer

MOV BL, 0 ;

INT 15H

;

**; EXIT ;**

Appendix

E

# Hazardous Materials Disclosure

---

## **E.1 Hazardous Material Disclosure Table for IPB Products Certified as RoHS Compliant Under 2002/95/EC Without Mercury**

The details provided in this appendix are to ensure that the product is compliant with the Peoples Republic of China (China) RoHS standards. The table below acknowledges the presences of small quantities of certain materials in the product, and is applicable to China RoHS only.

A label will be placed on each product to indicate the estimated “Environmentally Friendly Use Period” (EFUP). This is an estimate of the number of years that these substances would “not leak out or undergo abrupt change.” This product may contain replaceable sub-assemblies/components which have a shorter EFUP such as batteries and lamps. These components will be separately marked.

Please refer to the table on the next page.



# NOVA-HM551 5.25" SBC

Part Name	Toxic or Hazardous Substances and Elements					
	Lead (Pb)	Mercury (Hg)	Cadmium (Cd)	Hexavalent Chromium (CR(VI))	Polybrominated Biphenyls (PBB)	Polybrominated Diphenyl Ethers (PBDE)
Housing	X	O	O	O	O	X
Display	X	O	O	O	O	X
Printed Circuit Board	X	O	O	O	O	X
Metal Fasteners	X	O	O	O	O	O
Cable Assembly	X	O	O	O	O	X
Fan Assembly	X	O	O	O	O	X
Power Supply Assemblies	X	O	O	O	O	X
Battery	O	O	O	O	O	O

O: This toxic or hazardous substance is contained in all of the homogeneous materials for the part is below the limit requirement in SJ/T11363-2006

X: This toxic or hazardous substance is contained in at least one of the homogeneous materials for this part is above the limit requirement in SJ/T11363-2006

此附件旨在确保本产品符合中国 RoHS 标准。以下表格标示此产品中某有毒物质的含量符合中国 RoHS 标准规定的限量要求。

本产品上会附有“环境友好使用期限”的标签，此期限是估算这些物质“不会有泄漏或突变”的年限。本产品可能包含有较短的环境友好使用期限的可替换元件，像是电池或灯管，这些元件将会单独标示出来。

部件名称	有毒有害物质或元素					
	铅 (Pb)	汞 (Hg)	镉 (Cd)	六价铬 (CR(VI))	多溴联苯 (PBB)	多溴二苯醚 (PBDE)
壳体	X	○	○	○	○	X
显示	X	○	○	○	○	X
印刷电路板	X	○	○	○	○	X
金属螺帽	X	○	○	○	○	○
电缆组装	X	○	○	○	○	X
风扇组装	X	○	○	○	○	X
电力供应组装	X	○	○	○	○	X
电池	○	○	○	○	○	○

○: 表示该有毒有害物质在该部件所有物质材料中的含量均在 SJ/T11363-2006 标准规定的限量要求以下。  
X: 表示该有毒有害物质至少在该部件的某一均质材料中的含量超出 SJ/T11363-2006 标准规定的限量要求。