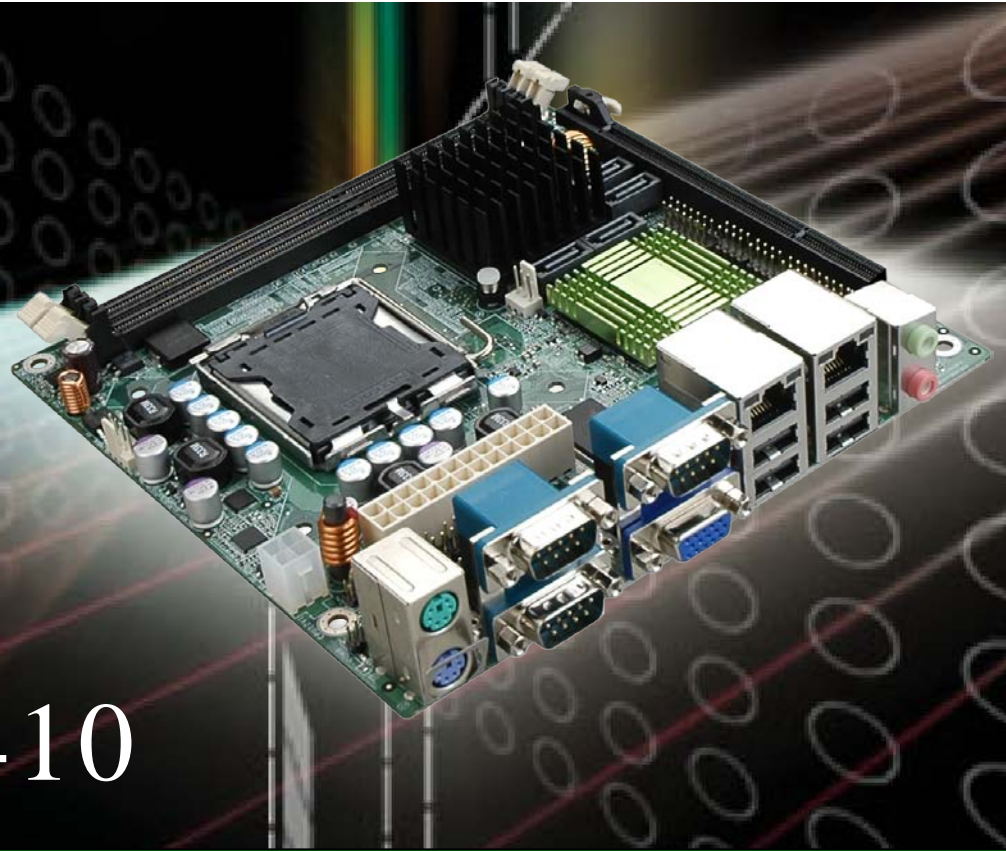




IEI Technology Corp.



MODEL:  
**KINO-G410**

Mini-ITX Motherboard for Intel® Core™2 Duo/Quad/Extreme CPU, 800/1066/1333 MHz FSB, DDR3, VGA, LAN, SATA 3Gb/s, PCIe x16, USB, HD Audio, RoHS Compliant

## User Manual

Rev. 2.00 – 6 March, 2012



# Revision

Date	Version	Changes
6 March, 2012	2.00	Update the version number
20 January, 2012	1.03	Update the BIOS section
17 August, 2011	1.02	Modified Figure 4-9
4 March, 2011	1.01	Modified VGA to LVDS connector pinouts ( <b>Table 3-16</b> )
13 September, 2010	1.00	Initial release

# Copyright

---

## COPYRIGHT NOTICE

The information in this document is subject to change without prior notice in order to improve reliability, design and function and does not represent a commitment on the part of the manufacturer.

In no event will the manufacturer be liable for direct, indirect, special, incidental, or consequential damages arising out of the use or inability to use the product or documentation, even if advised of the possibility of such damages.

This document contains proprietary information protected by copyright. All rights are reserved. No part of this manual may be reproduced by any mechanical, electronic, or other means in any form without prior written permission of the manufacturer.

## TRADEMARKS

All registered trademarks and product names mentioned herein are used for identification purposes only and may be trademarks and/or registered trademarks of their respective owners.

# Table of Contents

---

<b>1 INTRODUCTION.....</b>	<b>1</b>
1.1 INTRODUCTION.....	2
1.2 BENEFITS .....	2
1.3 FEATURES.....	2
1.4 CONNECTORS .....	3
1.5 DIMENSIONS.....	4
1.6 DATA FLOW .....	5
1.7 TECHNICAL SPECIFICATIONS .....	6
<b>2 PACKING LIST.....</b>	<b>8</b>
2.1 ANTI-STATIC PRECAUTIONS .....	9
2.2 UNPACKING PRECAUTIONS.....	9
2.3 PACKING LIST.....	10
2.4 OPTIONAL ITEMS .....	11
<b>3 CONNECTORS .....</b>	<b>13</b>
3.1 PERIPHERAL INTERFACE CONNECTORS.....	14
3.1.1 <i>Layout</i> .....	14
3.1.2 <i>Peripheral Interface Connectors</i> .....	15
3.1.3 <i>External Interface Panel Connectors</i> .....	15
3.2 INTERNAL PERIPHERAL CONNECTORS .....	16
3.2.1 <i>Battery Connector</i> .....	16
3.2.2 <i>CPU Fan Connector</i> .....	17
3.2.3 <i>System Fan Connector</i> .....	18
3.2.4 <i>CPU Power Input Connector</i> .....	18
3.2.5 <i>Digital I/O Connector</i> .....	19
3.2.6 <i>Front Panel Connector</i> .....	20
3.2.7 <i>Memory Slot</i> .....	21
3.2.8 <i>Parallel Port Connector</i> .....	21
3.2.9 <i>Power Connector</i> .....	23
3.2.10 <i>RS-232 Serial Port Connector</i> .....	24

3.2.11 RS-232/422/485 Serial Port Connector .....	25
3.2.12 SATA Drive Connectors .....	26
3.2.13 SMBus Connector .....	26
3.2.14 SPI Flash Connector.....	27
3.2.15 USB Connectors.....	28
3.2.16 VGA to LVDS Connector.....	29
3.3 EXTERNAL PERIPHERAL INTERFACE CONNECTOR PANEL .....	30
3.3.1 Audio Connector .....	30
3.3.2 Keyboard/Mouse Connector .....	31
3.3.3 LAN Connector .....	31
3.3.4 Serial Port Connectors (COM1, COM2 and COM3).....	32
3.3.5 USB Connector .....	33
3.3.6 VGA Connector.....	33
<b>4 INSTALLATION .....</b>	<b>35</b>
4.1 ANTI-STATIC PRECAUTIONS .....	36
4.2 INSTALLATION CONSIDERATIONS.....	36
4.3 BASIC INSTALLATION .....	38
4.3.1 CPU Installation.....	38
4.3.2 Cooling Kit Installation .....	41
4.3.3 DIMM Installation .....	43
4.3.4 Motherboard Installation.....	43
4.4 JUMPER SETTINGS .....	44
4.4.1 Clear CMOS Jumper.....	44
4.4.2 COM 6 Function Select Jumper.....	45
4.5 INTERNAL PERIPHERAL DEVICE CONNECTIONS.....	46
4.5.1 SATA Drive Connection .....	46
4.5.2 USB Cable (Dual Port) with Slot Bracket .....	48
4.6 EXTERNAL PERIPHERAL INTERFACE CONNECTION .....	49
4.6.1 Audio Connector .....	49
4.6.2 PS/2 Keyboard and Mouse Connection .....	50
4.6.3 LAN Connection.....	51
4.6.4 Serial Device Connection .....	52
4.6.5 USB Device Connection.....	53
4.6.6 VGA Monitor Connection .....	54

4.7 SOFTWARE INSTALLATION .....	55
<b>5 BIOS .....</b>	<b>56</b>
5.1 INTRODUCTION.....	57
5.1.1 Starting Setup.....	57
5.1.2 Using Setup .....	57
5.1.3 Getting Help.....	58
5.1.4 Unable to Reboot after Configuration Changes .....	58
5.1.5 BIOS Menu Bar.....	58
5.2 MAIN.....	59
5.3 ADVANCED.....	60
5.3.1 CPU Configuration.....	61
5.3.2 IDE Configuration .....	61
5.3.2.1 IDE Master, IDE Slave .....	63
5.3.3 Super IO Configuration .....	68
5.3.4 Hardware Health Configuration.....	73
5.3.5 Power Configuration .....	76
5.3.5.1 ACPI configuration .....	77
5.3.5.2 APM Configuration.....	77
5.3.6 Remote Access Configuration .....	79
5.3.7 USB Configuration.....	82
5.4 PCI/PNP.....	83
5.5 BOOT.....	86
5.5.1 Boot Settings Configuration.....	86
5.6 SECURITY.....	88
5.7 CHIPSET .....	90
5.7.1 North Bridge Chipset Configuration .....	90
5.7.2 South Bridge Chipset Configuration.....	92
5.8 EXIT .....	93
<b>A BIOS OPTIONS .....</b>	<b>95</b>
<b>B TERMINOLOGY.....</b>	<b>99</b>
<b>C ONE KEY RECOVERY.....</b>	<b>103</b>
C.1 ONE KEY RECOVERY INTRODUCTION .....	104
C.1.1 System Requirement .....	105

C.1.2 Supported Operating System.....	106
C.2 SETUP PROCEDURE FOR WINDOWS.....	107
C.2.1 Hardware and BIOS Setup.....	107
C.2.2 Create Partitions.....	108
C.2.3 Install Operating System, Drivers and Applications.....	111
C.2.4 Build-up Recovery Partition.....	112
C.2.5 Create Factory Default Image.....	114
C.3 SETUP PROCEDURE FOR LINUX.....	119
C.4 RECOVERY TOOL FUNCTIONS.....	122
C.4.1 Factory Restore.....	124
C.4.2 Backup System.....	125
C.4.3 Restore Your Last Backup.....	126
C.4.4 Manual.....	127
C.5 OTHER INFORMATION.....	128
C.5.1 Using AHCI Mode or ALi M5283 / VIA VT6421A Controller.....	128
C.5.2 System Memory Requirement.....	130
<b>D WATCHDOG TIMER.....</b>	<b>131</b>
<b>E DIGITAL I/O INTERFACE.....</b>	<b>134</b>
E.1 INTRODUCTION.....	135
E.2 DIO CONNECTOR PINOUTS.....	135
E.3 ASSEMBLY LANGUAGE EXAMPLE.....	135
<b>F HAZARDOUS MATERIALS DISCLOSURE.....</b>	<b>136</b>
F.1 HAZARDOUS MATERIALS DISCLOSURE TABLE FOR IPB PRODUCTS CERTIFIED AS ROHS COMPLIANT UNDER 2002/95/EC WITHOUT MERCURY.....	137

# List of Figures

---

Figure 1-1: KINO-G410 .....	2
Figure 1-2: Connectors .....	3
Figure 1-3: Dimensions (mm) .....	4
Figure 1-4: Data Flow Diagram .....	5
Figure 3-1: Connectors and Jumpers .....	14
Figure 3-2: Battery Connector Location .....	16
Figure 3-3: CPU Fan Connector Location .....	17
Figure 3-4: CPU Fan Connector Location .....	18
Figure 3-5: CPU Power Input Connector Location .....	19
Figure 3-6: Digital I/O Connector Locations .....	19
Figure 3-7: Front Panel Connector Location .....	20
Figure 3-8: Memory Card Slot Location .....	21
Figure 3-9: Parallel Port Connector Location .....	22
Figure 3-10: Power Connector Location .....	23
Figure 3-11: Serial Port Connector Location .....	24
Figure 3-12: RS-232/422/485 Serial Port Connector Location .....	25
Figure 3-13: SATA Drive Connector Location .....	26
Figure 3-14: SMBus Connector Location .....	27
Figure 3-15: SPI Flash Connector .....	27
Figure 3-16: USB Connector Pinout Locations .....	28
Figure 3-17: VGA to LVDS Connector Location .....	29
Figure 3-18: External Peripheral Interface Connector .....	30
Figure 3-19: Audio Connector .....	30
Figure 3-20: PS/2 Pinout and Configuration .....	31
Figure 3-21: Serial Port Pinouts .....	32
Figure 3-22: VGA Connector .....	33
Figure 4-1: Intel LGA775 Socket .....	38
Figure 4-2: Remove Protective Cover .....	39
Figure 4-3: CPU Socket Load Plate .....	39
Figure 4-4: Insert the Socket LGA775 CPU .....	40



Figure 4-5: Cooling Kits .....	41
Figure 4-6: Securing the Heat sink to the KINO-G410 .....	42
Figure 4-7: DIMM Installation.....	43
Figure 4-8: Clear BIOS Jumper Location .....	45
Figure 4-9: COM 6 Function Select Jumper Location.....	46
Figure 4-10: SATA Drive Cable Connection.....	47
Figure 4-11: SATA Power Drive Connection.....	48
Figure 4-12: Dual USB Cable Connection .....	49
Figure 4-13: Audio Connector .....	50
Figure 4-14: PS/2 Keyboard/Mouse Connector .....	51
Figure 4-15: LAN Connection .....	52
Figure 4-16: Serial Device Connector.....	53
Figure 4-17: USB Connector.....	54
Figure 4-18: VGA Connector .....	55
Figure C-1: IEI One Key Recovery Tool Menu .....	104
Figure C-2: Launching the Recovery Tool .....	108
Figure C-3: Recovery Tool Setup Menu .....	109
Figure C-4: Command Mode.....	109
Figure C-5: Partition Creation Commands.....	110
Figure C-6: Launching the Recovery Tool .....	112
Figure C-7: System Configuration for Windows .....	112
Figure C-8: Build-up Recovery Partition .....	113
Figure C-9: Press any key to continue .....	113
Figure C-10: Press F3 to Boot into Recovery Mode.....	114
Figure C-11: Recovery Tool Menu .....	114
Figure C-12: About Symantec Ghost Window.....	115
Figure C-13: Symantec Ghost Path .....	115
Figure C-14: Select a Local Source Drive .....	116
Figure C-15: Select a Source Partition from Basic Drive .....	116
Figure C-16: File Name to Copy Image to .....	117
Figure C-17: Compress Image.....	117
Figure C-18: Image Creation Confirmation .....	118
Figure C-19: Image Creation Process.....	118
Figure C-20: Image Creation Complete .....	118
Figure C-21: Press Any Key to Continue .....	119

Figure C-22: Partitions for Linux.....	120
Figure C-23: System Configuration for Linux.....	121
Figure C-24: Access menu.lst in Linux (Text Mode).....	121
Figure C-25: Recovery Tool Menu .....	122
Figure C-26: Recovery Tool Main Menu .....	123
Figure C-27: Restore Factory Default.....	124
Figure C-28: Recovery Complete Window .....	124
Figure C-29: Backup System.....	125
Figure C-30: System Backup Complete Window .....	125
Figure C-31: Restore Backup .....	126
Figure C-32: Restore System Backup Complete Window .....	126
Figure C-33: Symantec Ghost Window .....	127

# List of Tables

<b>Table 1-1: Technical Specifications</b> .....	<b>7</b>
<b>Table 2-1: Packing List</b> .....	<b>10</b>
<b>Table 2-2: Optional Items</b> .....	<b>12</b>
<b>Table 3-1: Internal Peripheral Connectors</b> .....	<b>15</b>
<b>Table 3-2: External Peripheral Connectors</b> .....	<b>16</b>
<b>Table 3-3: Battery Connector Pinouts</b> .....	<b>17</b>
<b>Table 3-4: CPU Fan Connector Pinouts</b> .....	<b>17</b>
<b>Table 3-5: CPU Fan Connector Pinouts</b> .....	<b>18</b>
<b>Table 3-6: CPU Power Input Connector Pinouts</b> .....	<b>19</b>
<b>Table 3-7: Digital I/O Connector Pinouts</b> .....	<b>20</b>
<b>Table 3-8: Front Panel Connector Pinouts</b> .....	<b>21</b>
<b>Table 3-9: Parallel Port Connector Pinouts</b> .....	<b>22</b>
<b>Table 3-10: Power Connector Pinouts</b> .....	<b>23</b>
<b>Table 3-11: Serial Port Connector Pinouts</b> .....	<b>24</b>
<b>Table 3-12: RS-232/422/485 Serial Port Connector Pinouts</b> .....	<b>25</b>
<b>Table 3-13: SMBus Connector Pinouts</b> .....	<b>27</b>
<b>Table 3-14: SPI Flash Connector</b> .....	<b>28</b>
<b>Table 3-15: USB Port Connector Pinouts</b> .....	<b>28</b>
<b>Table 3-16: VGA to LVDS Connector Pinouts</b> .....	<b>29</b>
<b>Table 3-17: Keyboard Connector Pinouts</b> .....	<b>31</b>
<b>Table 3-18: LAN Pinouts</b> .....	<b>32</b>
<b>Table 3-19: Serial Port Pinouts</b> .....	<b>32</b>
<b>Table 3-20: USB Port Pinouts</b> .....	<b>33</b>
<b>Table 3-21: VGA Connector Pinouts</b> .....	<b>34</b>
<b>Table 4-1: Jumpers</b> .....	<b>44</b>
<b>Table 4-2: Clear BIOS Jumper Settings</b> .....	<b>45</b>
<b>Table 4-3: COM 6 Function Select Jumper Settings</b> .....	<b>45</b>
<b>Table 5-1: BIOS Navigation Keys</b> .....	<b>58</b>

# BIOS Menus

---

BIOS Menu 1: Main .....	59
BIOS Menu 2: Advanced .....	60
BIOS Menu 3: CPU Configuration .....	61
BIOS Menu 4: IDE Configuration .....	62
BIOS Menu 5: IDE Master and IDE Slave Configuration .....	63
BIOS Menu 6: Super IO Configuration .....	68
BIOS Menu 7: Hardware Health Configuration .....	73
BIOS Menu 8: Power Configuration .....	76
BIOS Menu 9: ACPI Configuration .....	77
BIOS Menu 10: Advanced Power Management Configuration .....	78
BIOS Menu 11: Remote Access Configuration .....	79
BIOS Menu 12: USB Configuration .....	82
BIOS Menu 13: PCI/PnP Configuration .....	84
BIOS Menu 14: Boot .....	86
BIOS Menu 15: Boot Settings Configuration .....	86
BIOS Menu 16: Security .....	88
BIOS Menu 17: Chipset .....	90
BIOS Menu 18: North Bridge Chipset Configuration .....	91
BIOS Menu 19: South Bridge Chipset Configuration .....	92
BIOS Menu 20: Exit .....	93

Chapter

1

# Introduction

---

## 1.1 Introduction



**Figure 1-1: KINO-G410**

The KINO-G410 is a Mini-ITX motherboard with an 800/1066/1333 MHz front side bus. The LGA775 socket accepts Intel® Core™2 Duo/Quad/Extreme processors and the card supports two DDR3 DIMMs up to 2.0 GB each (4.0 GB total). The KINO-G410 includes VGA output and an optional 24-bit LVDS output. One PCIe x16 expansion card may be added. Other features include four SATA 3Gb/s, dual Gigabit LAN, digital I/O, five RS-232 serial ports, one RS-232/422/485 serial ports, one parallel port, audio jacks and eight USB ports.

## 1.2 Benefits

Some of the KINO-G410 motherboard benefits include:

- Powerful graphics
- Staying connected with both wired LAN connections
- Speedy running of multiple programs and applications

## 1.3 Features

Some of the KINO-G410 motherboard features are listed below:

- Mini-ITX form factor

## KINO-G410 Mini-ITX Motherboard

- RoHS compliant
- LGA775 CPU socket
- Supports two DDR3 DIMMs
- Two Gigabit Ethernet connectors
- Four SATA connectors
- Eight USB ports
- Six serial ports
- Support 24-bit LVDS by the optional VGA to LVDS converter module

### 1.4 Connectors

The connectors on the KINO-G410 are shown in the figure below.

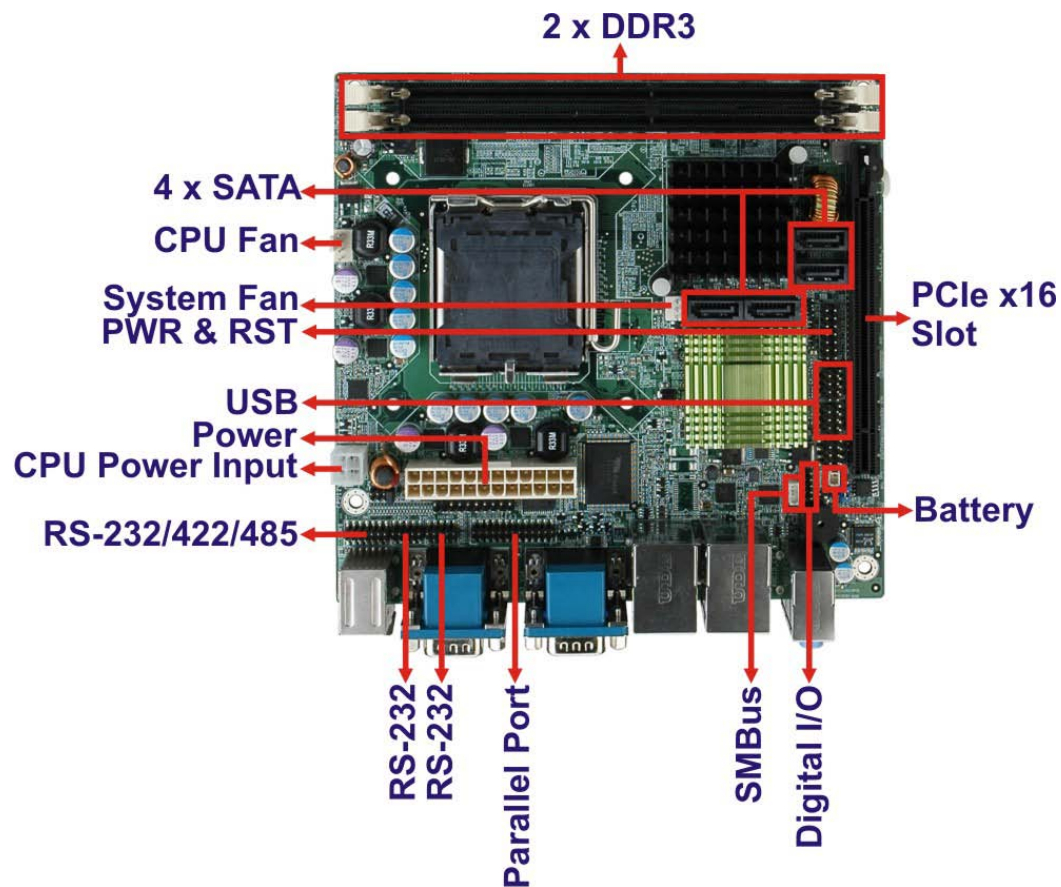


Figure 1-2: Connectors

### 1.5 Dimensions

The main dimensions of the KINO-G410 are shown in the diagram below.

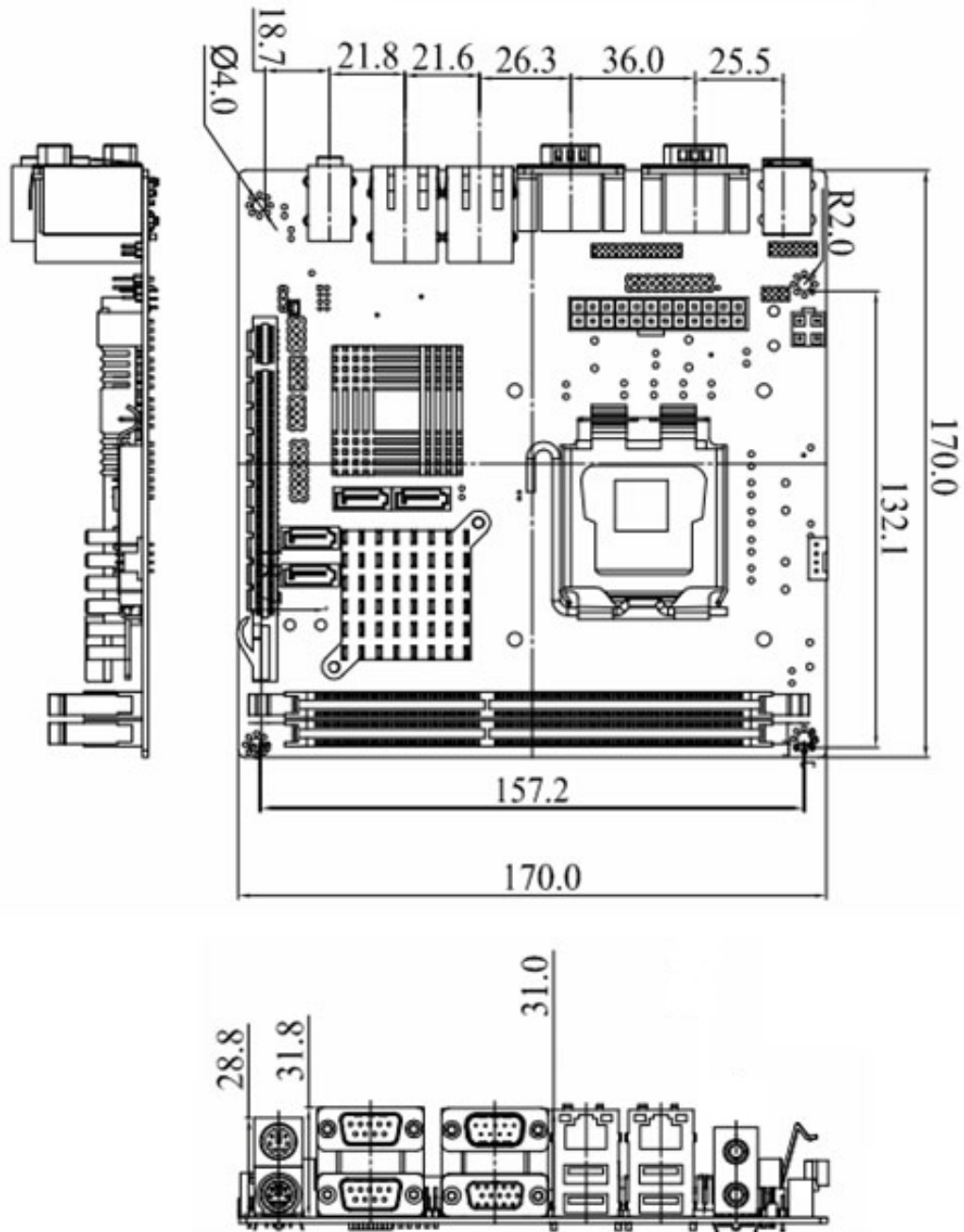


Figure 1-3: Dimensions (mm)



KINO-G410 Mini-ITX Motherboard

1.6 Data Flow

Figure 1-4 shows the data flow between the system chipset, the CPU and other components installed on the motherboard.

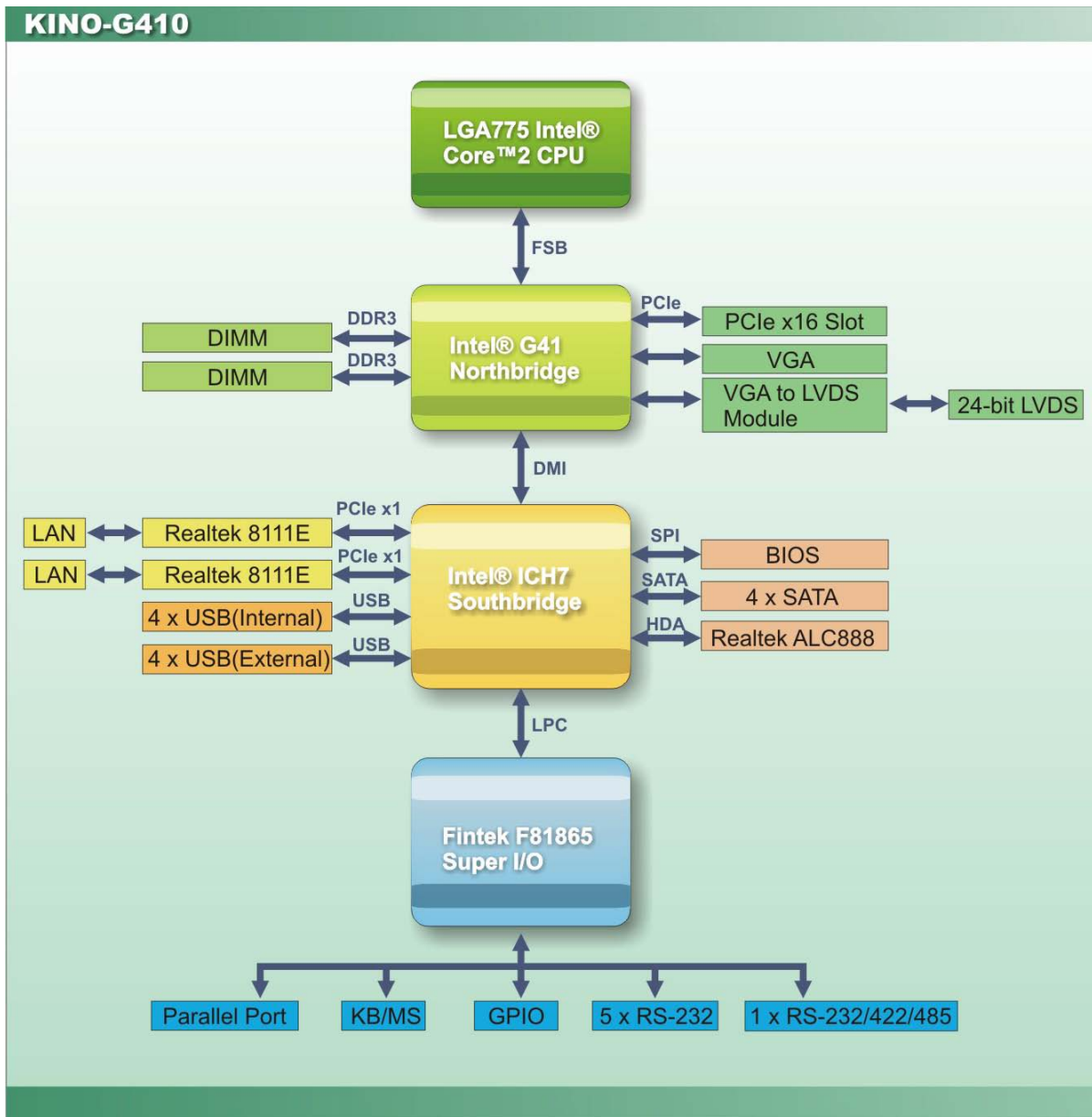


Figure 1-4: Data Flow Diagram

## 1.7 Technical Specifications

KINO-G410 technical specifications are shown below.

Specifications	KINO-G410
Form Factor	Mini-ITX
CPU Supported	Socket LGA775 Intel® Core™2 Duo/Quad/Extreme or Celeron® processor
Front Side Bus (FSB)	800/1066/1333 MHz
Northbridge Chipset	Intel® G41
Memory	Two 240-pin 800/1066 MHz dual-channel DDR3 SDRAM DIMMs (system max. 4 GB)
Graphic Engine	Intel® GMA4500
Integrated Graphics	VGA integrated in Intel® G41 24-bit LVDS via VGA to LVDS converter module
Southbridge Chipset	Intel® ICH7
BIOS	AMI BIOS
Digital I/O	8-bit, 4-bit input/4-bit output
Ethernet Controllers	Two Realtek RTL8111E PCIe GbE controllers with ASF2.0 support
Super I/O Controller	Fintek F81865
Watchdog Timer	Software programmable supports 1~255 sec. system reset
Audio	Realtek ALC888 HD Audio codec
Expansion	One PCIe x16 socket
<b>I/O Interface</b>	
Audio Jack	One line-out One mic-in
Fan connector	One 4-pin wafer for CPU fan One 3-pin wafer for system fan
Keyboard/Mouse	Two external PS/2 connectors

## KINO-G410 Mini-ITX Motherboard

Serial Ports	Five RS-232 COM connectors One RS-232/422/485 COM connector
USB 2.0/1.1 ports	Four internal via pin header Four external USB ports
Parallel Port	One parallel port via 26-pin header
Serial ATA	Four independent SATA channels with 3.0 Gb/s data transfer rates
Environmental and Power Specifications	
Power Supply	ATX supported
Power Consumption	5 V @ 6.41 A Vcore_12 V @ 2.52 A 3.3 V @ 0.27 A (2.8 GHz Intel® Core™2 Duo E7400 with two 1 GB 1066 MHz DDR3 DIMMs)
Operating temperature	-10°C ~ 60°C, requires cooler and silicone heat sink paste
Humidity	5% ~ 95% (non-condensing)
Physical Specifications	
Dimensions	170 mm x 170 mm
Weight (Gross/Net)	1100 g / 700 g

**Table 1-1: Technical Specifications**

Chapter

2

# Packing List

---

## KINO-G410 Mini-ITX Motherboard

### 2.1 Anti-static Precautions

---



#### WARNING!

Static electricity can destroy certain electronics. Make sure to follow the ESD precautions to prevent damage to the product, and injury to the user.

---

Make sure to adhere to the following guidelines:

- **Wear an anti-static wristband:** Wearing an anti-static wristband can prevent electrostatic discharge.
- **Self-grounding:** Touch a grounded conductor every few minutes to discharge any excess static buildup.
- **Use an anti-static pad:** When configuring any circuit board, place it on an anti-static mat.
- **Only handle the edges of the PCB:** Don't touch the surface of the motherboard. Hold the motherboard by the edges when handling.

### 2.2 Unpacking Precautions

When the KINO-G410 is unpacked, please do the following:

- Follow the antistatic guidelines above.
- Make sure the packing box is facing upwards when opening.
- Make sure all the packing list items are present.






## 2.3 Packing List



### NOTE:

If any of the components listed in the checklist below are missing, do not proceed with the installation. Contact the IEI reseller or vendor the KINO-G410 was purchased from or contact an IEI sales representative directly by sending an email to [sales@iei.com.tw](mailto:sales@iei.com.tw).

The KINO-G410 is shipped with the following components:







Quantity	Item and Part Number	Image
1	KINO-G410 SBC	
2	SATA cable (P/N: 32000-062800-RS)	
1	Mini jumper pack (2.0mm) (P/N:33100-000033-RS)	
1	Utility CD	
1	Quick Installation Guide	



**Table 2-1: Packing List**

## KINO-G410 Mini-ITX Motherboard

### 2.4 Optional Items

The following are optional components which may be separately purchased:

Item and Part Number	Image
CPU cooler kit <b>(P/N: CF-520-RS-R11)</b>	
CPU cooler kit <b>(P/N: CF-775A-RS)</b>	
USB cable <b>(P/N: CB-USB02-RS)</b>	
LPT cable (w/o bracket) <b>(P/N: 32200-015100-RS)</b>	
RS-232/422/485 cable <b>(P/N: 32205-000300-100-RS)</b>	
Dual RS-232 cable <b>(P/N: 19800-000051-RS)</b>	

Item and Part Number	Image
SATA power cable (P/N: 32100-088600-RS 32102-000100-100-RS 32102-000100-200-RS)	
VGA to LVDS (24-bit) converter module (P/N: VGA-LVDS-R10)	

**Table 2-2: Optional Items**



Chapter

3

# Connectors

---

### 3.1 Peripheral Interface Connectors

This chapter details all the jumpers and connectors.

#### 3.1.1 Layout

The figure below shows all the connectors and jumpers.

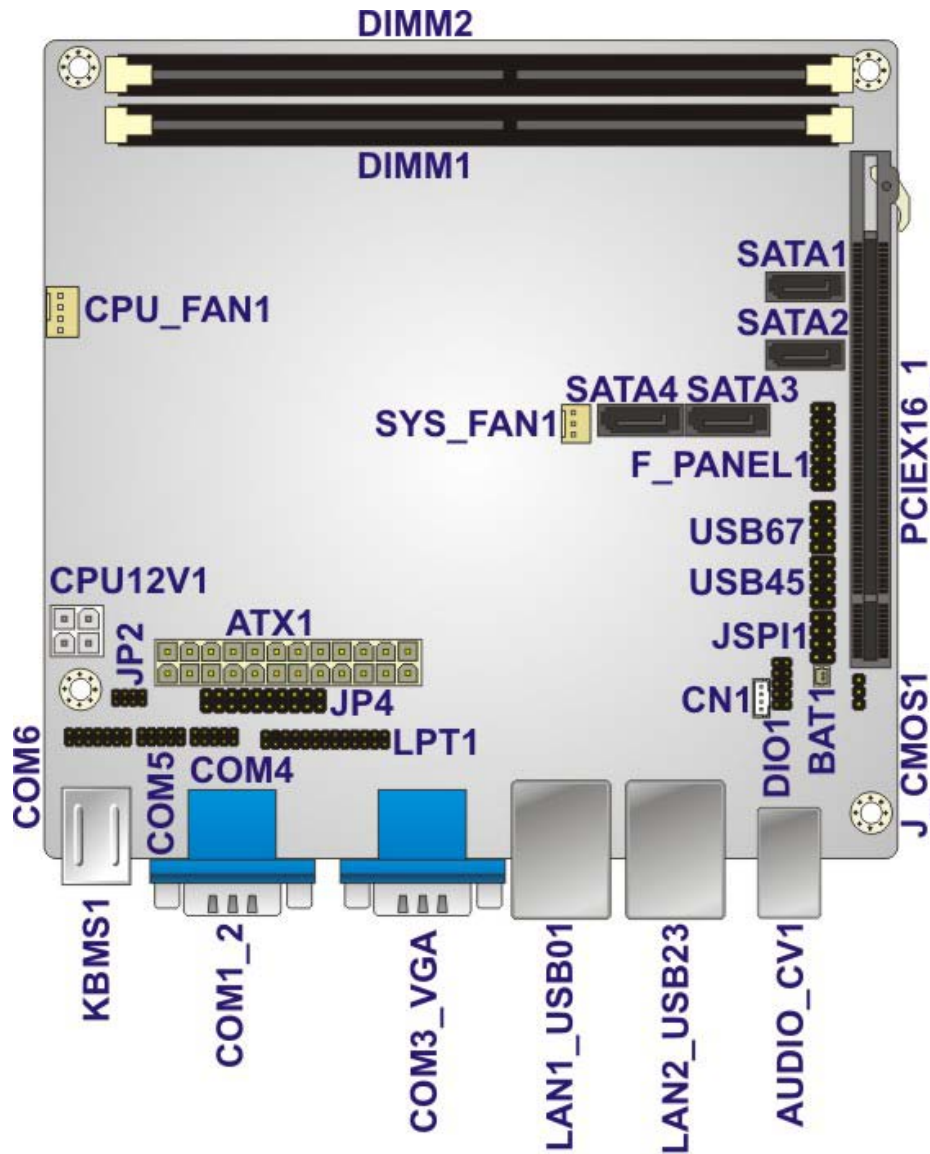


Figure 3-1: Connectors and Jumpers

### 3.1.2 Peripheral Interface Connectors

The table below lists all the connectors on the board.

Connector	Type	Label
Battery connector	2-pin wafer	BAT1
Fan connector (CPU)	4-pin wafer	CPU_FAN1
Fan connector (system)	3-pin wafer	SYS_FAN1
CPU Power Input Connector	4-pin connector	CPU12V1
Digital I/O connector	10-pin header	DIO1
Front panel connector	14-pin header	F_PANEL1
Memory slot	204-pin DDR3 DIMM slot	DIMM1, DIMM2
Parallel port connector	26-pin header	LPT1
PCIe x16 slot	PCIe x16 slot	PCIEX16_1
Power connector	24-pin connector	ATX1
RS-232 serial port connector	10-pin header	COM4, COM5
RS-232/422/485 serial port connector	14-pin header	COM6
SATA drive connectors	7-pin SATA drive connectors	SATA1, SATA2, SATA3, SATA4
SMBus connector	4-pin wafer	CN1
SPI Flash connector	8-pin header	JSPI1
USB connectors	8-pin header	USB45, USB67
VGA to LVDS connector	20-pin header	JP4

**Table 3–1: Internal Peripheral Connectors**

### 3.1.3 External Interface Panel Connectors

The table below lists the connectors on the external I/O panel.

Connector	Type	Label
Audio connector	Audio jack	AUDIO_CV1
Keyboard/Mouse connector	PS/2	KBMS1
LAN connector	RJ-45	LAN1, LAN2
Serial port connector	DB-9	COM1, COM2, COM3
USB connector	USB port	USB01, USB23
VGA connector	15-pin Female	VGA1

**Table 3-2: External Peripheral Connectors**

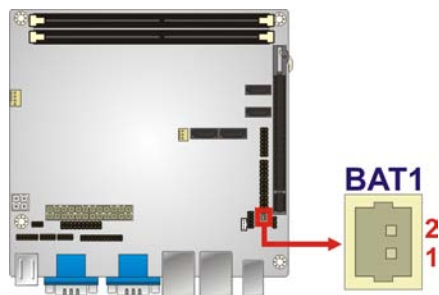
## 3.2 Internal Peripheral Connectors

The section describes all of the connectors on the KINO-G410.

### 3.2.1 Battery Connector

- CN Label:       BAT1
- CN Type:        2-pin wafer
- CN Location:    See **Figure 3-2**
- CN Pinouts:     See **Table 3-3**

This is connected to the system battery. The battery provides power to the system clock to retain the time when power is turned off.



**Figure 3-2: Battery Connector Location**

## KINO-G410 Mini-ITX Motherboard

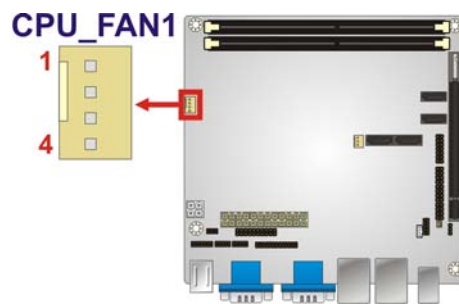
Pin	Description
1	Battery+ (+3V)
2	Ground

**Table 3-3: Battery Connector Pinouts**

### 3.2.2 CPU Fan Connector

CN Label:	CPU_FAN1
CN Type:	4-pin wafer
CN Location:	See <b>Figure 3-3</b>
CN Pinouts:	See <b>Table 3-4</b>

The fan connector attaches to a CPU cooling fan.



**Figure 3-3: CPU Fan Connector Location**

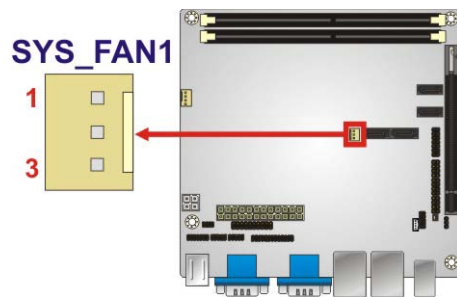
Pin	Description
1	GND
2	+12 V
3	Fan In
4	Fan Control

**Table 3-4: CPU Fan Connector Pinouts**

### 3.2.3 System Fan Connector

- CN Label:       SYS\_FAN1
- CN Type:        3-pin wafer
- CN Location:    See **Figure 3-4**
- CN Pinouts:     See **Table 3-5**

The fan connector attaches to a system cooling fan.



**Figure 3-4: CPU Fan Connector Location**

Pin	Description
1	Fan In
2	VCC_FAN
3	GND

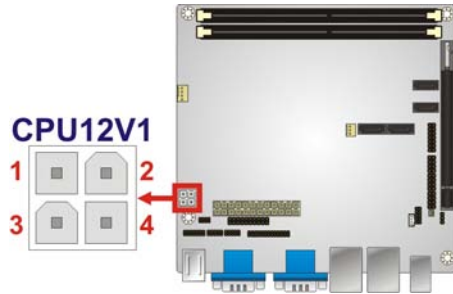
**Table 3-5: CPU Fan Connector Pinouts**

### 3.2.4 CPU Power Input Connector

- CN Label:       CPU12V1
- CN Type:        4-pin connector
- CN Location:    See **Figure 3-5**
- CN Pinouts:     See **Table 3-6**

The CPU power input connector provides power to the CPU.

## KINO-G410 Mini-ITX Motherboard



**Figure 3-5: CPU Power Input Connector Location**

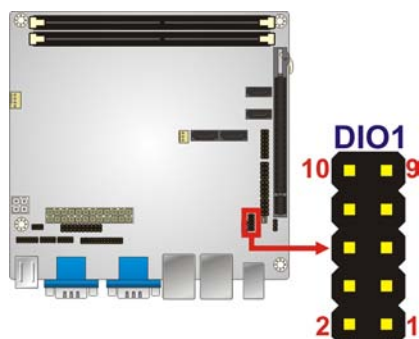
Pin	Description
1	GND
2	GND
3	+12 V
4	+12 V

**Table 3-6: CPU Power Input Connector Pinouts**

### 3.2.5 Digital I/O Connector

CN Label:	DIO1
CN Type:	10-pin header
CN Location:	See <b>Figure 3-6</b>
CN Pinouts:	See <b>Table 3-7</b>

The digital I/O connector provides programmable input and output for external devices. The digital I/O provides 4-bit output and 4-bit input.



**Figure 3-6: Digital I/O Connector Locations**

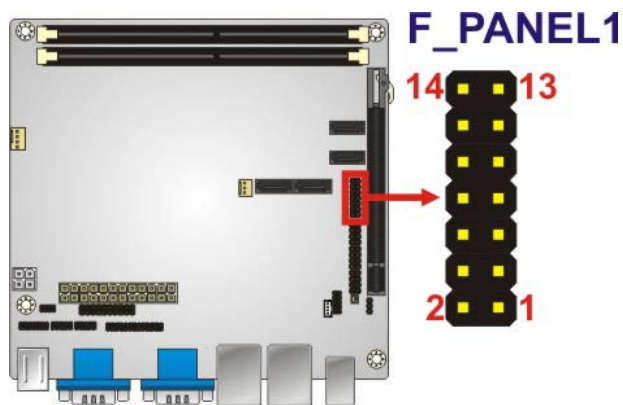
Pin	Description	Pin	Description
1	GND	2	VCC5S
3	Output 3	4	Output 2
5	Output 1	6	Output 0
7	Input 3	8	Input 2
9	Input 1	10	Input 0

**Table 3-7: Digital I/O Connector Pinouts**

### 3.2.6 Front Panel Connector

CN Label:	F_PANEL1
CN Type:	14-pin header
CN Location:	See <b>Figure 3-7</b>
CN Pinouts:	See <b>Table 3-8</b>

The front panel connector connects to the indicator LEDs and buttons on the computer's front panel.



**Figure 3-7: Front Panel Connector Location**



## KINO-G410 Mini-ITX Motherboard

FUNCTION	PIN	DESCRIPTION	FUNCTION	PIN	DESCRIPTION
Power LED	1	LED+	Buzzer	2	BEEP_PWR
	3	NC		4	NC
	5	LED-		6	NC
Power Button	7	BUTTON1		8	PC_BEEP
Button	9	BUTTON2	--	10	NC
HDD LED	11	HDD LED+	Reset	12	RESET
	13	HDD LED-		14	GND

**Table 3-8: Front Panel Connector Pinouts**

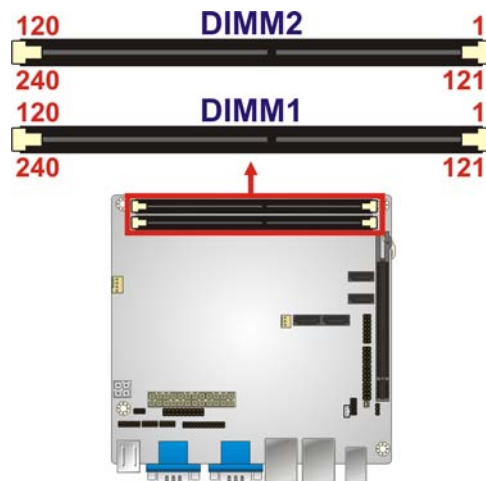
### 3.2.7 Memory Slot

CN Label: DIMM1, DIMM2

CN Type: DIMM slot

CN Location: See **Figure 3-8**

The DIMM slots are for DIMM memory modules.



**Figure 3-8: Memory Card Slot Location**

### 3.2.8 Parallel Port Connector

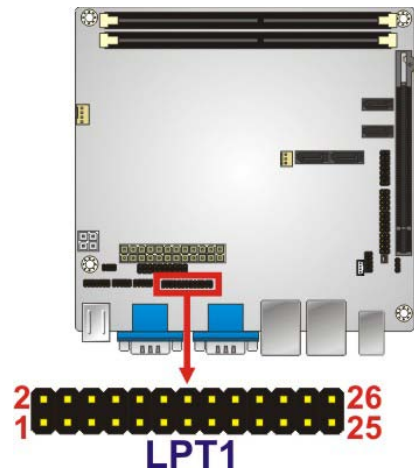
CN Label: LPT1

CN Type: 26-pin header

CN Location: See **Figure 3-9**

CN Pinouts: See **Table 3-9**

The parallel port connector connects to a parallel port connector interface or some other parallel port device such as a printer.



**Figure 3-9: Parallel Port Connector Location**

Pin	Description	Pin	Description
1	-STB	2	-AFD
3	PTD0	4	-ERR
5	PTD1	6	-INITR
7	PTD2	8	-SLIN
9	PTD3	10	GND
11	PTD4	12	GND
13	PTD5	14	GND
15	PTD6	16	GND
17	PTD7	18	GND
19	-ACK	20	GND
21	BUSY	22	GND
23	PE	24	GND
25	SLCT	26	NC

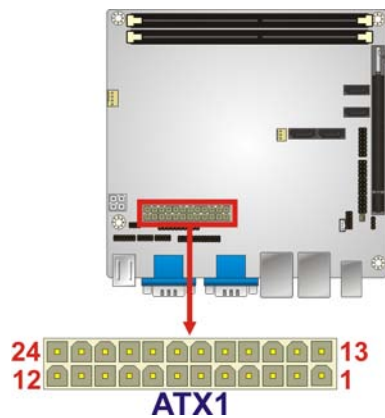
**Table 3-9: Parallel Port Connector Pinouts**

## KINO-G410 Mini-ITX Motherboard

### 3.2.9 Power Connector

- CN Label: ATX1
- CN Type: 24-pin connector
- CN Location: See **Figure 3-10**
- CN Pinouts: See **Table 3-10**

The power connector connects to an ATX power supply.



**Figure 3-10: Power Connector Location**

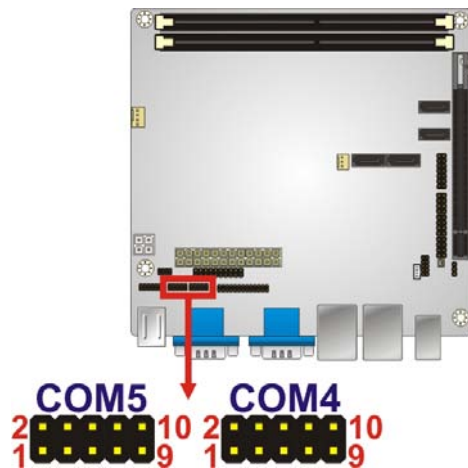
Pin	Description	Pin	Description
1	3.3V	13	3.3V
2	3.3V	14	-12V
3	GND	15	GND
4	5V	16	PS_ON-
5	GND	17	GND
6	5V	18	GND
7	GND	19	GND
8	ATXPWROK	20	NC
9	5VSB	21	5V
10	12V	22	5V
11	12V	23	5V
12	3.3V	24	GND

**Table 3-10: Power Connector Pinouts**

### 3.2.10 RS-232 Serial Port Connector

- CN Label: COM4, COM5
- CN Type: 10-pin header
- CN Location: See **Figure 3-11**
- CN Pinouts: See **Table 3-11**

This connector provides RS-232 communications.



**Figure 3-11: Serial Port Connector Location**

Pin	Description
1	Data Carrier Direct (DCD)
2	Receive Data (RXD)
3	Transmit Data (TXD)
4	Data Terminal Ready (DTR)
5	Ground (GND)
6	Data Set Ready (DSR)
7	Request To Send (RTS)
8	Clear To Send (CTS)
9	Ring Indicator (RI)
10	GND

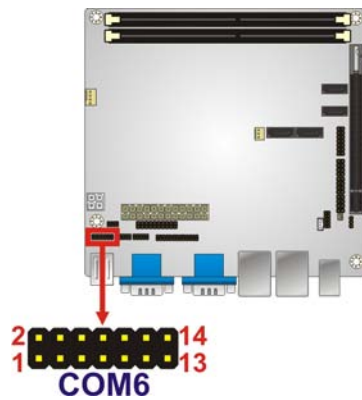
**Table 3-11: Serial Port Connector Pinouts**

## KINO-G410 Mini-ITX Motherboard

### 3.2.11 RS-232/422/485 Serial Port Connector

CN Label:	COM6
CN Type:	14-pin header
CN Location:	See <b>Figure 3-12</b>
CN Pinouts:	See <b>Table 3-12</b>

This connector provides RS-232, RS-422 or RS-485 communications.



**Figure 3-12: RS-232/422/485 Serial Port Connector Location**

Pin	Description	Pin	Description
1	DCD	2	DSR
3	RXD	4	RTS
5	TXD	6	CTS
7	DTR	8	RI
9	GND	10	GND
11	RS422 TX2/485	12	RS422 TX2-/485
13	RS422 RX2	14	RS422 RX2-

**Table 3-12: RS-232/422/485 Serial Port Connector Pinouts**

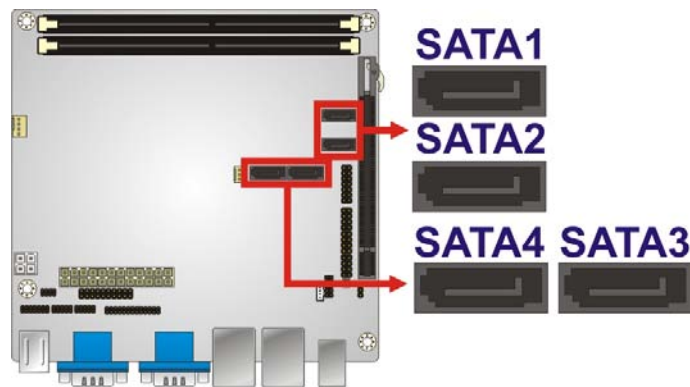
### 3.2.12 SATA Drive Connectors

CN Label: SATA1, SATA2, SATA3, SATA4

CN Type: 7-pin SATA drive connectors

CN Location: See **Figure 3-13**

The SATA drive connectors can be connected to SATA 3Gb/s drives.



**Figure 3-13: SATA Drive Connector Location**

### 3.2.13 SMBus Connector

CN Label: CN1

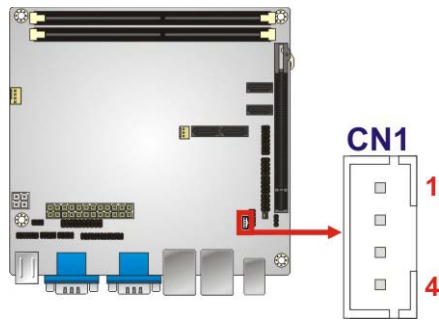
CN Type: 4-pin wafer

CN Location: See **Figure 3-14**

CN Pinouts: See **Table 3-13**

The SMBus (System Management Bus) connector provides low-speed system management communications.

## KINO-G410 Mini-ITX Motherboard



**Figure 3-14: SMBus Connector Location**

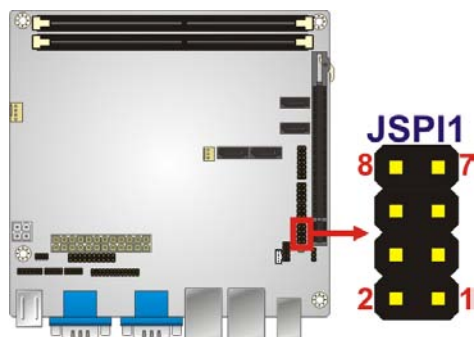
Pin	Description
1	GND
2	SDAT
3	SCLK
4	+5V

**Table 3-13: SMBus Connector Pinouts**

### 3.2.14 SPI Flash Connector

- CN Label: JSP11
- CN Type: 8-pin header
- CN Location: See **Figure 3-15**
- CN Pinouts: See **Table 3-14**

The 8-pin SPI Flash connector is used to flash the BIOS.



**Figure 3-15: SPI Flash Connector**

Pin	Description	Pin	Description
1	+3.3V	2	GND
3	CS#	4	CLOCK
5	SO	6	SI
7	NC	8	NC

**Table 3-14: SPI Flash Connector**

### 3.2.15 USB Connectors

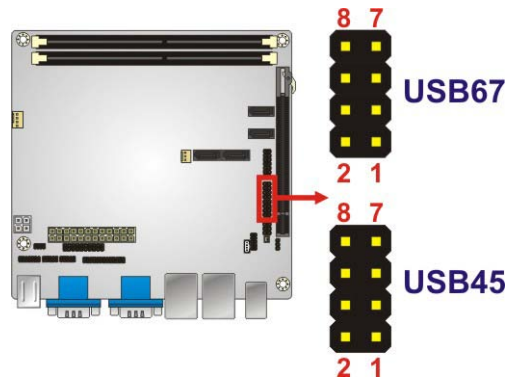
CN Label: USB45, USB67

CN Type: 8-pin header

CN Location: See **Figure 3-16**

CN Pinouts: See **Table 3-15**

The USB connectors connect to USB devices. Each pin header provides two USB ports.


**Figure 3-16: USB Connector Pinout Locations**

Pin	Description	Pin	Description
1	+5V	2	GND
3	DATA1-	4	DATA2+
5	DATA1+	6	DATA2-
7	GND	8	+5V

**Table 3-15: USB Port Connector Pinouts**

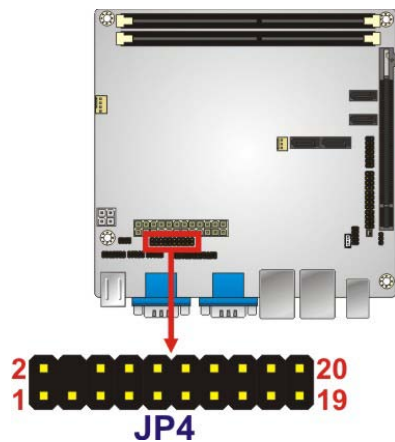


## KINO-G410 Mini-ITX Motherboard

### 3.2.16 VGA to LVDS Connector

CN Label:	JP4
CN Type:	20-pin header
CN Location:	See <b>Figure 3-17</b>
CN Pinouts:	See <b>Table 3-16</b>

This connector connects to the optional VGA to LVDS converter module and provides the 24-bit LVDS interface.



**Figure 3-17: VGA to LVDS Connector Location**

Pin	Description	Pin	Description
1	GND	2	+5V
3	H-SYNCBUF-OUT_R	4	NC
5	V-SYNCBUF-OUT_R	6	+5V
7	GND	8	GND
9	CH1BUF-OUT_RED	10	+3.3V
11	CH1BUF-OUT_GREEN	12	+3.3V
13	CH1BUF-OUT_BLUE	14	+3.3V
15	GND	16	GND
17	5VDDCDA	18	+12V
19	5VDDCLK	20	+12V

**Table 3-16: VGA to LVDS Connector Pinouts**

### 3.3 External Peripheral Interface Connector Panel

The figure below shows the external peripheral interface connector (EPIC) panel. The EPIC panel consists of the following:

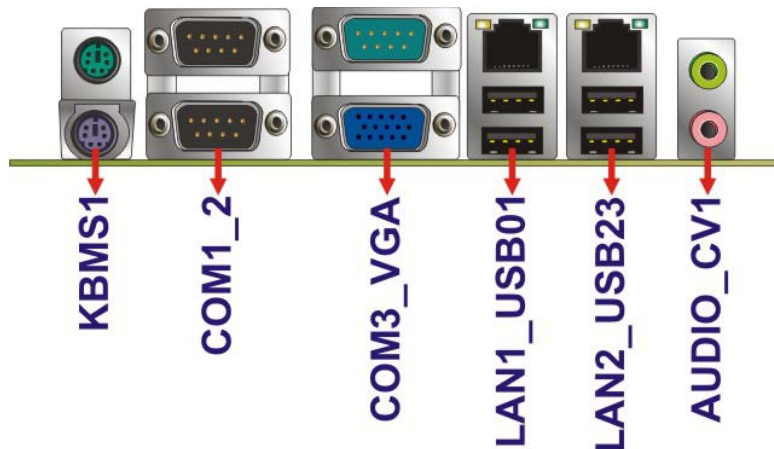


Figure 3-18: External Peripheral Interface Connector

#### 3.3.1 Audio Connector

CN Label: AUDIO\_CV1  
 CN Type: Audio jacks  
 CN Location: See **Figure 3-18**

The audio jacks connect to external audio devices.

- **Line Out port (Lime):** Connects to a headphone or a speaker. With multi-channel configurations, this port can also connect to front speakers.
- **Microphone (Pink):** Connects a microphone.



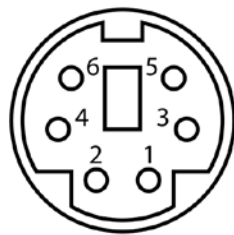
Figure 3-19: Audio Connector

## KINO-G410 Mini-ITX Motherboard

### 3.3.2 Keyboard/Mouse Connector

- CN Label: KBMS1
- CN Type: PS/2
- CN Location: See **Figure 3-18**
- CN Pinouts: See **Table 3-17, Figure 3-20**

The keyboard and mouse connector is a standard PS/2 connector.



**Figure 3-20: PS/2 Pinout and Configuration**

Pin	Description
1	KB DATA
2	MS DATA
3	GND
4	VCC (+5V)
5	KB CLOCK
6	MS CLOCK

**Table 3-17: Keyboard Connector Pinouts**

### 3.3.3 LAN Connector

- CN Label: LAN1, LAN2
- CN Type: RJ-45
- CN Location: See **Figure 3-18**
- CN Pinouts: See **Table 3-18**

The LAN connector connects to a local network.

Pin	Description	Pin	Description
1	MDIA3-	5	MDIA1+
2	MDIA3+	6	MDIA2+-
3	MDIA2-	7	MDIA0-
4	MDIA1-	8	MDIA0+

**Table 3-18: LAN Pinouts**

### 3.3.4 Serial Port Connectors (COM1, COM2 and COM3)

CN Label: COM1, COM2, COM3

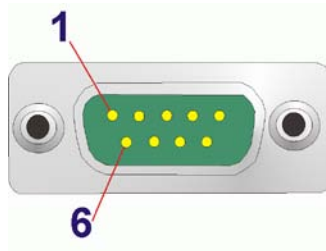
CN Type: DB-9 connectors

CN Location: See **Figure 3-18**

CN Pinouts: See **Table 3-19** and **Figure 3-21**

The serial port connects to a RS-232 serial communications device.

Pin	Description	Pin	Description
1	DCD	6	DSR
2	RX	7	RTS
3	TX	8	CTS
4	DTR	9	RI
5	GND		

**Table 3-19: Serial Port Pinouts**

**Figure 3-21: Serial Port Pinouts**

## KINO-G410 Mini-ITX Motherboard

### 3.3.5 USB Connector

- CN Label: USB01, USB23
- CN Type: USB port
- CN Location: See **Figure 3-18**
- CN Pinouts: See **Table 3-20**

The USB connector can be connected to a USB device.

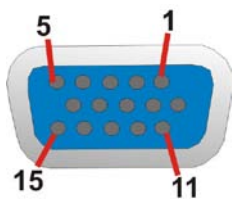
Pin	Description	Pin	Description
1	+5 V	2	+5 V
3	DATA-	4	DATA-
5	DATA+	6	DATA+
7	GND	8	GND

**Table 3-20: USB Port Pinouts**

### 3.3.6 VGA Connector

- CN Label: VGA1
- CN Type: 15-pin Female
- CN Location: See **Figure 3-18**
- CN Pinouts: See **Figure 3-22** and **Table 3-21**

The VGA connector connects to a monitor that accepts a standard VGA input.



**Figure 3-22: VGA Connector**

Pin	Description	Pin	Description
1	RED	2	GREEN
3	BLUE	4	NC
5	GND	6	GND
7	GND	8	GND
9	VCC / NC	10	GND
11	NC	12	DDC DAT
13	HSYNC	14	VSYNC
15	DDCCLK		

**Table 3-21: VGA Connector Pinouts**

Chapter

4

# Installation

---

## 4.1 Anti-static Precautions

---



### WARNING:

Failure to take ESD precautions during the installation of the KINO-G410 may result in permanent damage to the KINO-G410 and severe injury to the user.

---

Electrostatic discharge (ESD) can cause serious damage to electronic components, including the KINO-G410. Dry climates are especially susceptible to ESD. It is therefore critical that whenever the KINO-G410 or any other electrical component is handled, the following anti-static precautions are strictly adhered to.

- **Wear an anti-static wristband:** Wearing a simple anti-static wristband can help to prevent ESD from damaging the board.
- **Self-grounding:** Before handling the board, touch any grounded conducting material. During the time the board is handled, frequently touch any conducting materials that are connected to the ground.
- **Use an anti-static pad:** When configuring the KINO-G410, place it on an anti-static pad. This reduces the possibility of ESD damaging the KINO-G410.
- **Only handle the edges of the PCB:** When handling the PCB, hold the PCB by the edges.

## 4.2 Installation Considerations

---



### NOTE:

The following installation notices and installation considerations should be read and understood before installation. All installation notices must be strictly adhered to. Failing to adhere to these precautions may lead to severe damage and injury to the person performing the installation.

---



**WARNING:**

The installation instructions described in this manual should be carefully followed in order to prevent damage to the components and injury to the user.

Before and during the installation please **DO** the following:

- Read the user manual:
  - The user manual provides a complete description of the KINO-G410 installation instructions and configuration options.
- Wear an electrostatic discharge cuff (ESD):
  - Electronic components are easily damaged by ESD. Wearing an ESD cuff removes ESD from the body and helps prevent ESD damage.
- Place the KINO-G410 on an antistatic pad:
  - When installing or configuring the motherboard, place it on an antistatic pad. This helps to prevent potential ESD damage.
- Turn all power to the KINO-G410 off:
  - When working with the KINO-G410, make sure that it is disconnected from all power supplies and that no electricity is being fed into the system.

Before and during the installation of the KINO-G410 **DO NOT:**

- Remove any of the stickers on the PCB board. These stickers are required for warranty validation.
- Use the product before verifying all the cables and power connectors are properly connected.
- Allow screws to come in contact with the PCB circuit, connector pins, or its components.

## 4.3 Basic Installation

This section outlines the parts that must be installed for the system to function correctly.

### 4.3.1 CPU Installation



#### NOTE:

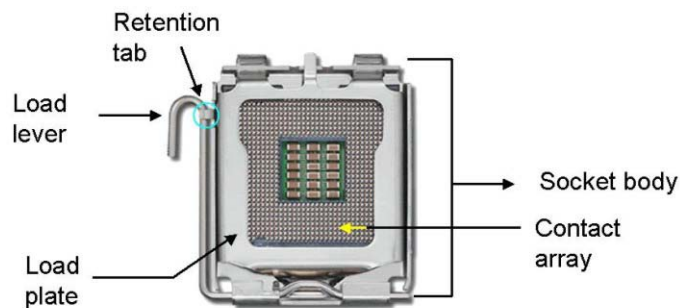
To enable Hyper-Threading, the CPU and chipset must both support it.



#### WARNING:

CPUs are expensive and sensitive components. When installing the CPU please be careful not to damage it in anyway. Make sure the CPU is installed properly and ensure the correct cooling kit is properly installed.

The LGA775 socket is shown in **Figure 4-1**.



**Figure 4-1: Intel LGA775 Socket**

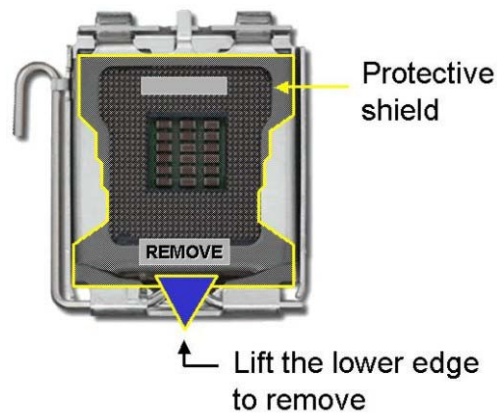
To install the CPU, follow the steps below.

## KINO-G410 Mini-ITX Motherboard

**WARNING:**

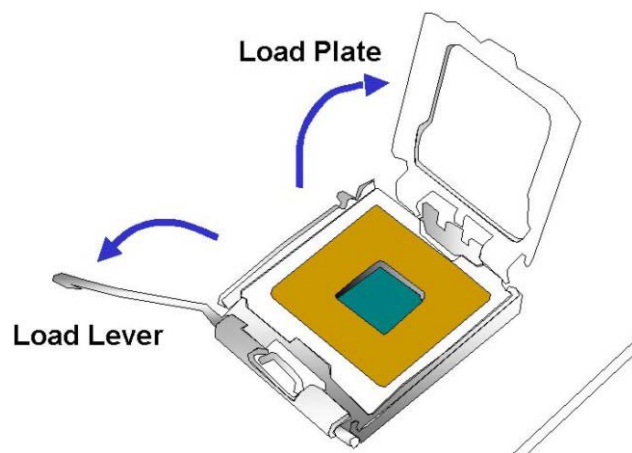
DO NOT touch the pins at the bottom of the CPU. When handling the CPU, only hold it on the sides.

**Step 1:** **Remove the protective cover.** The black protective cover can be removed by pulling up on the tab labeled "Remove". See **Figure 4-2**.



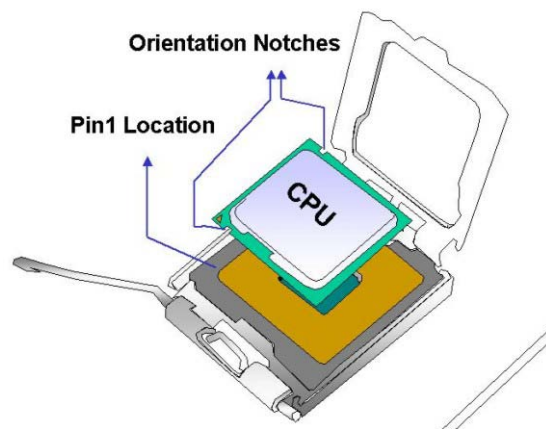
**Figure 4-2: Remove Protective Cover**

**Step 2:** **Open the socket.** Disengage the load lever by pressing the lever down and slightly outward to clear the retention tab. Fully open the lever, then open the load plate. See **Figure 4-3**.



**Figure 4-3: CPU Socket Load Plate**

- Step 3:** **Inspect the CPU socket.** Make sure there are no bent pins and make sure the socket contacts are free of foreign material. If any debris is found, remove it with compressed air.
- Step 4:** **Orientate the CPU properly.** The contact array should be facing the CPU socket.
- Step 5:** **Correctly position the CPU.** Match the Pin 1 mark with the cut edge on the CPU socket.
- Step 6:** **Align the CPU pins.** Locate pin 1 and the two orientation notches on the CPU. Carefully match the two orientation notches on the CPU with the socket alignment keys.
- Step 7:** **Insert the CPU.** Gently insert the CPU into the socket. If the CPU pins are properly aligned, the CPU should slide into the CPU socket smoothly. See **Figure 4-4.**



**Figure 4-4: Insert the Socket LGA775 CPU**

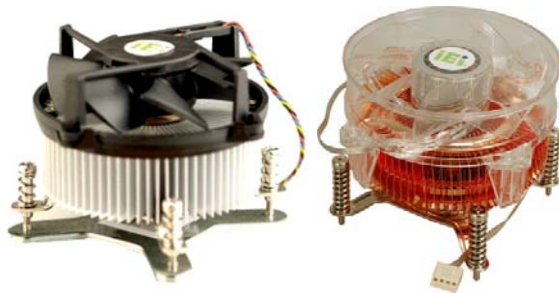
- Step 8:** **Close the CPU socket.** Close the load plate and engage the load lever by pushing it back to its original position. There will be some resistance, but will not require extreme pressure.
- Step 9:** **Connect the 12 V power to the board.** Connect the 12 V power from the power supply to the board.

### 4.3.2 Cooling Kit Installation

**WARNING:**

DO NOT use the original Intel® heat sink and fan. A proprietary one is recommended.

---



**Figure 4-5: Cooling Kits**

The cooling kit can be bought from IEI. The cooling kit has a heatsink and fan.

**WARNING:**

Do not wipe off (accidentally or otherwise) the pre-sprayed layer of thermal paste on the bottom of the heat sink. The thermal paste between the CPU and the heat sink is important for optimum heat dissipation.

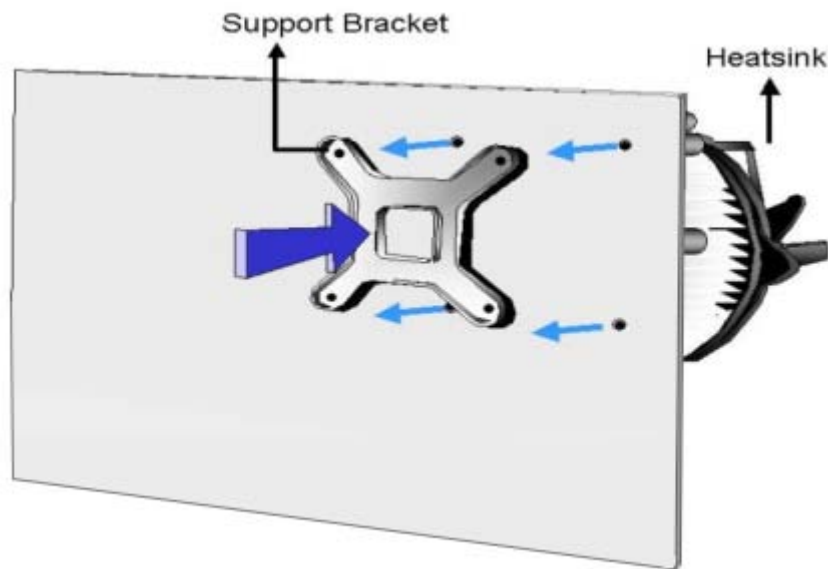
---

To install the cooling kit, follow the instructions below.

**Step 1:** Place the cooling kit onto the socket LGA775 CPU. Make sure the CPU cable can be properly routed when the cooling kit is installed.

**Step 2:** Properly align the cooling kit. Make sure the four spring screw fasteners can pass through the pre-drilled holes on the PCB.

- Step 3: Mount the cooling kit.** Gently place the cooling kit on top of the CPU. Make sure the four threaded screws on the corners of the cooling kit properly pass through the predrilled holes on the bottom of the PCB.
- Step 4: Secure the cooling kit.** From the solder side of the PCB, align the support bracket to the screw threads on heat sink that were inserted through the PCB holes. (See **Figure 4-6**)



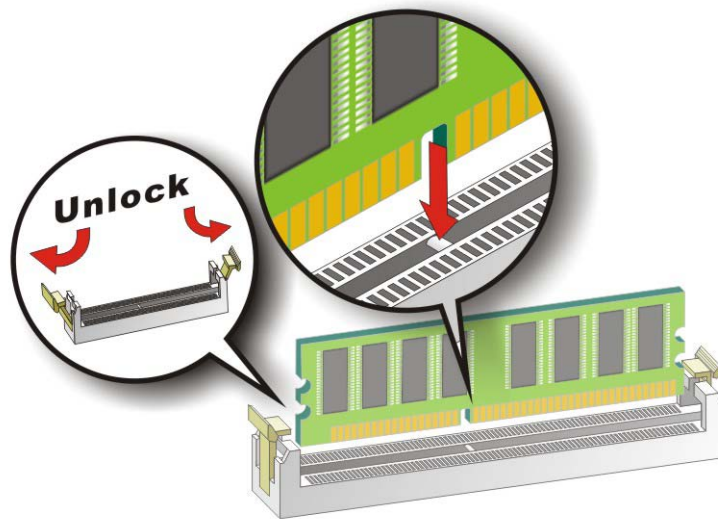
**Figure 4-6: Securing the Heat sink to the KINO-G410**

- Step 5: Tighten the screws.** Use a screwdriver to tighten the four screws. Tighten each nut a few turns at a time and do not over-tighten the screws.
- Step 6: Connect the fan cable.** Connect the cooling kit fan cable to the fan connector on the KINO-G410. Carefully route the cable and avoid heat generating chips and fan blades.

## KINO-G410 Mini-ITX Motherboard

### 4.3.3 DIMM Installation

To install a DIMM, please follow the steps below and refer to **Figure 4-7**.



**Figure 4-7: DIMM Installation**

- Step 1: Open the DIMM socket handles.** Open the two handles outwards as far as they can. See **Figure 4-7**.
- Step 2: Align the DIMM with the socket.** Align the DIMM so the notch on the memory lines up with the notch on the memory socket. See **Figure 4-7**.
- Step 3: Insert the DIMM.** Once aligned, press down until the DIMM is properly seated. Clip the two handles into place. See **Figure 4-7**.
- Step 4: Removing a DIMM.** To remove a DIMM, push both handles outward. The memory module is ejected by a mechanism in the socket.

### 4.3.4 Motherboard Installation

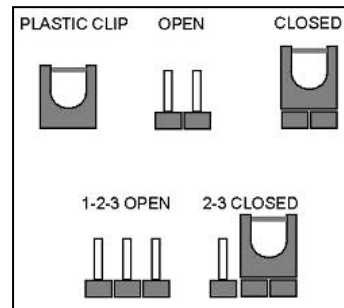
To install the KINO-G410 motherboard into the chassis please refer to the reference material that came with the chassis.

## 4.4 Jumper Settings



### NOTE:

A jumper is a metal bridge used to close an electrical circuit. It consists of two or three metal pins and a small metal clip (often protected by a plastic cover) that slides over the pins to connect them. To CLOSE/SHORT a jumper means connecting the pins of the jumper with the plastic clip and to OPEN a jumper means removing the plastic clip from a jumper.



The KINO-G410 includes one jumper shown in **Table 4-1**.

Description	Label	Type
Clear CMOS jumper	J_CMOS1	3-pin header
COM6 function select jumper	JP2	8-pin header

**Table 4-1: Jumpers**

### 4.4.1 Clear CMOS Jumper

Jumper Label:	J_CMOS1
Jumper Type:	3-pin header
Jumper Settings:	See <b>Table 4-2</b>
Jumper Location:	See <b>Figure 4-8</b>

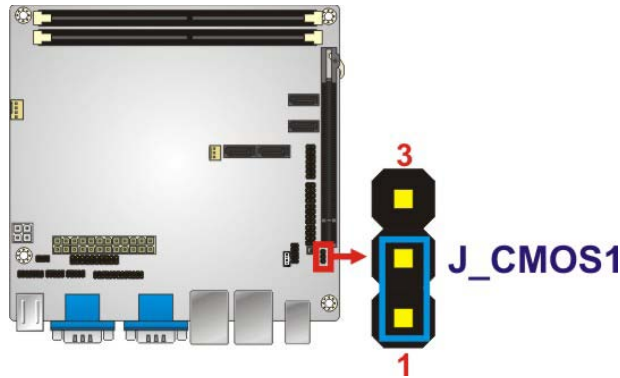
To reset the BIOS, move the jumper to the "Clear BIOS" position for 3 seconds or more, and then move back to the default position.



## KINO-G410 Mini-ITX Motherboard

Pin	Description
Short 1-2	Normal (Default)
Short 2-3	Clear BIOS

**Table 4-2: Clear BIOS Jumper Settings**



**Figure 4-8: Clear BIOS Jumper Location**

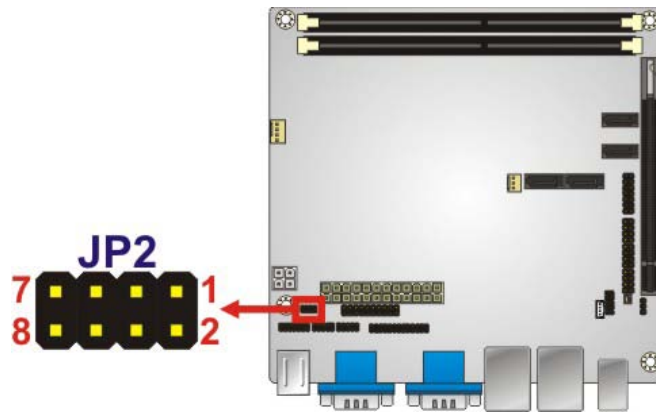
### 4.4.2 COM 6 Function Select Jumper

Jumper Label:	JP2
Jumper Type:	8-pin header
Jumper Settings:	See Table 4-3
Jumper Location:	See Figure 4-9

The COM 6 Function Select jumper sets the communication protocol used by the second serial communications port (COM 6) as RS-232, RS-422 or RS-485. The COM 6 Function Select settings are shown in **Table 4-3**.

Setting	Description
Short 1-2	RS-232 (Default)
Short 3-4	RS-422
Short 5-6	RS-485
Short 7-8	RS-485 with RTS control

**Table 4-3: COM 6 Function Select Jumper Settings**



**Figure 4-9: COM 6 Function Select Jumper Location**

## 4.5 Internal Peripheral Device Connections

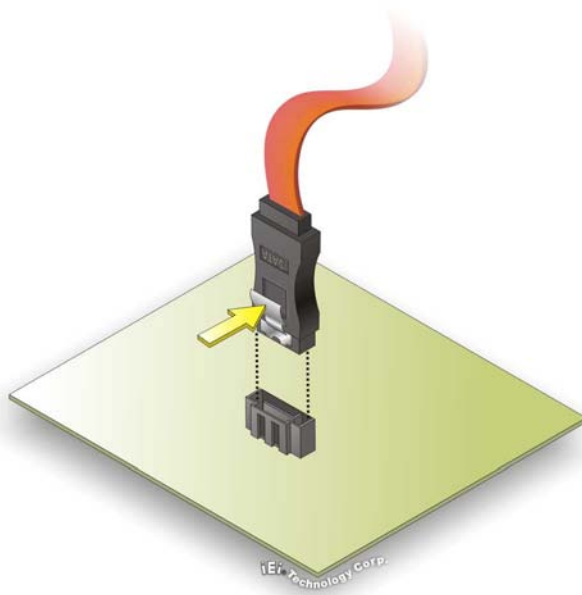
This section outlines the installation of peripheral devices to the onboard connectors.

### 4.5.1 SATA Drive Connection

The KINO-G410 is shipped with two SATA drive cables and one SATA drive power cable. To connect the SATA drives to the connectors, please follow the steps below.

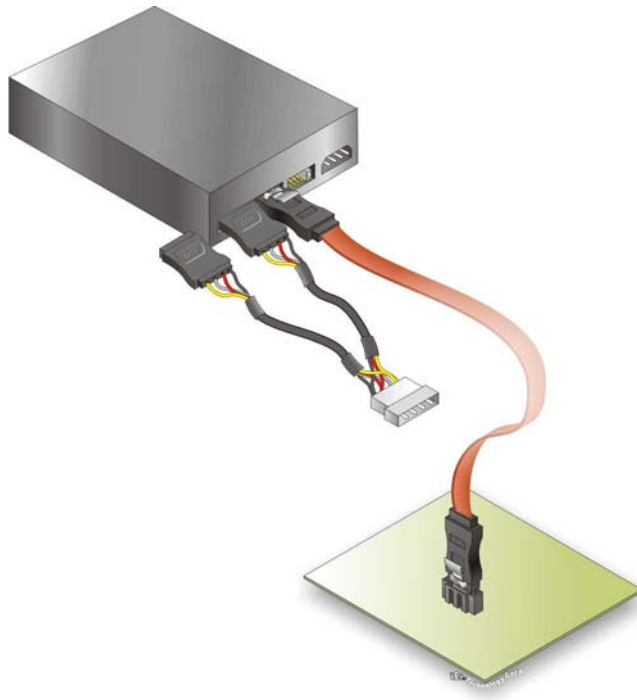
**Step 1: Locate the connectors.** The locations of the SATA drive connectors are shown in **Chapter 3**.

**Step 2: Insert the cable connector.** Press the clip on the connector at the end of the SATA cable and insert the cable connector into the on-board SATA drive connector. See **Figure 4-10**.



**Figure 4-10: SATA Drive Cable Connection**

- Step 3:** **Connect the cable to the SATA disk.** Connect the connector on the other end of the cable to the connector at the back of the SATA drive. See **Figure 4-11**.
- Step 4:** **Connect the SATA power cable.** Connect the SATA power connector to the back of the SATA drive. See **Figure 4-11**.



**Figure 4-11: SATA Power Drive Connection**

#### 4.5.2 USB Cable (Dual Port) with Slot Bracket

The KINO-G410 is shipped with a dual port USB 2.0 cable. To connect the USB cable connector, please follow the steps below.

**Step 1: Locate the connectors.** The locations of the USB connectors are shown in **Chapter 3**.



**WARNING:**

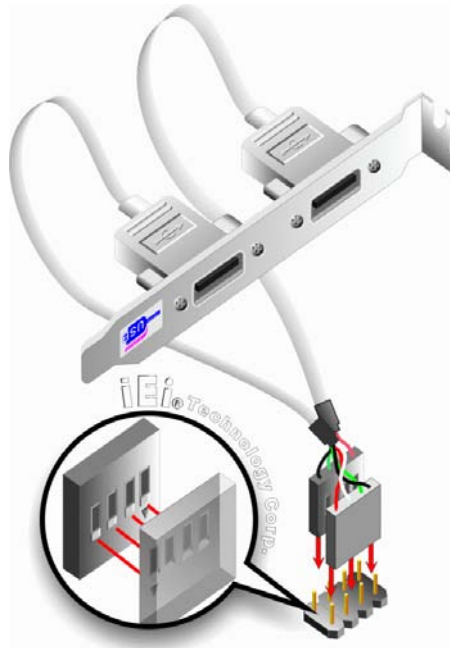
If the USB pins are not properly aligned, the USB device can burn out.

---

**Step 2: Align the connectors.** The cable has two connectors. Correctly align pin 1 on each cable connector with pin 1 on the KINO-G410 USB connector.

## KINO-G410 Mini-ITX Motherboard

**Step 3: Insert the cable connectors** Once the cable connectors are properly aligned with the USB connectors on the KINO-G410, connect the cable connectors to the on-board connectors. See **Figure 4-12**.



**Figure 4-12: Dual USB Cable Connection**

**Step 4: Attach the bracket to the chassis.** The USB 2.0 connectors are attached to a bracket. To secure the bracket to the chassis please refer to the installation instructions that came with the chassis.

## 4.6 External Peripheral Interface Connection

This section describes connecting devices to the external connectors on the KINO-G410.

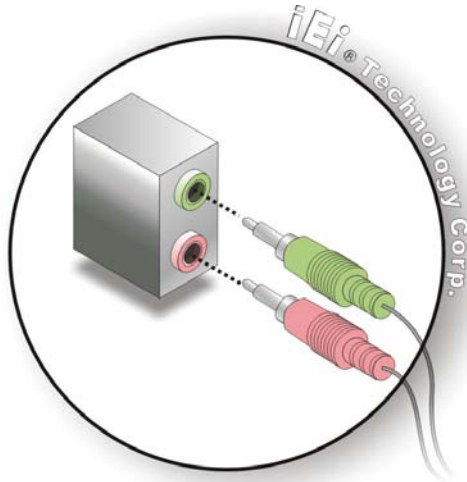
### 4.6.1 Audio Connector

The audio jacks on the external audio connector enable the KINO-G410 to be connected to a stereo sound setup. To install the audio devices, follow the steps below.

**Step 1: Identify the audio plugs.** The plugs on your home theater system or speakers may not match the colors on the rear panel. If audio plugs are plugged into the wrong jacks, sound quality will be very bad.

**Step 2:** **Plug the audio plugs into the audio jacks.** Plug the audio plugs into the audio jacks. If the plugs on your speakers are different, an adapter will need to be used to plug them into the audio jacks.

- **Line Out port (Lime):** Connects to a headphone or a speaker.
- **Microphone (Pink):** Connects to a microphone.



**Figure 4-13: Audio Connector**

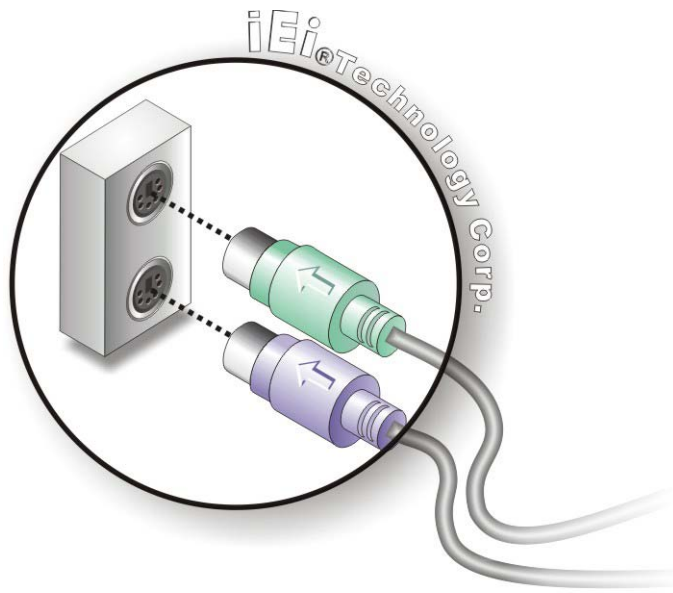
**Step 3:** **Check audio clarity.** Check that the sound is coming through the right speakers by adjusting the balance front to rear and left to right.

#### 4.6.2 PS/2 Keyboard and Mouse Connection

The KINO-G410 has a dual PS/2 connector on the external peripheral interface panel. The dual PS/2 connector is used to connect to a keyboard and mouse to the system. Follow the steps below to connect a keyboard and mouse to the KINO-G410.

**Step 1:** **Locate the dual PS/2 connector.** The location of the dual PS/2 connector is shown in **Chapter 3**.

**Step 2:** **Insert the keyboard/mouse connector.** Insert a PS/2 keyboard or mouse connector into the appropriate PS/2 connector on the external peripheral interface connector. See Figure 4-14.



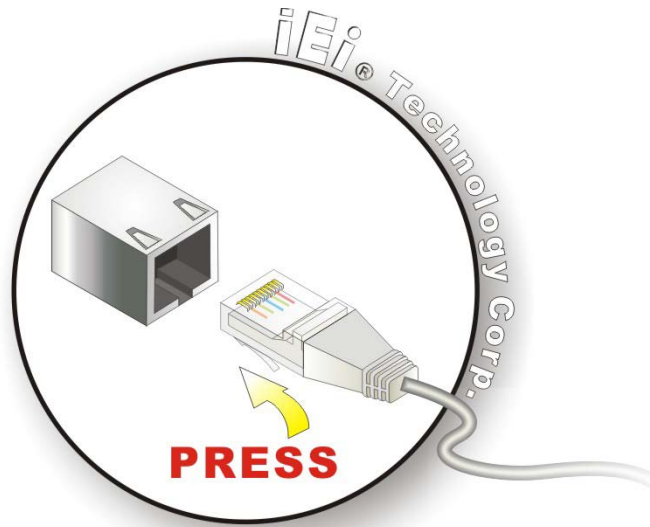
**Figure 4-14: PS/2 Keyboard/Mouse Connector**

#### 4.6.3 LAN Connection

There are two external RJ-45 LAN connectors. The RJ-45 connectors enable connection to an external network. To connect a LAN cable with an RJ-45 connector, please follow the instructions below.

**Step 1: Locate the RJ-45 connectors.** The locations of the USB connectors are shown in **Chapter 4**.

**Step 2: Align the connectors.** Align the RJ-45 connector on the LAN cable with one of the RJ-45 connectors on the KINO-G410. See **Figure 4-15**.



**Figure 4-15: LAN Connection**

**Step 3:** Insert the LAN cable RJ-45 connector. Once aligned, gently insert the LAN cable RJ-45 connector into the on-board RJ-45 connector.

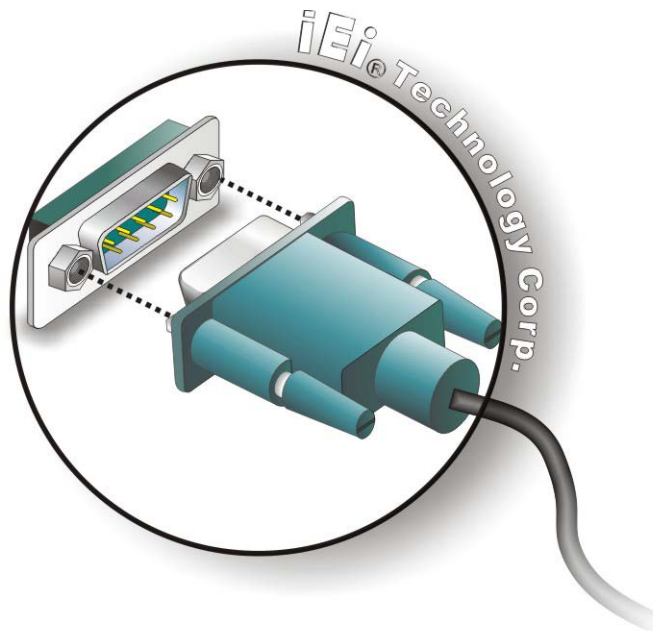
#### 4.6.4 Serial Device Connection

The KINO-G410 has three male DB-9 connectors on the external peripheral interface panel for a serial device. Follow the steps below to connect a serial device to the KINO-G410.

**Step 1:** Locate the DB-9 connector. The location of the DB-9 connector is shown in Chapter 3.

**Step 2:** Insert the serial connector. Insert the DB-9 connector of a serial device into the DB-9 connector on the external peripheral interface. See Figure 4-16.





**Figure 4-16: Serial Device Connector**

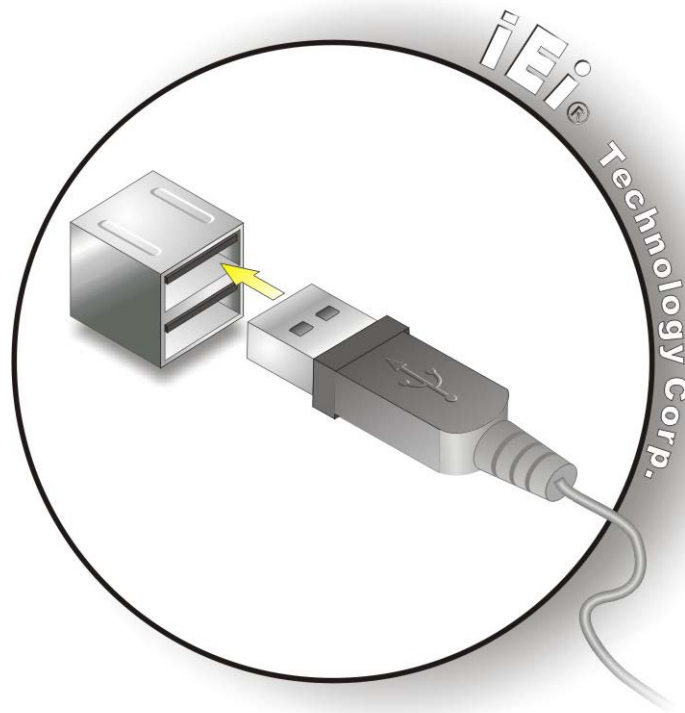
**Step 3: Secure the connector.** Secure the serial device connector to the external interface by tightening the two retention screws on either side of the connector.

#### 4.6.5 USB Device Connection

The external USB Series "A" receptacle connectors provide easier and quicker access to external USB devices. Follow the steps below to connect USB devices to the KINO-G410.

**Step 1: Locate the USB Series "A" receptacle connectors.** The location of the USB Series "A" receptacle connectors are shown in **Chapter 3**.

**Step 2: Insert a USB Series "A" plug.** Insert the USB Series "A" plug of a device into the USB Series "A" receptacle on the external peripheral interface. See **Figure 4-17**.

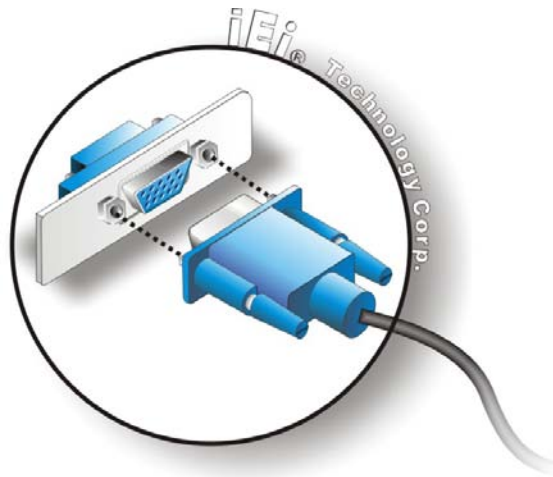


**Figure 4-17: USB Connector**

#### 4.6.6 VGA Monitor Connection

The KINO-G410 has a single female DB-15 connector on the external peripheral interface panel. The DB-15 connector is connected to a CRT or VGA monitor. To connect a monitor to the KINO-G410, please follow the instructions below.

- Step 1: Locate the female DB-15 connector.** The location of the female DB-15 connector is shown in **Chapter 3**.
- Step 2: Align the VGA connector.** Align the male DB-15 connector on the VGA screen cable with the female DB-15 connector on the external peripheral interface.
- Step 3: Insert the VGA connector** Once the connectors are properly aligned with the insert the male connector from the VGA screen into the female connector on the KINO-G410. See **Figure 4-18**.



**Figure 4-18: VGA Connector**

**Step 4:** **Secure the connector.** Secure the DB-15 VGA connector from the VGA monitor to the external interface by tightening the two retention screws on either side of the connector.

## 4.7 Software Installation

All the drivers for the KINO-G410 are on the CD that came with the system. To install the drivers, please follow the steps below.

**Step 1:** Insert the CD into a CD drive connected to the system.



### NOTE:

If the installation program doesn't start automatically:  
Click "Start->My Computer->CD Drive->autorun.exe"

**Step 2:** The driver main menu appears.

**Step 3:** Click KINO-G410.

**Step 4:** A new screen with a list of available drivers appears.

**Step 5:** Install all of the necessary drivers in this menu.

Chapter

5

**BIOS**

---

## 5.1 Introduction

The BIOS is programmed onto the BIOS chip. The BIOS setup program allows changes to certain system settings. This chapter outlines the options that can be changed.

### 5.1.1 Starting Setup

The AMI BIOS is activated when the computer is turned on. The setup program can be activated in one of two ways.

1. Press the **DELETE** key as soon as the system is turned on or
2. Press the **DELETE** key when the “**Press DEL to enter SETUP**” message appears on the screen.

If the message disappears before the **DELETE** key is pressed, restart the computer and try again.

### 5.1.2 Using Setup

Use the arrow keys to highlight items, press **ENTER** to select, use the PageUp and PageDown keys to change entries, press **F1** for help and press **ESC** to quit. Navigation keys are shown in **Table 5-1**.

Key	Function
Up arrow	Move to previous item
Down arrow	Move to next item
Left arrow	Move to the item on the left hand side
Right arrow	Move to the item on the right hand side
Esc key	Main Menu – Quit and not save changes into CMOS Status Page Setup Menu and Option Page Setup Menu -- Exit current page and return to Main Menu
+	Increase the numeric value or make changes
-	Decrease the numeric value or make changes
F1 key	General help, only for Status Page Setup Menu and Option Page Setup Menu

Key	Function
F2/F3 key	Change color from total 3 colors. F2 to select color forward
F10	Save all the CMOS changes, only for Main Menu

**Table 5-1: BIOS Navigation Keys**

### 5.1.3 Getting Help

When **F1** is pressed a small help window describing the appropriate keys to use and the possible selections for the highlighted item appears. To exit the Help Window press **Esc** or the **F1** key again.

### 5.1.4 Unable to Reboot after Configuration Changes

If the computer cannot boot after changes to the system configuration is made, CMOS defaults. Use the jumper described in Chapter 4.

### 5.1.5 BIOS Menu Bar

The **menu bar** on top of the BIOS screen has the following main items:

- Main – Changes the basic system configuration.
- Advanced – Changes the advanced system settings.
- PCIPnP – Changes the advanced PCI/PnP settings
- Boot – Changes the system boot configuration.
- Security – Sets User and Supervisor Passwords.
- Chipset – Changes the chipset settings.
- Exit – Selects exit options and loads default settings

The following sections completely describe the configuration options found in the menu items at the top of the BIOS screen and listed above.

## KINO-G410 Mini-ITX Motherboard

### 5.2 Main

The **Main** BIOS menu (**BIOS Menu 1**) appears when the **BIOS Setup** program is entered. The **Main** menu gives an overview of the basic system information.

```

BIOS SETUP UTILITY
Main  Advanced  PCIPnP  Boot  Security  Chipset  Exit
-----
System Overview
-----
AMIBIOS
Version      :08.00.15
Build Date   :08/05/10
ID:          :SA16MR13

Processor
Intel(R) Pentium(R) Dual CPU E2160 @ 1.80GHz
Speed        :1800MHz
Count        :1

System Memory
Size         :990MB

System Time           [14:20:27]
System Date           [Tue 10/25/2011]

Use [ENTER], [TAB] or [SHIFT-TAB] to select a field.

Use [+] or [-] to configure system time.

<=> Select Screen
↑↓ Select Item
+ - Change Field
Tab Select Field
F1  General Help
F10 Save and Exit
ESC Exit

v02.61 ©Copyright 1985-2006, American Megatrends, Inc.

```

#### BIOS Menu 1: Main

##### → System Overview

The **System Overview** lists a brief summary of different system components. The fields in **System Overview** cannot be changed. The items shown in the system overview include:

- **AMI BIOS:** Displays auto-detected BIOS information
  - Version: Current BIOS version
  - Build Date: Date the current BIOS version was made
  - ID: Installed BIOS ID
- **Processor:** Displays auto-detected CPU specifications
  - Type: Names the currently installed processor
  - Speed: Lists the processor speed
  - Count: The number of CPUs on the motherboard
- **System Memory:** Displays the auto-detected system memory.
  - Size: Lists memory size

The **System Overview** field also has two user configurable fields:

➔ System Time [xx:xx:xx]

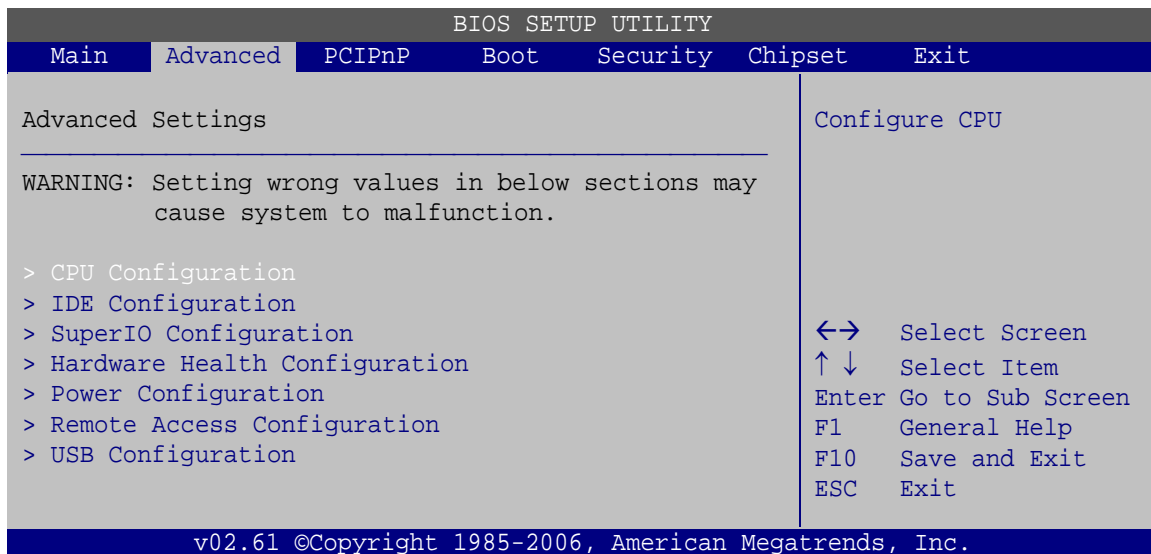
Use the **System Time** option to set the system time. Manually enter the hours, minutes and seconds.

➔ System Date [xx/xx/xx]

Use the **System Date** option to set the system date. Manually enter the day, month and year.

### 5.3 Advanced

Use the **Advanced** menu (**BIOS Menu 2**) to configure the CPU and peripheral devices through the following sub-menus:



#### BIOS Menu 2: Advanced



#### **WARNING:**

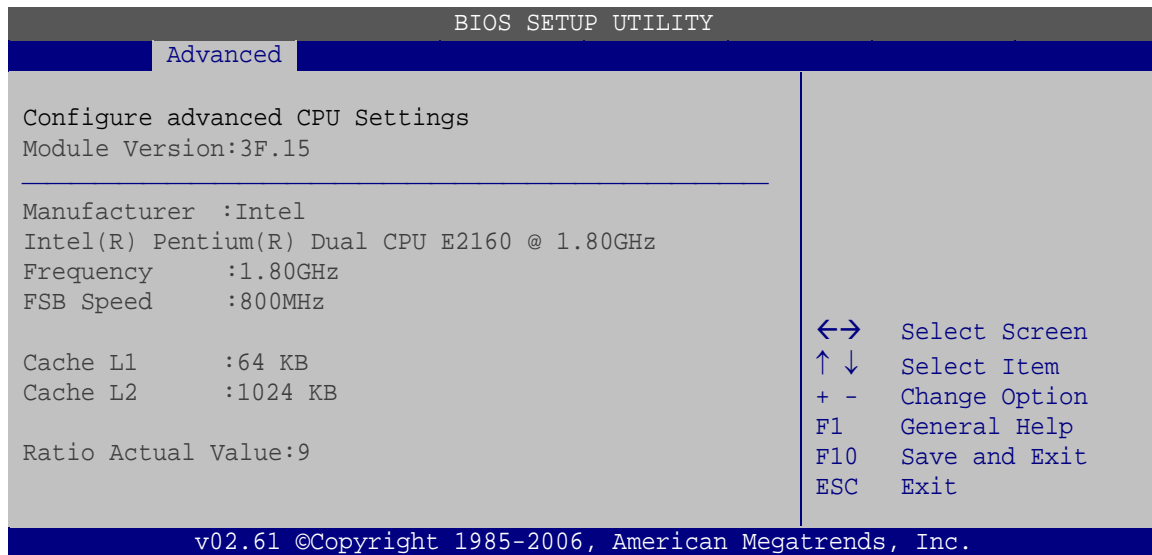
Setting the wrong values in the sections below may cause the system to malfunction. Make sure that the settings made are compatible with the hardware.



## KINO-G410 Mini-ITX Motherboard

### 5.3.1 CPU Configuration

Use the **CPU Configuration** menu (**BIOS Menu 3**) to view detailed CPU specifications and configure the CPU.



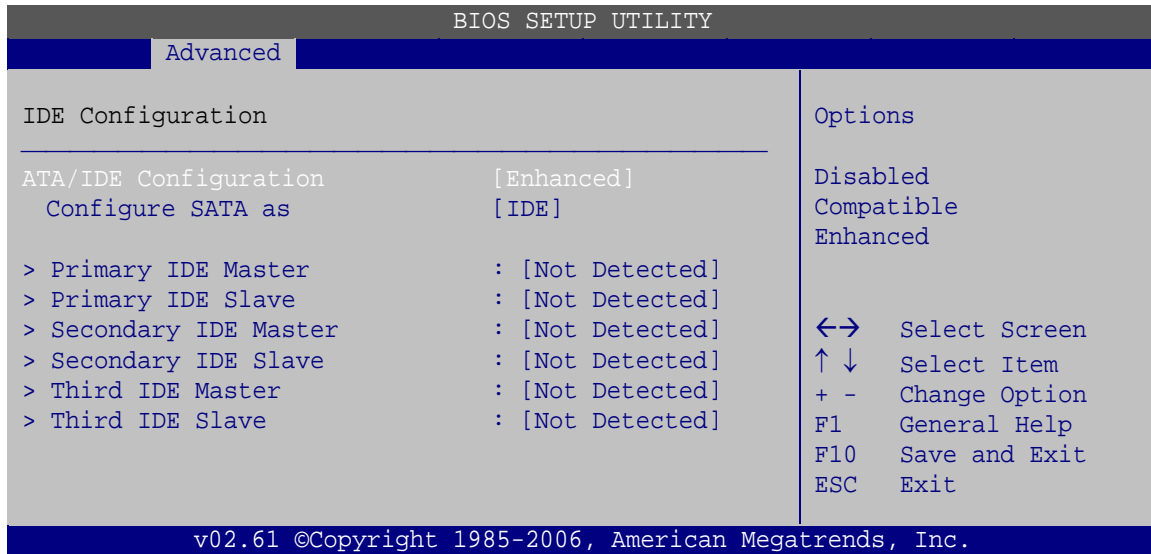
#### BIOS Menu 3: CPU Configuration

The CPU Configuration menu (**BIOS Menu 3**) lists the following CPU details:

- **Manufacturer:** Lists the name of the CPU manufacturer
- **Brand String:** Lists the brand name of the CPU being used
- **Frequency:** Lists the CPU processing speed
- **FSB Speed:** Lists the FSB speed
- **Cache L1:** Lists the CPU L1 cache size
- **Cache L2:** Lists the CPU L2 cache size
- **Ratio Actual Value:** Lists the ratio of the frequency to the clock speed

### 5.3.2 IDE Configuration

Use the **IDE Configuration** menu (**BIOS Menu 4**) to change and/or set the configuration of the IDE devices installed in the system.



#### BIOS Menu 4: IDE Configuration

##### → ATA/IDE Configuration [Enhanced]

Use the **ATA/IDE Configuration** option to configure the ATA/IDE controller.

- **Disabled**                      Disables the on-board ATA/IDE controller.
- **Compatible**                      Configures the on-board ATA/IDE controller to be in compatible mode. In this mode, a SATA channel will replace one of the IDE channels. This mode supports up to 4 storage devices.
- **Enhanced      DEFAULT**              Configures the on-board ATA/IDE controller to be in Enhanced mode. In this mode, IDE channels and SATA channels are separated. This mode supports up to 6 storage devices. Some legacy OS do not support this mode.

##### → Configure SATA as [IDE]

Use the **Configure SATA as** option to configure SATA devices as normal IDE devices.

- **IDE      DEFAULT**              Configures SATA devices as normal IDE device.

##### → IDE Master and IDE Slave

## KINO-G410 Mini-ITX Motherboard

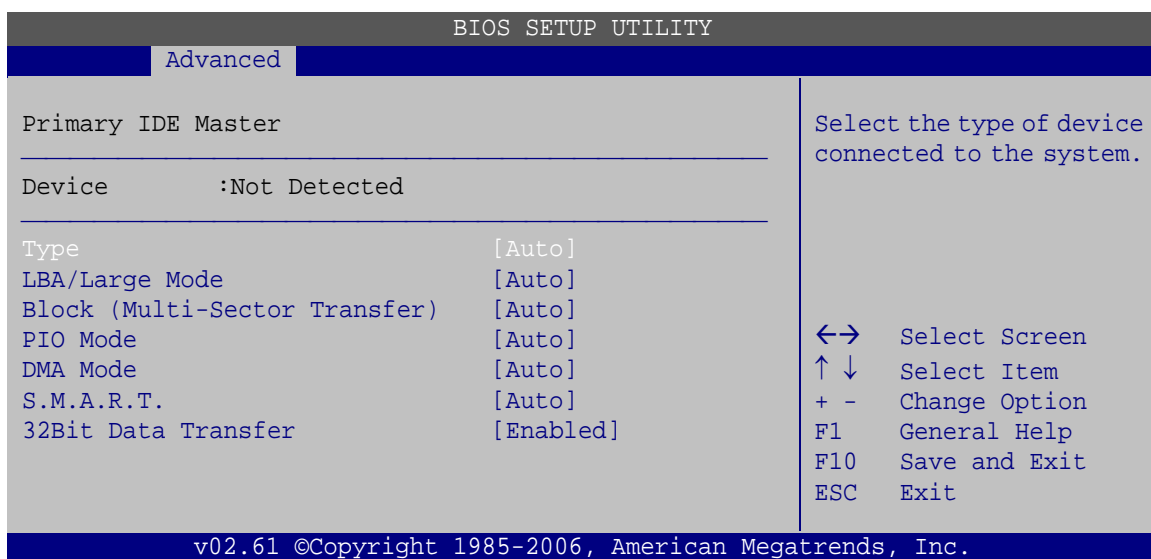
When entering setup, BIOS auto detects the presence of IDE devices. BIOS displays the status of the auto detected IDE devices. The following IDE devices are detected and are shown in the **IDE Configuration** menu:

- Primary IDE Master
- Primary IDE Slave
- Secondary IDE Master
- Secondary IDE Slave
- Third IDE Master
- Third IDE Slave

The **IDE Configuration** menu (**BIOS Menu 4**) allows changes to the configurations for the IDE devices installed in the system. If an IDE device is detected, and one of the above listed four BIOS configuration options is selected, the IDE configuration options shown in **Section 5.3.2.1** appear.

### 5.3.2.1 IDE Master, IDE Slave

Use the **IDE Master** and **IDE Slave** configuration menu to view both primary and secondary IDE device details and configure the IDE devices connected to the system.



### BIOS Menu 5: IDE Master and IDE Slave Configuration

➔ Auto-Detected Drive Parameters

The “grayed-out” items in the left frame are IDE disk drive parameters automatically detected from the firmware of the selected IDE disk drive. The drive parameters are listed as follows:

- **Device:** Lists the device type (e.g. hard disk, CD-ROM etc.)
- **Type:** Indicates the type of devices a user can manually select
- **Vendor:** Lists the device manufacturer
- **Size:** List the storage capacity of the device.
- **LBA Mode:** Indicates whether the LBA (Logical Block Addressing) is a method of addressing data on a disk drive is supported or not.
- **Block Mode:** Block mode boosts IDE drive performance by increasing the amount of data transferred. Only 512 bytes of data can be transferred per interrupt if block mode is not used. Block mode allows transfers of up to 64 KB per interrupt.
- **PIO Mode:** Indicates the PIO mode of the installed device.
- **Async DMA:** Indicates the highest Asynchronous DMA Mode that is supported.
- **Ultra DMA:** Indicates the highest Synchronous DMA Mode that is supported.
- **S.M.A.R.T.:** Indicates whether or not the Self-Monitoring Analysis and Reporting Technology protocol is supported.
- **32Bit Data Transfer:** Enables 32-bit data transfer.

➔ Type [Auto]

Use the **Type** BIOS option select the type of device the AMIBIOS attempts to boot from after the Power-On Self-Test (POST) is complete.

- |   |                            |  |
|---|----------------------------|--|
| ➔ | <b>Not Installed</b>       | BIOS is prevented from searching for an IDE disk drive on the specified channel.   |
| ➔ | <b>Auto</b> <b>DEFAULT</b> | The BIOS auto detects the IDE disk drive type attached to the specified channel. This setting should be used if an IDE hard disk drive is attached to the specified channel. |
| ➔ | <b>CD/DVD</b>              | The CD/DVD option specifies that an IDE CD-ROM drive is attached to the specified IDE channel. The   |

BIOS does not attempt to search for other types of IDE disk drives on the specified channel.

➔ **ARMD**

This option specifies an ATAPI Removable Media Device. These include, but are not limited to:

ZIP

LS-120

➔ **LBA/Large Mode [Auto]**

Use the **LBA/Large Mode** option to disable or enable BIOS to auto detects LBA (Logical Block Addressing). LBA is a method of addressing data on a disk drive. In LBA mode, the maximum drive capacity is 137 GB.

➔ **Disabled**

BIOS is prevented from using the LBA mode control on the specified channel.

➔ **Auto**      **DEFAULT**

BIOS auto detects the LBA mode control on the specified channel.

➔ **Block (Multi Sector Transfer) [Auto]**

Use the **Block (Multi Sector Transfer)** to disable or enable BIOS to auto detect if the device supports multi-sector transfers.

➔ **Disabled**

BIOS is prevented from using Multi-Sector Transfer on the specified channel. The data to and from the device occurs one sector at a time.

➔ **Auto**      **DEFAULT**

BIOS auto detects Multi-Sector Transfer support on the drive on the specified channel. If supported the data transfer to and from the device occurs multiple sectors at a time.

## → PIO Mode [Auto]

Use the **PIO Mode** option to select the IDE PIO (Programmable I/O) mode program timing cycles between the IDE drive and the programmable IDE controller. As the PIO mode increases, the cycle time decreases.

- **Auto**    **DEFAULT**    BIOS auto detects the PIO mode. Use this value if the IDE disk drive support cannot be determined.
- **0**                    PIO mode 0 selected with a maximum transfer rate of 3.3MBps
- **1**                    PIO mode 1 selected with a maximum transfer rate of 5.2MBps
- **2**                    PIO mode 2 selected with a maximum transfer rate of 8.3MBps
- **3**                    PIO mode 3 selected with a maximum transfer rate of 11.1MBps
- **4**                    PIO mode 4 selected with a maximum transfer rate of 16.6MBps  
(This setting generally works with all hard disk drives manufactured after 1999. For other disk drives, such as IDE CD-ROM drives, check the specifications of the drive.)

## → DMA Mode [Auto]

Use the **DMA Mode** BIOS selection to adjust the DMA mode options.

- **Auto**            **DEFAULT**    BIOS auto detects the DMA mode. Use this value if the IDE disk drive support cannot be determined.
- **SWDMA0**            Single Word DMA mode 0 selected with a maximum data transfer rate of 2.1MBps
- **SWDMA1**            Single Word DMA mode 1 selected with a maximum data transfer rate of 4.2MBps
- **SWDMA2**            Single Word DMA mode 2 selected with a maximum data transfer rate of 8.3MBps
- **MWDMA0**            Multi Word DMA mode 0 selected with a maximum data transfer rate of 4.2MBps
- **MWDMA1**            Multi Word DMA mode 1 selected with a maximum data transfer rate of 13.3MBps

## KINO-G410 Mini-ITX Motherboard

- ➔ **MWDMA2** Multi Word DMA mode 2 selected with a maximum data transfer rate of 16.6MBps
- ➔ **UDMA1** Ultra DMA mode 0 selected with a maximum data transfer rate of 16.6MBps
- ➔ **UDMA1** Ultra DMA mode 1 selected with a maximum data transfer rate of 25MBps
- ➔ **UDMA2** Ultra DMA mode 2 selected with a maximum data transfer rate of 33.3MBps
- ➔ **UDMA3** Ultra DMA mode 3 selected with a maximum data transfer rate of 44MBps (To use this mode, it is required that an 80-conductor ATA cable is used.)
- ➔ **UDMA4** Ultra DMA mode 4 selected with a maximum data transfer rate of 66.6MBps (To use this mode, it is required that an 80-conductor ATA cable is used.)
- ➔ **UDMA5** Ultra DMA mode 5 selected with a maximum data transfer rate of 99.9MBps (To use this mode, it is required that an 80-conductor ATA cable is used.)

### ➔ S.M.A.R.T [Auto]

Use the **S.M.A.R.T** option to auto-detect, disable or enable Self-Monitoring Analysis and Reporting Technology (SMART) on the drive on the specified channel. **S.M.A.R.T** predicts impending drive failures. The **S.M.A.R.T** BIOS option enables or disables this function.

- ➔ **Auto**      **DEFAULT**      BIOS auto detects HDD SMART support.
  - ➔ **Disabled**      Prevents BIOS from using the HDD SMART feature.
  - ➔ **Enabled**      Allows BIOS to use the HDD SMART feature
- ➔ **32Bit Data Transfer** [Enabled]

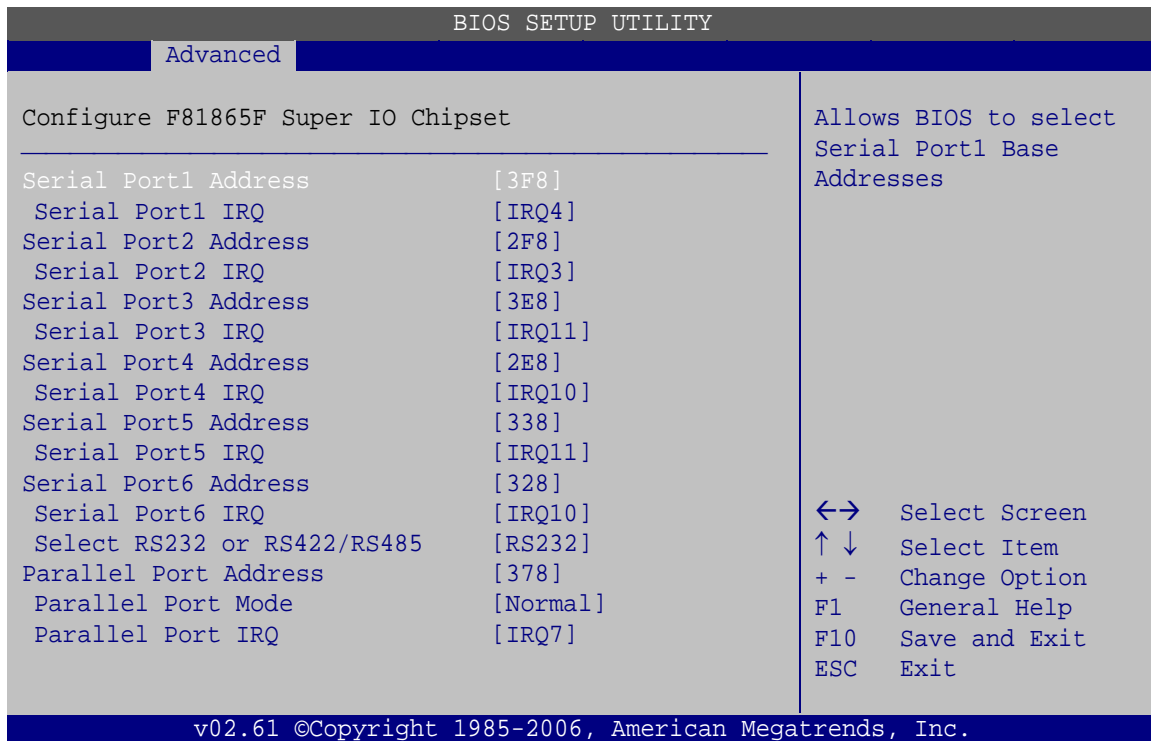
Use the **32Bit Data Transfer** BIOS option to enables or disable 32-bit data transfers.

- ➔ **Disabled**      Prevents the BIOS from using 32-bit data transfers.

- ➔ **Enabled**    **DEFAULT**    Allows BIOS to use 32-bit data transfers on supported hard disk drives.

### 5.3.3 Super IO Configuration

Use the **Super IO Configuration** menu (**BIOS Menu 6**) to set or change the configurations for the serial ports.



#### BIOS Menu 6: Super IO Configuration

- ➔ Serial Port1 Address [3F8]

Use the **Serial Port1 Address** option to select the Serial Port 1 base address.

- ➔ **Disabled**                      No base address is assigned to Serial Port 1
- ➔ **3F8**                      **DEFAULT**    Serial Port 1 I/O port address is 3F8
- ➔ **2F8**                      Serial Port 1 I/O port address is 2F8
- ➔ Serial Port1 IRQ [IRQ4]



## KINO-G410 Mini-ITX Motherboard

Use the **Serial Port1 IRQ** option to select the interrupt address for serial port 1.

- **IRQ4**      **DEFAULT**    Serial port 1 IRQ address is IRQ4
- **IRQ3**                      Serial port 1 IRQ address is IRQ3

### → Serial Port2 Address [2F8]

Use the **Serial Port2 Address** option to select the Serial Port 2 base address.

- **Disabled**                      No base address is assigned to Serial Port 2
- **3F8**                              Serial Port 2 I/O port address is 3F8
- **2F8**              **DEFAULT**    Serial Port 2 I/O port address is 2F8

### → Serial Port2 IRQ [IRQ3]

Use the **Serial Port2 IRQ** option to select the interrupt address for serial port 2

- **IRQ4**                              Serial port 2 IRQ address is IRQ4
- **IRQ3**              **DEFAULT**    Serial port 2 IRQ address is IRQ3

### → Serial Port3 Address [3E8]

Use the **Serial Port3 Address** option to select the Serial Port 3 base address.

- **Disabled**                      No base address is assigned to Serial Port 3
- **3E8**              **DEFAULT**    Serial Port 3 I/O port address is 3E8
- **2E8**                              Serial Port 3 I/O port address is 2E8

### → Serial Port3 IRQ [IRQ11]

Use the **Serial Port3 IRQ** option to select the interrupt address for serial port 3.

- **IRQ10**                              Serial port 3 IRQ address is IRQ10
- **IRQ11**              **DEFAULT**    Serial port 3 IRQ address is IRQ11

→ Serial Port4 Address s [2E8]

Use the **Serial Port4 Address** option to select the Serial Port 4 base address.

- **Disabled** No base address is assigned to Serial Port 4
- **3E8** Serial Port 4 I/O port address is 3E8
- **2E8** **DEFAULT** Serial Port 4 I/O port address is 2E8

→ Serial Port4 IRQ [IRQ10]

Use the **Serial Port4 IRQ** option to select the interrupt address for serial port 4.

- **IRQ10** **DEFAULT** Serial port 4 IRQ address is IRQ10
- **IRQ11** Serial port 4 IRQ address is IRQ11

→ Serial Port5 Address s [338]

Use the **Serial Port5 Address** option to select the Serial Port 5 base address.

- **Disabled** No base address is assigned to Serial Port 5
- **338** **DEFAULT** Serial Port 5 I/O port address is 338
- **328** Serial Port 5 I/O port address is 328

→ Serial Port5 IRQ [IRQ11]

Use the **Serial Port5 IRQ** option to select the interrupt address for serial port 5.

- **IRQ10** Serial port 5 IRQ address is IRQ10
- **IRQ11** **DEFAULT** Serial port 5 IRQ address is IRQ11

→ Serial Port6 Address s [328]

Use the **Serial Port6 Address** option to select the Serial Port 6 base address.

- **Disabled** No base address is assigned to Serial Port 6
- **338** Serial Port 6 I/O port address is 338

## KINO-G410 Mini-ITX Motherboard

→ **328**      **DEFAULT**    Serial Port 6 I/O port address is 328

→ Serial Port6 IRQ [IRQ10]

Use the **Serial Port6 IRQ** option to select the interrupt address for serial port 6.

→ **IRQ10**      **DEFAULT**    Serial port 6 IRQ address is IRQ10

→ **IRQ11**                      Serial port 6 IRQ address is IRQ11

→ Select RS232 or RS422/RS485 [RS232]

Use the **Select RS232 or RS422/RS485** option to select the Serial Port 2 signaling mode.

→ **RS232**              **DEFAULT**    Serial Port 2 signaling mode is RS-232

→ **RS422/RS485**                      Serial Port 2 signaling mode is RS-422/RS-485

→ IR Function [COM6]

Use the **IR Function** option to select the transmitting and receiving mode for the sixth serial port.

→ **COM6**      **DEFAULT**    Serial Port 6 mode is normal

→ **IR**                      Serial Port 6 mode is IR

→ Parallel Port Address [378]

Use the **Parallel Port Address** option to select the parallel port base address.

→ **Disabled**                      No base address is assigned to the Parallel Port

→ **378**      **DEFAULT**    Parallel Port I/O port address is 378

→ **278**                      Parallel Port I/O port address is 278

→ **3BC**                      Parallel Port I/O port address is 3BC

→ Parallel Port Mode [Normal]

Use the **Parallel Port Mode** option to select the mode the parallel port operates in.

- **Normal**      **DEFAULT**      The normal parallel port mode is the standard mode for parallel port operation.
- **Bi-Directional**      Parallel port outputs are 8-bits long. Inputs are accomplished by reading 4 of the 8 bits on the status register.
- **ECP**      The parallel port operates in the extended capabilities port (ECP) mode. The ECP mode supports bi-directional communication between the system and the parallel port device and the transmission rates between the two are much faster than the Normal mode
- **EPP**      The parallel port operates in the enhanced parallel port mode (EPP). The EPP mode supports bi-directional communication between the system and the parallel port device and the transmission rates between the two are much faster than the Normal mode.
- **ECP&EPP**      The parallel port operates in the extended capabilities port (ECP) mode. The ECP mode supports bi-directional communication between the system and the parallel port device and the transmission rates between the two are much faster than the Normal mode  
  
The parallel port is also be compatible with EPP devices described above
- **Parallel Port IRQ [IRQ7]**

Use the **Parallel Port IRQ** selection to set the parallel port interrupt address.

- **IRQ5**      IRQ5 is assigned as the parallel port interrupt address
- **IRQ7**      **DEFAULT**      IRQ7 is assigned as the parallel port interrupt address

## KINO-G410 Mini-ITX Motherboard

### 5.3.4 Hardware Health Configuration

The **Hardware Health Configuration** menu (**BIOS Menu 7**) shows the operating temperature, fan speed and system voltages.

```

BIOS SETUP UTILITY
-----
Advanced
-----
Hardware Health Configuration
-----
CPU FAN1 Mode Setting          [Auto Fan by RPM]
CPU Temp. Limit of Highest     [050]
CPU Temp. Limit of Second      [040]
CPU Temp. Limit of Third       [030]
CPU Temp. Limit of Lowest      [020]
CPU FAN1 Highest Setting       [100]
CPU FAN1 Second Setting        [080]
CPU FAN1 Third Setting         [070]
CPU FAN1 Fourth Setting        [060]
CPU FAN1 Lowest Setting        [050]
SYS FAN1 Mode Setting          [Auto Fan by RPM]
SYS Temp. Limit of Highest     [050]
SYS Temp. Limit of Second      [040]
SYS Temp. Limit of Third       [030]
SYS Temp. Limit of Lowest      [020]
SYS FAN1 Highest Setting       [100]
SYS FAN1 Second Setting        [080]
SYS FAN1 Third Setting         [070]
SYS FAN1 Fourth Setting        [060]
SYS FAN1 Lowest Setting        [050]
-----
CPU Temperature                 :16°C/60°F
System Temperature              :28°C/82°F

CPU Fan Speed                   :4918 RPM
SYS Fan1 Speed                  :N/A

VCC3                           :3.312 V
VCC_Core                        :1.312 V
VIN_1.5V                       :1.560 V
VIN2_5V                        :5.016 V
VIN3_12V                       :11.968 V
VSB                             :3.392 V
VBAT                           :3.312 V

<=> Select Screen
↑↓ Select Item
+ - Change Option
F1  General Help
F10 Save and Exit
ESC Exit

v02.61 ©Copyright 1985-2006, American Megatrends, Inc.
  
```

**BIOS Menu 7: Hardware Health Configuration**

→ CPU FAN1 Mode Setting [Auto Fan by RPM]

Use the **CPU FAN1 Mode Setting** option to configure the CPU Fan.

- **Auto Fan by DEFAULT RPM** The fan adjusts its speed using Auto Fan by RPM settings
- **Auto Fan by Duty-Cycle** The fan adjusts its speed using Auto Fan by Duty-Cycle settings
- **Manual Mode by RPM** The fan spins at the speed set in Manual Mode by RPM settings
- **Manual Mode by Duty-Cycle** The fan spins at the speed set in Manual Mode by Duty-Cycle settings

→ CPU Temp. Limit of Highest / Second / Third / Lowest [n]

Use the + or – key to change the **CPU Temp. Limit of Highest / Second / Third / Lowest** value. Enter a decimal number between 0 and 127.

→ CPU Fan1 Highest Setting [100]

F81865 only support full speed in highest speed value.

→ CPU Fan1 Second / Third / Fourth / Lowest Setting [n]

Use the + or – key to change the **CPU Fan Second / Third / Fourth / Lowest** speed. Enter a decimal number between 12 and 100.

→ SYS FAN1 Mode Setting [Auto Fan by RPM]

Use the **SYS FAN1 Mode Setting** option to configure the NB Fan.

- **Auto Fan by DEFAULT RPM** The fan adjusts its speed using Auto Fan by RPM settings
- **Auto Fan by Duty-Cycle** The fan adjusts its speed using Auto Fan by Duty-Cycle settings

## KINO-G410 Mini-ITX Motherboard

- ➔ **Manual Mode by RPM**                      The fan spins at the speed set in Manual Mode by RPM settings
- ➔ **Manual Mode by Duty-Cycle**                      The fan spins at the speed set in Manual Mode by Duty-Cycle settings
  
- ➔ SYS Temp. Limit of Highest / Second / Third / Lowest [n]
 

Use the + or – key to change the **NB Temp. Limit of Highest / Second / Third / Lowest** value. Enter a decimal number between 0 and 127.
  
- ➔ SYS Fan1 Highest Setting [100]
 

F81865 only support full speed in highest speed value.
  
- ➔ SYS Fan1 Second / Third / Fourth / Lowest Setting [n]
 

Use the + or – key to change the **NB Fan Second / Third / Fourth / Lowest** speed. Enter a decimal number between 12 and 100.
  
- ➔ Monitored Values
 

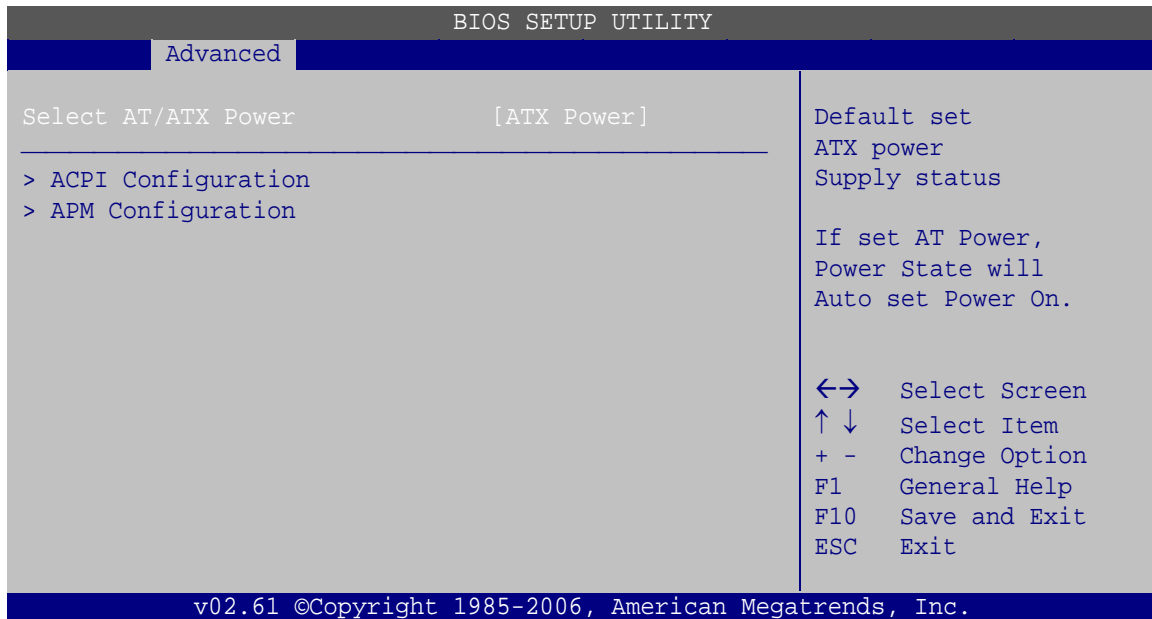
The following system parameters and values are shown. The system parameters that are monitored are:

  - The following system temperatures are monitored:
    - CPU Temperature
    - System Temperature
  - The following fan speeds are monitored:
    - CPU Fan Speed
    - SYS Fan1 Speed
  - The following core voltages are monitored:
    - VCC3
    - VCC\_Core
    - VIN1\_1.5V
    - VIN2\_5V
    - VIN3\_12V
    - VSB

- VBAT

### 5.3.5 Power Configuration

The **Power Configuration** menu (**BIOS Menu 8**) configures the Advanced Configuration and Power Interface (ACPI) and Power Management (APM) options.



#### **BIOS Menu 8: Power Configuration**

➔ Select AT/ATX Power [ATX Power]

Sets the behavior of the power.

- AT Power
- ATX Power           **DEFAULT**

When the **Select AT/ATX Power** option is set to **ATX Power**, the following sub-menus appear.

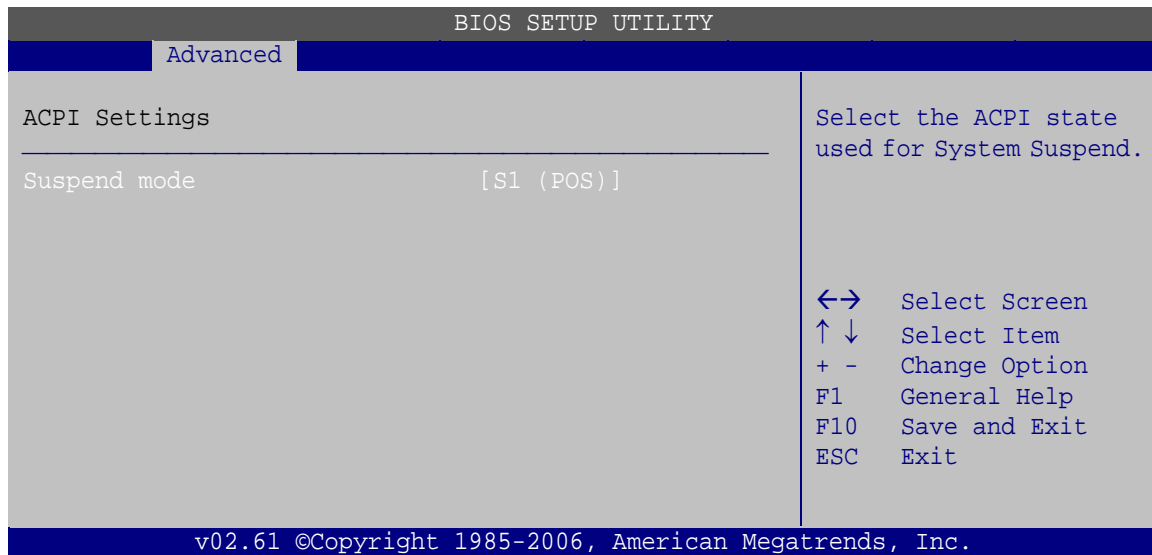
- ACPI Configuration
- APM Configuration



## KINO-G410 Mini-ITX Motherboard

### 5.3.5.1 ACPI configuration

The **ACPI Configuration** menu (**BIOS Menu 9**) configures the Advanced Configuration and Power Interface (ACPI).



#### BIOS Menu 9: ACPI Configuration

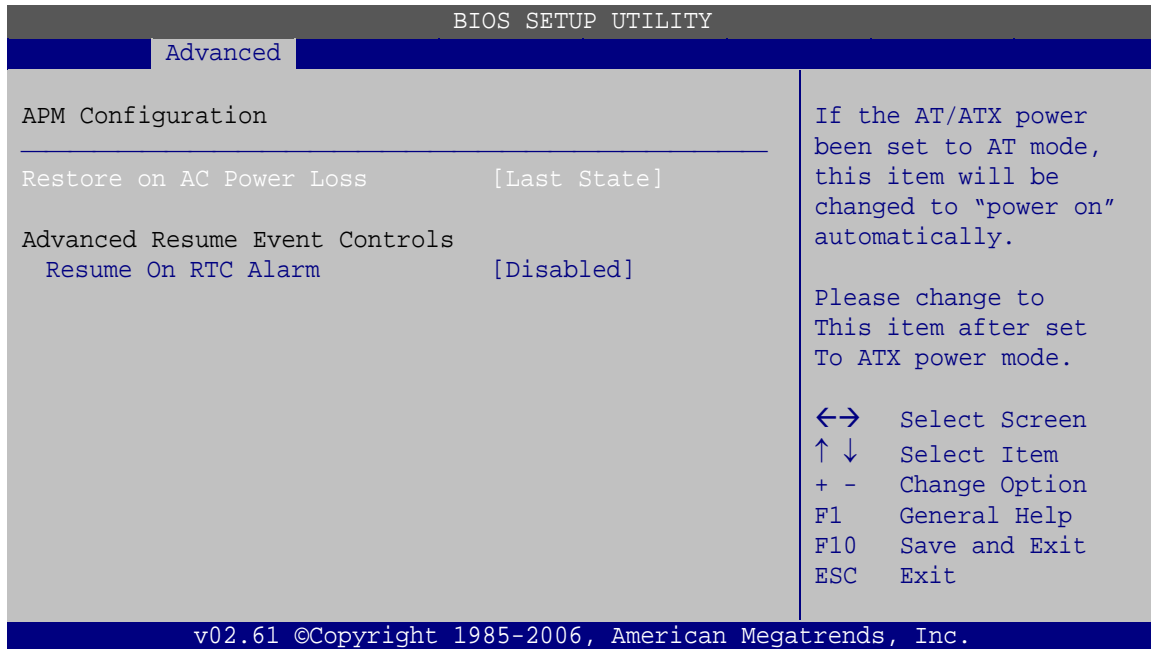
##### → Suspend mode [S1 (POS)]

Use the **Suspend mode** BIOS option to specify the sleep state the system enters when it is not being used.

- **S1 (POS) DEFAULT** System appears off. The CPU is stopped; RAM is refreshed; the system is running in a low power mode.
- **S3 (STR)** System appears off. The CPU has no power; RAM is in slow refresh; the power supply is in a reduced power mode.

### 5.3.5.2 APM Configuration

The **APM Configuration** menu (**BIOS Menu 10**) allows the advanced power management options to be configured.



### BIOS Menu 10: Advanced Power Management Configuration

#### → Restore on AC Power Loss [Last State]

Use the **Restore on AC Power Loss** BIOS option to specify what state the system returns to if there is a sudden loss of power to the system.

- **Power Off**                      The system remains turned off
- **Power On**                        The system turns on
- **Last State**    **DEFAULT**      The system returns to its previous state. If it was on, it turns itself on. If it was off, it remains off.

#### → Resume On RTC Alarm [Disabled]

Use the **Resume On RTC Alarm** option to specify the time the system should be roused from a suspended state.

- **Disabled**    **DEFAULT**      The real time clock (RTC) cannot generate a wake event
- **Enabled**                        If selected, the following appears with values that can be selected:

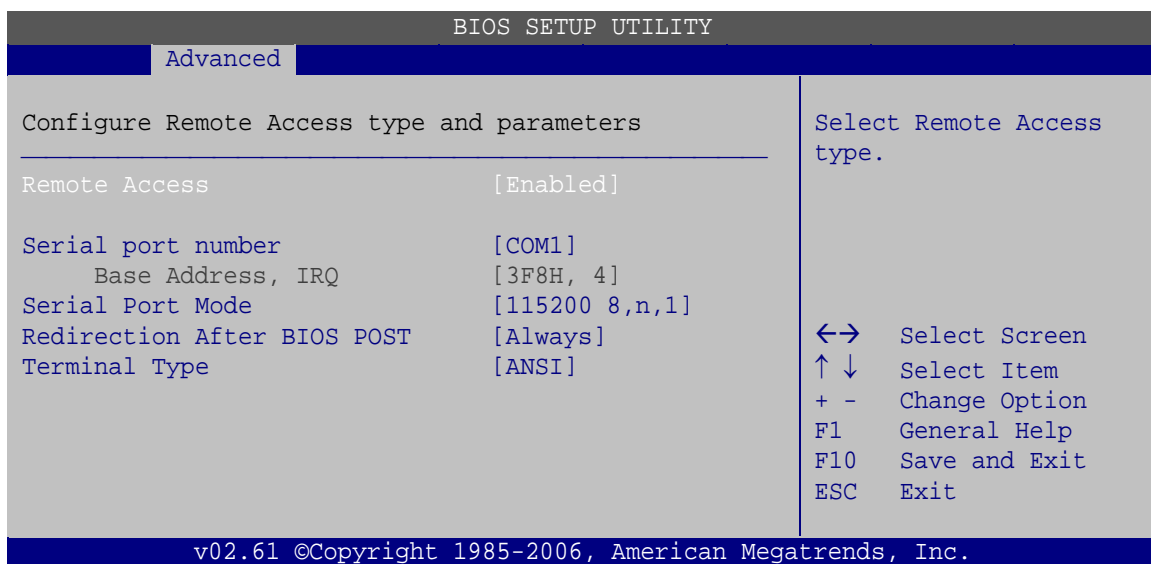
RTC Alarm Date (Days)

System Time

After setting the alarm, the computer turns itself on from a suspend state when the alarm goes off.

### 5.3.6 Remote Access Configuration

Use the **Remote Access Configuration** menu (**BIOS Menu 11**) to configure remote access parameters. The **Remote Access Configuration** is an AMIBIOS feature and allows a remote host running a terminal program to display and configure the BIOS settings.



#### BIOS Menu 11: Remote Access Configuration

➔ Remote Access [Disabled]

Use the **Remote Access** option to enable or disable access to the remote functionalities of the system.

➔ **Disabled**      **DEFAULT**      Remote access is disabled.

➔ **Enabled**      Remote access configuration options shown below appear:

Serial port number

Serial Port Mode

Redirection after BIOS POST

Terminal Type

These configuration options are discussed below.

When the **Remote Access** option is set to **Enabled**, the following sub-menus appear.

- Serial port number
- Base Address, IRQ
- Serial Port Mode
- Redirection After BIOS POST
- Terminal Type

➔ Serial port number [COM1]

Use the **Serial port number** option to select the serial port used for remote access.

- |   |             |                |  |
|---|-------------|----------------|--|
| ➔ | <b>COM1</b> | <b>DEFAULT</b> | System is remotely accessed through COM1 |
| ➔ | <b>COM2</b> |                | System is remotely accessed through COM2 |
| ➔ | <b>COM3</b> |                | System is remotely accessed through COM3 |
| ➔ | <b>COM4</b> |                | System is remotely accessed through COM4 |
| ➔ | <b>COM5</b> |                | System is remotely accessed through COM5 |
| ➔ | <b>COM6</b> |                | System is remotely accessed through COM6 |

**NOTE:** Make sure the selected COM port is enabled through the Super I/O configuration menu.

➔ Base Address, IRQ [3F8h,4]

The **Base Address, IRQ** option cannot be configured and only shows the interrupt address of the serial port listed above.

➔ Serial Port Mode [115200 8,n,1]

## KINO-G410 Mini-ITX Motherboard

Use the **Serial Port Mode** option to select baud rate through which the console redirection is made. The following configuration options are available

- 115200 8,n,1 DEFAULT
- 57600 8,n,1
- 38400 8,n,1
- 19200 8,n,1
- 09600 8,n,1



### NOTE:

Identical baud rate setting must be set on the host (a management computer running a terminal software) and the slave

### → Redirection After BIOS POST [Always]

Use the **Redirection After BIOS POST** option to specify when console redirection should occur.

- |   |                    |                |  |
|---|--------------------|----------------|--|
| → | <b>Disabled</b>    |                | The console is not redirected after POST                               |
| → | <b>Boot Loader</b> |                | Redirection is active during POST and during Boot Loader               |
| → | <b>Always</b>      | <b>DEFAULT</b> | Redirection is always active (Some OSes may not work if set to Always) |

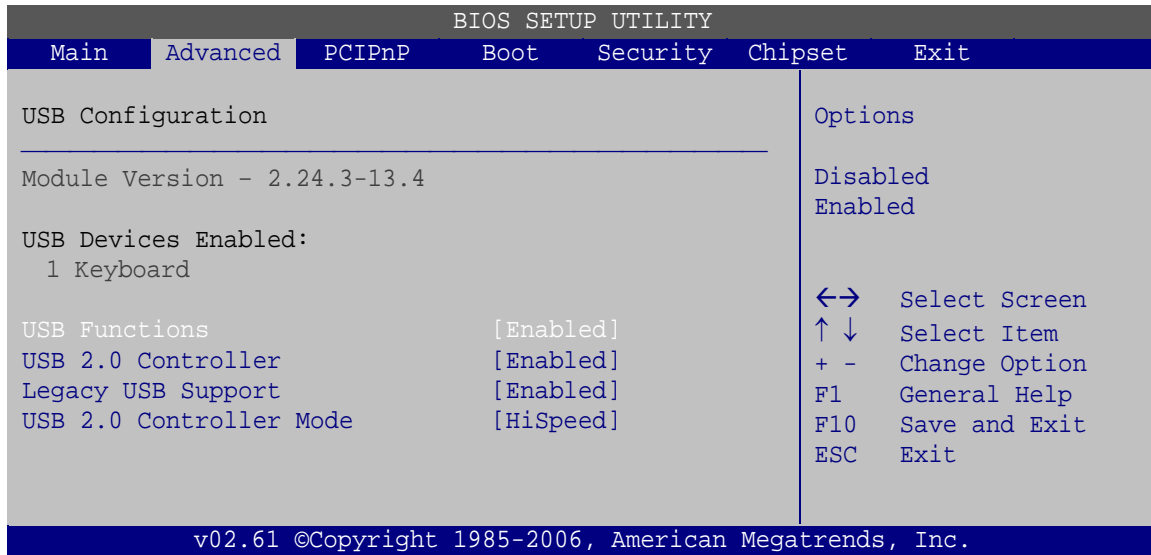
### → Terminal Type [ANSI]

Use the **Terminal Type** BIOS option to specify the remote terminal type.

- |   |                |                |                                     |
|---|----------------|----------------|-------------------------------------|
| → | <b>ANSI</b>    | <b>DEFAULT</b> | The target terminal type is ANSI    |
| → | <b>VT100</b>   |                | The target terminal type is VT100   |
| → | <b>VT-UTF8</b> |                | The target terminal type is VT-UTF8 |

### 5.3.7 USB Configuration

Use the **USB Configuration** menu (**BIOS Menu 12**) to read USB configuration information and configure the USB settings.



#### BIOS Menu 12: USB Configuration

➔ USB Functions [Enabled]

Use the **USB Functions** option to enable or disable the USB controllers.

- ➔ **Disabled** USB controllers are enabled
- ➔ **Enabled** **DEFAULT** USB controllers are disabled

➔ USB 2.0 Controller [Enabled]

The **USB 2.0 Controller** BIOS option enables or disables the USB 2.0 controller

- ➔ **Disabled** USB function disabled
- ➔ **Enabled** **DEFAULT** USB function enabled

➔ Legacy USB Support [Enabled]

Use the **Legacy USB Support** BIOS option to enable USB mouse and USB keyboard support.

## KINO-G410 Mini-ITX Motherboard

Normally if this option is not enabled, any attached USB mouse or USB keyboard does not become available until a USB compatible operating system is fully booted with all USB drivers loaded. When this option is enabled, any attached USB mouse or USB keyboard can control the system even when there is no USB driver loaded onto the system.

- ➔ **Disabled** Legacy USB support disabled
- ➔ **Enabled**     **DEFAULT** Legacy USB support enabled
- ➔ **Auto** Legacy USB support disabled if no USB devices are connected

### ➔ USB 2.0 Controller Mode [HiSpeed]

The **USB2.0 Controller Mode** BIOS option sets the speed of the USB2.0 controller.

- ➔ **FullSpeed** The controller is capable of operating at full speed 12 Mb/s
- ➔ **HiSpeed**     **DEFAULT** The controller is capable of operating at high speed 480 Mb/s

## 5.4 PCI/PnP

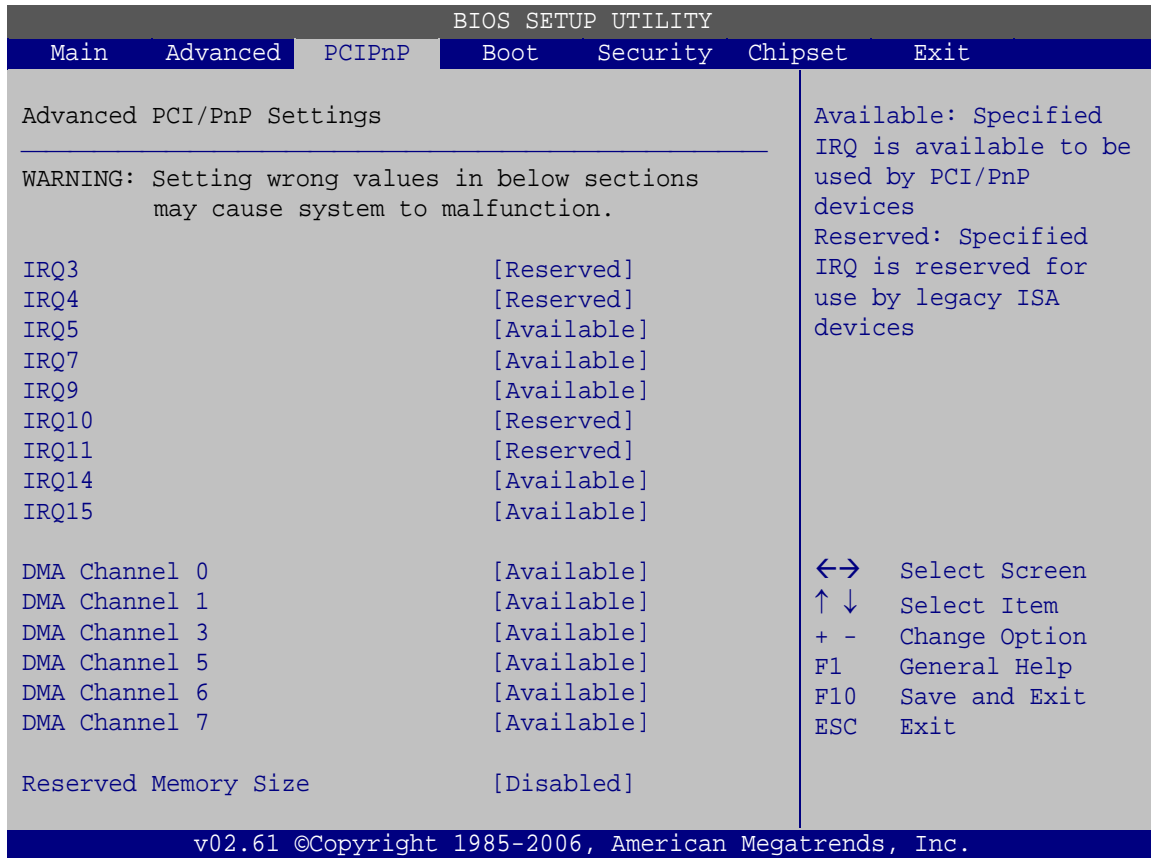
Use the **PCI/PnP** menu (**BIOS Menu 13**) to configure advanced PCI and PnP settings.



### **WARNING:**

Setting wrong values for the BIOS selections in the PCIPnP BIOS menu may cause the system to malfunction.

---



### BIOS Menu 13: PCI/PnP Configuration

→ IRQ# [Available]

Use the **IRQ#** address to specify what IRQs can be assigned to a particular peripheral device.

→ **Available**    **DEFAULT**    The specified IRQ is available to be used by PCI/PnP devices

→ **Reserved**    The specified IRQ is reserved for use by Legacy ISA devices

Available IRQ addresses are:

- IRQ3
- IRQ4
- IRQ5
- IRQ7



## KINO-G410 Mini-ITX Motherboard

- IRQ9
- IRQ10
- IRQ 11
- IRQ 14
- IRQ 15

### → DMA Channel# [Available]

Use the **DMA Channel#** option to assign a specific DMA channel to a particular PCI/PnP device.

- **Available**     **DEFAULT**     The specified DMA is available to be used by PCI/PnP devices
- **Reserved**                     The specified DMA is reserved for use by Legacy ISA devices

Available DMA Channels are:

- DM Channel 0
- DM Channel 1
- DM Channel 3
- DM Channel 5
- DM Channel 6
- DM Channel 7

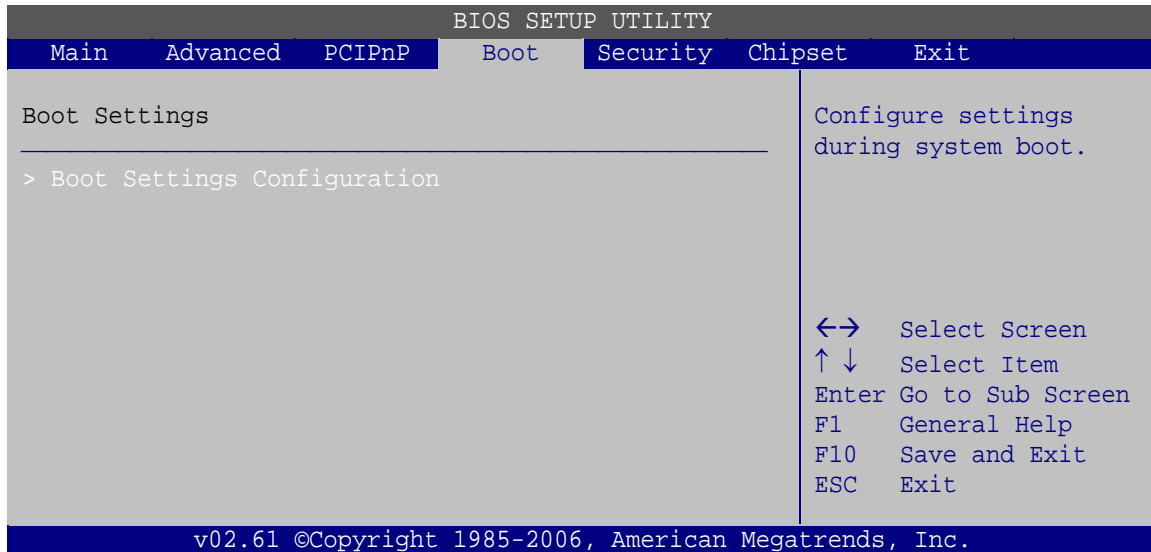
### → Reserved Memory Size [Disabled]

Use the **Reserved Memory Size** BIOS option to specify the amount of memory that should be reserved for legacy ISA devices.

- **Disabled**     **DEFAULT**     No memory block reserved for legacy ISA devices
- **16K**                             16KB reserved for legacy ISA devices
- **32K**                             32KB reserved for legacy ISA devices
- **64K**                             54KB reserved for legacy ISA devices

## 5.5 Boot

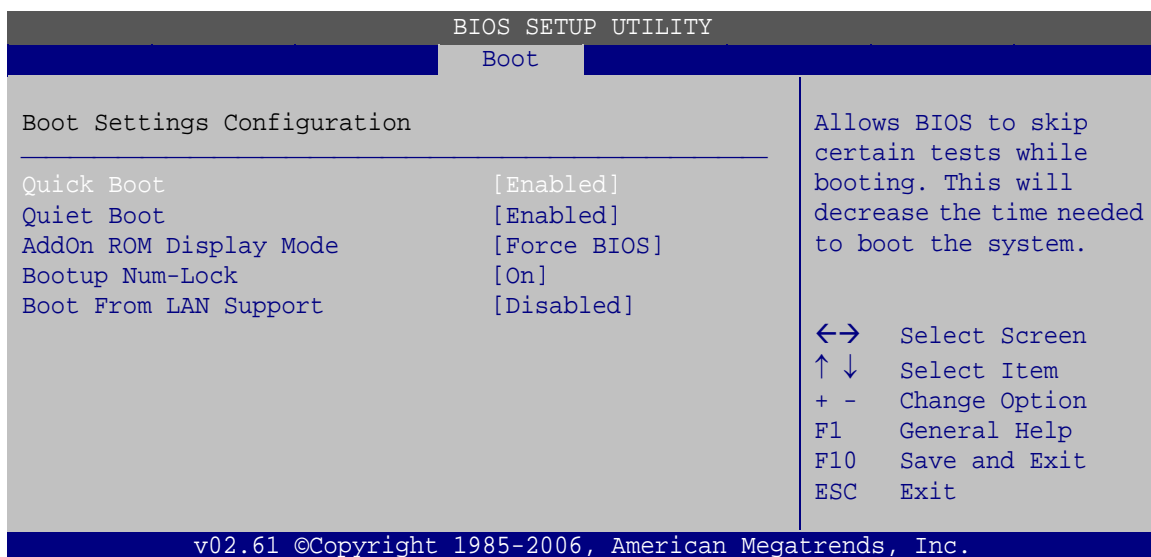
Use the **Boot menu (BIOS Menu 14)** to configure system boot options.



### BIOS Menu 14: Boot

#### 5.5.1 Boot Settings Configuration

Use the **Boot Settings Configuration menu (BIOS Menu 15)** to configure advanced system boot options.



### BIOS Menu 15: Boot Settings Configuration

## KINO-G410 Mini-ITX Motherboard

### → Quick Boot [Enabled]

Use the **Quick Boot** BIOS option to make the computer speed up the boot process.

- **Disabled** No POST procedures are skipped
- **Enabled** **DEFAULT** Some POST procedures are skipped to decrease the system boot time

### → Quiet Boot [Enabled]

Use the **Quiet Boot** BIOS option to select the screen display when the system boots.

- **Disabled** Normal POST messages displayed
- **Enabled** **DEFAULT** OEM Logo displayed instead of POST messages

### → AddOn ROM Display Mode [Force BIOS]

The **AddOn ROM Display Mode** option allows add-on ROM (read-only memory) messages to be displayed.

- **Force BIOS** **DEFAULT** Allows the computer system to force a third party BIOS to display during system boot.
- **Keep Current** Allows the computer system to display the information during system boot.

### → Bootup Num-Lock [On]

The **Bootup Num-Lock** BIOS option allows the Number Lock setting to be modified during boot up.

- **Off** Does not enable the keyboard Number Lock automatically. To use the 10-keys on the keyboard, press the Number Lock key located on the upper left-hand corner of the 10-key pad. The Number Lock LED on the keyboard lights up when the Number Lock is engaged.
- **On** **DEFAULT** Allows the Number Lock on the keyboard to be enabled

automatically when the computer system boots up. This allows the immediate use of the 10-key numeric keypad located on the right side of the keyboard. To confirm this, the Number Lock LED light on the keyboard is lit.

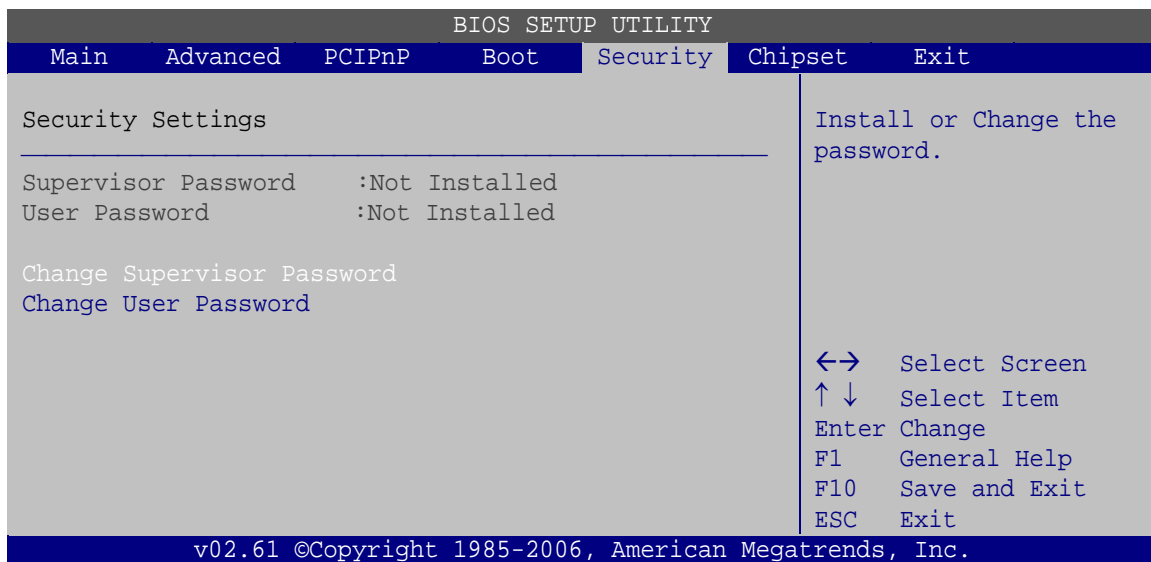
➔ **Boot From LAN Support [Disabled]**

The **Boot From LAN Support** option enables the system to be booted from a remote system.

- ➔ **Disabled**      **DEFAULT**      Cannot be booted from a remote system through the LAN.
- ➔ **Enabled**                      Can be booted from a remote system through the LAN.

## 5.6 Security

Use the **Security** menu (**BIOS Menu 16**) to set system and user passwords.



### BIOS Menu 16: Security

➔ **Change Supervisor Password**

Use the **Change Supervisor Password** to set or change a supervisor password. The default for this option is **Not Installed**. If a supervisor password must be installed, select

## KINO-G410 Mini-ITX Motherboard

this field and enter the password. After the password has been added, **Install** appears next to **Change Supervisor Password**.

### → Change User Password

Use the **Change User Password** to set or change a user password. The default for this option is **Not Installed**. If a user password must be installed, select this field and enter the password. After the password has been added, **Install** appears next to **Change User Password**.

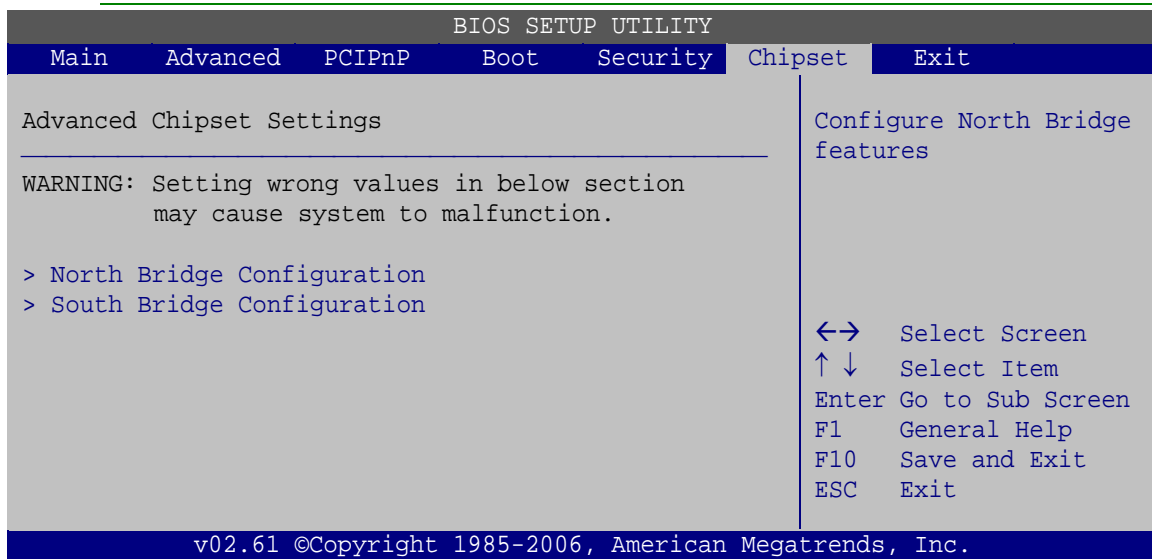
## 5.7 Chipset

Use the **Chipset** menu (**BIOS Menu 17**) to access the NorthBridge and SouthBridge configuration menus.



### **WARNING!**

Setting the wrong values for the Chipset BIOS selections in the Chipset BIOS menu may cause the system to malfunction.

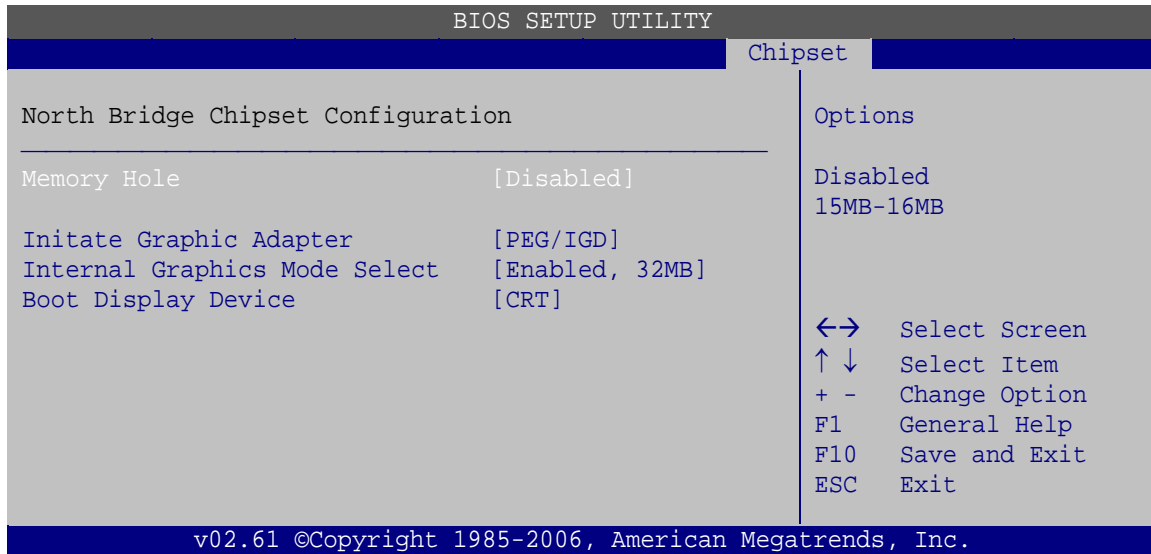


### **BIOS Menu 17: Chipset**

#### 5.7.1 North Bridge Chipset Configuration

Use the **North Bridge Chipset Configuration** menu (**BIOS Menu 18**) to configure the Northbridge chipset settings.

## KINO-G410 Mini-ITX Motherboard



### BIOS Menu 18: North Bridge Chipset Configuration

#### ➔ Memory Hole [Disabled]

The **Memory Hole** reserves the memory space between 15MB and 16MB for ISA expansion cards that require a specified area of memory to work properly. If an older ISA expansion card is used, please refer to the documentation that came with the card to see if it is necessary to reserve the space.

- ➔ **Disabled**      **DEFAULT**      Memory is not reserved for ISA expansion cards
- ➔ **15MB-16MB**                      Memory is reserved for ISA expansion cards

#### ➔ Initate Graphic Adapter [PEG/IGD]

Use the **Initate Graphic Adapter** option to select the graphics controller used as the primary boot device.

- ➔ **IGD**                                      Select an integrated graphics controller (IGD)
- ➔ **PEG/IGD**      **DEFAULT**      Select a PCI express (PEG) controller or an IGD

#### ➔ Internal Graphics Mode Select [Enabled, 32MB]

The **Internal Graphic Mode Select** option determines the amount of system memory that can be used by the internal graphics device.

- ➔ **Disabled**
- ➔ **Enabled, 32MB**      **DEFAULT**      32MB of memory used by internal graphics device
- ➔ **Enabled, 64MB**                      64MB of memory used by internal graphics device
- ➔ **Enabled, 128MB**                      128MB of memory used by internal graphics device

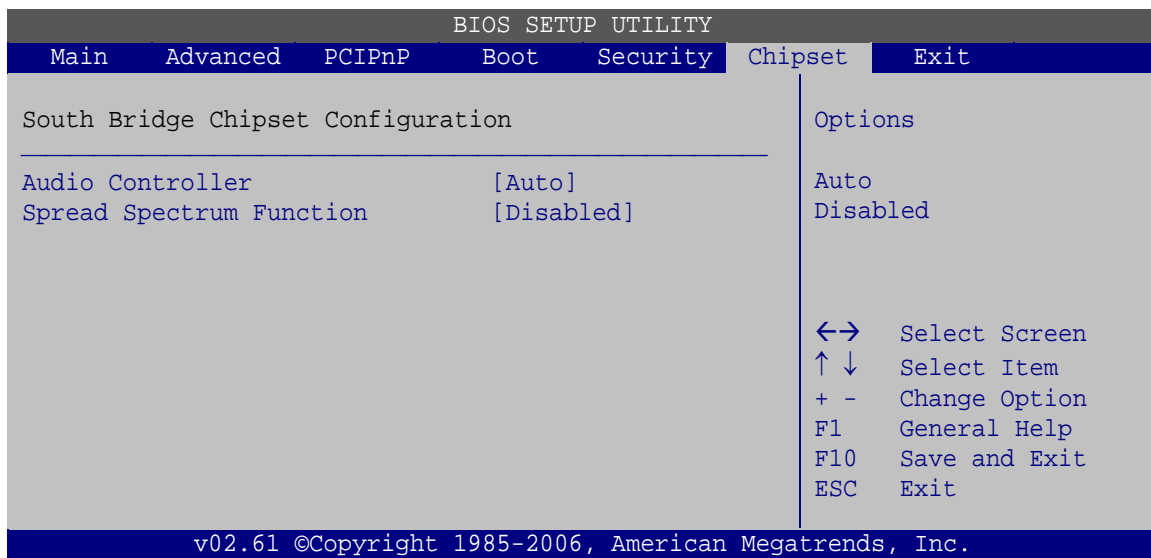
➔ **Boot Display Device [Auto]**

The **Boot Display Device** BIOS option selects the display device the system uses when it boots. The available options are listed below:

- **CRT**                      **DEFAULT**
- **CRT+LVDS**

### 5.7.2 South Bridge Chipset Configuration

The **South Bridge Chipset Configuration** menu (**BIOS Menu 19**) allows the southbridge chipset to be configured.



#### **BIOS Menu 19: South Bridge Chipset Configuration**

➔ **Audio Controller [Auto]**

The **Audio Controller** option enables or disables the audio controller.



## KINO-G410 Mini-ITX Motherboard

- ➔ **Auto**                      **DEFAULT**      The on-board audio controller is detected and automatically enabled.
- ➔ **Disabled**                                      The on-board audio controller is disabled.

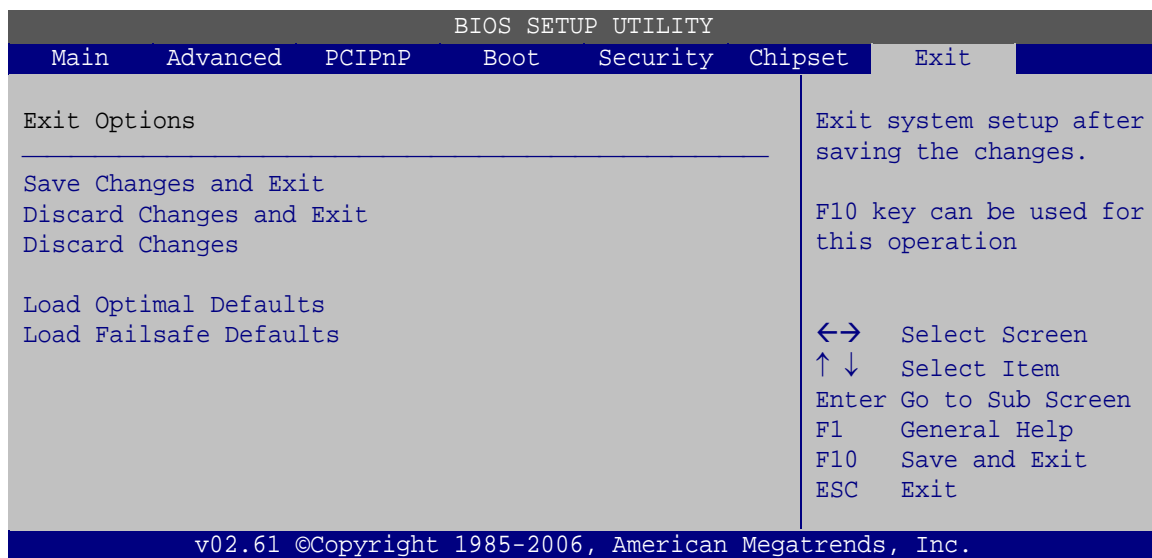
### ➔ Spread Spectrum Function [Disabled]

Use the **Spread Spectrum Function** option to reduce the EMI. Excess EMI is generated when the system clock generator pulses have extreme values. Spreading the pulse spectrum modulates changes in the extreme values from spikes to flat curves, thus reducing the EMI. This benefit may in some cases be outweighed by problems with timing-critical devices, such as a clock-sensitive SCSI device.

- ➔ **Disabled**      **DEFAULT**      EMI not reduced
- ➔ **Enabled**                                      EMI reduced

## 5.8 Exit

Use the **Exit** menu (**BIOS Menu 20**) to load default BIOS values, optimal failsafe values and to save configuration changes.



### BIOS Menu 20: Exit

- ➔ Save Changes and Exit

Use the **Save Changes and Exit** option to save the changes made to the BIOS options and to exit the BIOS configuration setup program.

→ Discard Changes and Exit

Use the **Discard Changes and Exit** option to exit the BIOS configuration setup program without saving the changes made to the system.

→ Discard Changes

Use the **Discard Changes** option to discard the changes and remain in the BIOS configuration setup program.

→ Load Optimal Defaults

Use the **Load Optimal Defaults** option to load the optimal default values for each of the parameters on the Setup menus. **F9 key can be used for this operation.**

→ Load Failsafe Defaults

Use the **Load Failsafe Defaults** option to load failsafe default values for each of the parameters on the Setup menus. **F8 key can be used for this operation.**

Appendix

A

# BIOS Options

---

Below is a list of BIOS configuration options in the BIOS chapter.

➔	<b>System Overview</b> .....	<b>59</b>
➔	<b>System Time [xx:xx:xx]</b> .....	<b>60</b>
➔	<b>System Date [xx/xx/xx]</b> .....	<b>60</b>
➔	<b>ATA/IDE Configuration [Enhanced]</b> .....	<b>62</b>
➔	<b>Configure SATA as [IDE]</b> .....	<b>62</b>
➔	<b>IDE Master and IDE Slave</b> .....	<b>62</b>
➔	<b>Auto-Detected Drive Parameters</b> .....	<b>63</b>
➔	<b>Type [Auto]</b> .....	<b>64</b>
➔	<b>LBA/Large Mode [Auto]</b> .....	<b>65</b>
➔	<b>Block (Multi Sector Transfer) [Auto]</b> .....	<b>65</b>
➔	<b>PIO Mode [Auto]</b> .....	<b>66</b>
➔	<b>DMA Mode [Auto]</b> .....	<b>66</b>
➔	<b>S.M.A.R.T [Auto]</b> .....	<b>67</b>
➔	<b>32Bit Data Transfer [Enabled]</b> .....	<b>67</b>
➔	<b>Serial Port1 Address [3F8]</b> .....	<b>68</b>
➔	<b>Serial Port1 IRQ [IRQ4]</b> .....	<b>68</b>
➔	<b>Serial Port2 Address [2F8]</b> .....	<b>69</b>
➔	<b>Serial Port2 IRQ [IRQ3]</b> .....	<b>69</b>
➔	<b>Serial Port3 Address [3E8]</b> .....	<b>69</b>
➔	<b>Serial Port3 IRQ [IRQ11]</b> .....	<b>69</b>
➔	<b>Serial Port4 Address [2E8]</b> .....	<b>70</b>
➔	<b>Serial Port4 IRQ [IRQ10]</b> .....	<b>70</b>
➔	<b>Serial Port5 Address [338]</b> .....	<b>70</b>
➔	<b>Serial Port5 IRQ [IRQ11]</b> .....	<b>70</b>
➔	<b>Serial Port6 Address [328]</b> .....	<b>70</b>
➔	<b>Serial Port6 IRQ [IRQ10]</b> .....	<b>71</b>
➔	<b>Select RS232 or RS422/RS485 [RS232]</b> .....	<b>71</b>
➔	<b>IR Function [COM6]</b> .....	<b>71</b>
➔	<b>Parallel Port Address [378]</b> .....	<b>71</b>
➔	<b>Parallel Port Mode [Normal]</b> .....	<b>71</b>
➔	<b>Parallel Port IRQ [IRQ7]</b> .....	<b>72</b>
➔	<b>CPU FAN1 Mode Setting [Auto Fan by RPM]</b> .....	<b>74</b>
➔	<b>CPU Temp. Limit of Highest / Second / Third / Lowest [n]</b> .....	<b>74</b>

## KINO-G410 Mini-ITX Motherboard

➔ CPU Fan1 Highest Setting [100] .....	74
➔ CPU Fan1 Second / Third / Fourth / Lowest Setting [n] .....	74
➔ SYS FAN1 Mode Setting [Auto Fan by RPM] .....	74
➔ SYS Temp. Limit of Highest / Second / Third / Lowest [n].....	75
➔ SYS Fan1 Highest Setting [100] .....	75
➔ SYS Fan1 Second / Third / Fourth / Lowest Setting [n] .....	75
➔ Monitored Values .....	75
➔ Select AT/ATX Power [ATX Power] .....	76
➔ Suspend mode [S1 (POS)] .....	77
➔ Restore on AC Power Loss [Last State].....	78
➔ Resume On RTC Alarm [Disabled].....	78
➔ Remote Access [Disabled].....	79
➔ Serial port number [COM1] .....	80
➔ Base Address, IRQ [3F8h,4].....	80
➔ Serial Port Mode [115200 8,n,1].....	80
➔ Redirection After BIOS POST [Always] .....	81
➔ Terminal Type [ANSI].....	81
➔ USB Functions [Enabled].....	82
➔ USB 2.0 Controller [Enabled].....	82
➔ Legacy USB Support [Enabled].....	82
➔ USB 2.0 Controller Mode [HiSpeed].....	83
➔ IRQ# [Available].....	84
➔ DMA Channel# [Available] .....	85
➔ Reserved Memory Size [Disabled] .....	85
➔ Quick Boot [Enabled] .....	87
➔ Quiet Boot [Enabled] .....	87
➔ AddOn ROM Display Mode [Force BIOS] .....	87
➔ Bootup Num-Lock [On] .....	87
➔ Boot From LAN Support [Disabled] .....	88
➔ Change Supervisor Password.....	88
➔ Change User Password.....	89
➔ Memory Hole [Disabled].....	91
➔ Initiate Graphic Adapter [PEG/IGD].....	91
➔ Internal Graphics Mode Select [Enabled, 32MB] .....	91
➔ Boot Display Device [Auto].....	92

➔	Audio Controller [Auto] .....	92
➔	Spread Spectrum Function [Disabled] .....	93
➔	Save Changes and Exit .....	93
➔	Discard Changes and Exit.....	94
➔	Discard Changes.....	94
➔	Load Optimal Defaults.....	94
➔	Load Failsafe Defaults.....	94

Appendix

B

# Terminology

---

AC '97	Audio Codec 97 (AC'97) refers to a codec standard developed by Intel® in 1997.
ACPI	Advanced Configuration and Power Interface (ACPI) is an OS-directed configuration, power management, and thermal management interface.
AHCI	Advanced Host Controller Interface (AHCI) is a SATA Host controller register-level interface.
ATA	The Advanced Technology Attachment (ATA) interface connects storage devices including hard disks and CD-ROM drives to a computer.
ARMD	An ATAPI Removable Media Device (ARMD) is any ATAPI device that supports removable media, besides CD and DVD drives.
ASKIR	Amplitude Shift Keyed Infrared (ASKIR) is a form of modulation that represents a digital signal by varying the amplitude (“volume”) of the signal. A low amplitude signal represents a binary 0, while a high amplitude signal represents a binary 1.
BIOS	The Basic Input/Output System (BIOS) is firmware that is first run when the computer is turned on and can be configured by the end user
CODEC	The Compressor-Decompressor (CODEC) encodes and decodes digital audio data on the system.
CMOS	Complimentary metal-oxide-conductor is an integrated circuit used in chips like static RAM and microprocessors.
COM	COM refers to serial ports. Serial ports offer serial communication to expansion devices. The serial port on a personal computer is usually a male DB-9 connector.
DAC	The Digital-to-Analog Converter (DAC) converts digital signals to analog signals.
DDR	Double Data Rate refers to a data bus transferring data on both the rising and falling edges of the clock signal.
DMA	Direct Memory Access (DMA) enables some peripheral devices to bypass the system processor and communicate directly with the system memory.



## KINO-G410 Mini-ITX Motherboard

DIMM	Dual Inline Memory Modules are a type of RAM that offer a 64-bit data bus and have separate electrical contacts on each side of the module.
DIO	The digital inputs and digital outputs are general control signals that control the on/off circuit of external devices or TTL devices. Data can be read or written to the selected address to enable the DIO functions.
EHCI	The Enhanced Host Controller Interface (EHCI) specification is a register-level interface description for USB 2.0 Host Controllers.
EIDE	Enhanced IDE (EIDE) is a newer IDE interface standard that has data transfer rates between 4.0 MBps and 16.6 MBps.
EIST	Enhanced Intel® SpeedStep Technology (EIST) allows users to modify the power consumption levels and processor performance through application software. The application software changes the bus-to-core frequency ratio and the processor core voltage.
FSB	The Front Side Bus (FSB) is the bi-directional communication channel between the processor and the Northbridge chipset.
GbE	Gigabit Ethernet (GbE) is an Ethernet version that transfers data at 1.0 Gbps and complies with the IEEE 802.3-2005 standard.
GPIO	General purpose input
HDD	Hard disk drive (HDD) is a type of magnetic, non-volatile computer storage device that stores digitally encoded data.
ICH	The Input/Output Control Hub (ICH) is an Intel® Southbridge chipset.
IrDA	Infrared Data Association (IrDA) specify infrared data transmission protocols used to enable electronic devices to wirelessly communicate with each other.
L1 Cache	The Level 1 Cache (L1 Cache) is a small memory cache built into the system processor.
L2 Cache	The Level 2 Cache (L2 Cache) is an external processor memory cache.
LCD	Liquid crystal display (LCD) is a flat, low-power display device that consists of two polarizing plates with a liquid crystal panel in between.

LVDS	Low-voltage differential signaling (LVDS) is a dual-wire, high-speed differential electrical signaling system commonly used to connect LCD displays to a computer.
POST	The Power-on Self Test (POST) is the pre-boot actions the system performs when the system is turned-on.
RAM	Random Access Memory (RAM) is volatile memory that loses data when power is lost. RAM has very fast data transfer rates compared to other storage like hard drives.
SATA	Serial ATA (SATA) is a serial communications bus designed for data transfers between storage devices and the computer chipsets. The SATA bus has transfer speeds up to 1.5 Gbps and the SATA II bus has data transfer speeds of up to 3.0 Gbps.
S.M.A.R.T	Self Monitoring Analysis and Reporting Technology (S.M.A.R.T) refers to automatic status checking technology implemented on hard disk drives.
UART	Universal Asynchronous Receiver-transmitter (UART) is responsible for asynchronous communications on the system and manages the system's serial communication (COM) ports.
UHCI	The Universal Host Controller Interface (UHCI) specification is a register-level interface description for USB 1.1 Host Controllers.
USB	The Universal Serial Bus (USB) is an external bus standard for interfacing devices. USB 1.1 supports 12Mbps data transfer rates and USB 2.0 supports 480Mbps data transfer rates.
VGA	The Video Graphics Array (VGA) is a graphics display system developed by IBM.

Appendix

C

# One Key Recovery

---

## C.1 One Key Recovery Introduction

The IEI one key recovery is an easy-to-use front end for the Norton Ghost system backup and recovery tool. The one key recovery provides quick and easy shortcuts for creating a backup and reverting to that backup or for reverting to the factory default settings.

The IEI One Key Recovery tool menu is shown below.

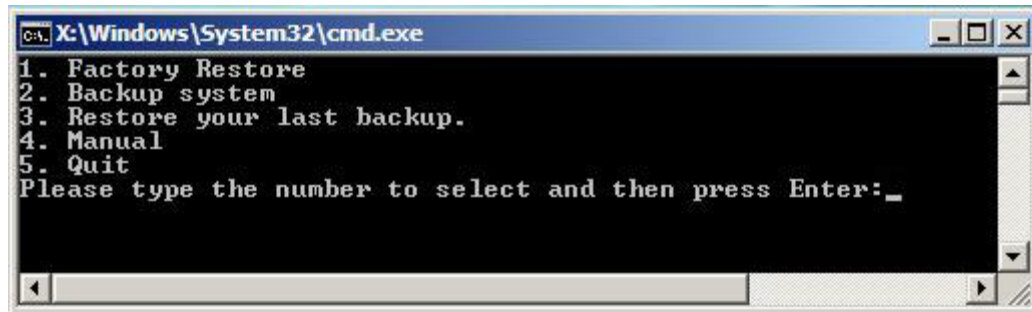


Figure C-1: IEI One Key Recovery Tool Menu

Prior to using the IEI One Key Recovery tool (as shown in **Figure C-1**) to backup or restore Windows system, five setup procedures are required.

1. Hardware and BIOS setup (see **Section C.2.1**)
2. Create partitions (see **Section C.2.2**)
3. Install operating system, drivers and system applications (see **Section C.2.3**)
4. Build-up recovery partition (see **Section C.2.4**)
5. Create factory default image (see **Section C.2.5**)

After completing the five initial setup procedures as described above, users can access the recovery tool by pressing <F3> while booting up the system. The detailed information of each function is described in **Section C.4**.



### NOTE:

The initial setup procedures for Linux system are described in **Section C.3**.

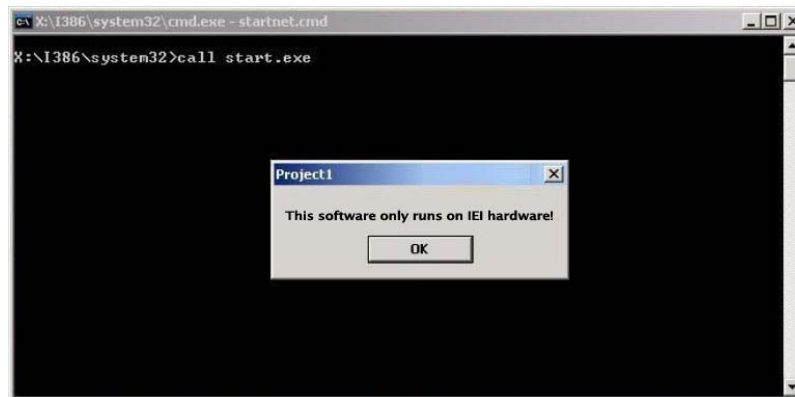
---

### C.1.1 System Requirement



**NOTE:**

The recovery CD can only be used with IEI products. The software will fail to run and a warning message will appear when used on non-IEI hardware.



To create the system backup, the main storage device must be split into two partitions (three partitions for Linux). The first partition will be for the operating system, while the second partition will be invisible to the operating system and contain the backup made by the one key recovery software.

The partition created for recovery images must be big enough to contain both the factory default image and the user backup image. The size must be calculated before creating the partitions. Please take the following table as a reference when calculating the size of the partition.

	OS	OS Image after Ghost	Compression Ratio
<b>Windows® 7</b>	7 GB	5 GB	70%
<b>Windows® XPE</b>	776 MB	560 MB	70%
<b>Windows® CE 6.0</b>	36 MB	28 MB	77%

**NOTE:**

Specialized tools are required to change the partition size if the operating system is already installed.

### C.1.2 Supported Operating System

The recovery CD is compatible with both Microsoft Windows and Linux operating system (OS). The supported OS versions are listed below.

- Microsoft Windows
  - Windows XP (Service Pack 2 or 3 required)
  - Windows Vista
  - Windows 7
  - Windows CE 5.0
  - Windows CE 6.0
  - Windows XP Embedded
- Linux
  - Fedora Core 12 (Constantine)
  - Fedora Core 11 (Leonidas)
  - Fedora Core 10 (Cambridge)
  - Fedora Core 8 (Werewolf)
  - Fedora Core 7 (Moonshine)
  - RedHat RHEL-5.4
  - RedHat 9 (Ghirke)
  - Ubuntu 8.10 (Intrepid)
  - Ubuntu 7.10 (Gutsy)
  - Ubuntu 6.10 (Edgy)
  - Debian 5.0 (Lenny)
  - Debian 4.0 (Etch)
  - SuSe 11.2
  - SuSe 10.3

**NOTE:**

Installing unsupported OS versions may cause the recovery tool to fail.

## C.2 Setup Procedure for Windows

Prior to using the recovery tool to backup or restore Windows system, a few setup procedures are required.

**Step 1:** Hardware and BIOS setup (see **Section C.2.1**)

**Step 2:** Create partitions (see **Section C.2.2**)

**Step 3:** Install operating system, drivers and system applications (see **Section C.2.3**)

**Step 4:** Build-up recovery partition (see **Section C.2.4**)

**Step 5:** Create factory default image (see **Section C.2.5**)

The detailed descriptions are described in the following sections.

**NOTE:**

The setup procedures described below are for Microsoft Windows operating system users. For Linux system, most setup procedures are the same with Microsoft Windows except for several steps described in **Section C.3**.

### C.2.1 Hardware and BIOS Setup

**Step 1:** Make sure the system is powered off and unplugged.

**Step 2:** Install a hard drive or SSD in the system. An unformatted and unpartitioned disk is recommended.

**Step 3:** Connect an optical disk drive to the system and insert the recovery CD.

- Step 4:** Turn on the system.
- Step 5:** Press the <DELETE> key as soon as the system is turned on to enter the BIOS.
- Step 6:** Select the connected optical disk drive as the 1<sup>st</sup> boot device. (**Boot → Boot Device Priority → 1<sup>st</sup> Boot Device**).
- Step 7:** Save changes and restart the computer. Continue to the next section for instructions on partitioning the internal storage.

### C.2.2 Create Partitions

To create the system backup, the main storage device must be split into two partitions (three partitions for Linux). The first partition will be for the operating system, while the second partition will be invisible to the operating system and contain the backup made by the one key recovery software.

- Step 1:** Put the recovery CD in the optical drive of the system.
- Step 2:** **Boot the system from recovery CD.** When prompted, press any key to boot from the recovery CD. It will take a while to launch the recovery tool. Please be patient!



**Figure C-2: Launching the Recovery Tool**



## KINO-G410 Mini-ITX Motherboard

Step 3: The recovery tool setup menu is shown as below.

```
C:\ X:\I386\system32\cmd.exe
1.Ghost Execution
2.System Configuration For Windows
3.System Configuration For Linux
4.Exit
5.CMD
Type the number to print text._
```

Figure C-3: Recovery Tool Setup Menu

Step 4: Press <5> then <Enter>.

```
C:\ X:\I386\system32\cmd.exe
1.Ghost Execution
2.System Configuration For Windows
3.System Configuration For Linux
4.Exit
5.CMD
Type the number to print text 5
```

Figure C-4: Command Mode

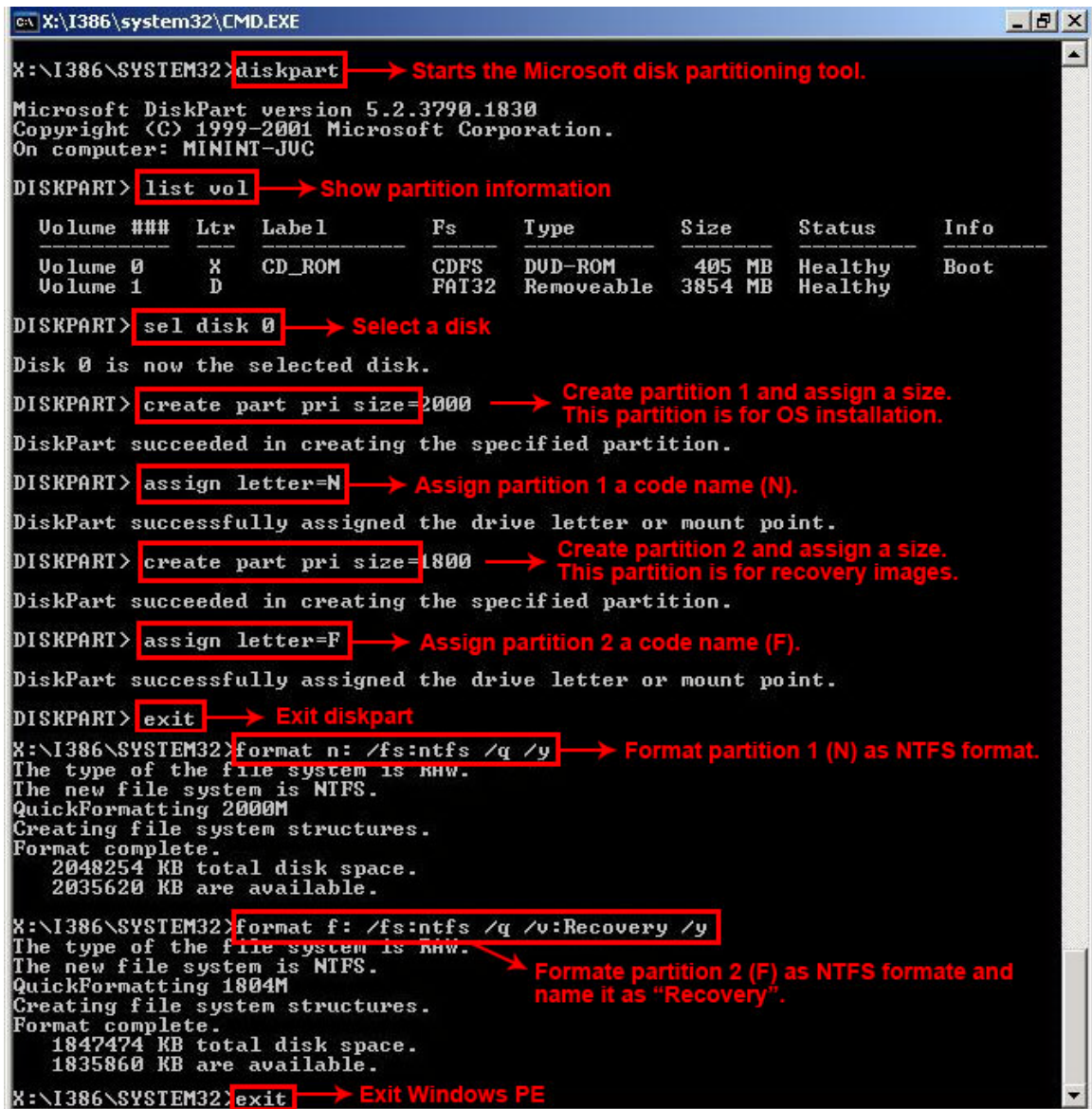
Step 5: The command prompt window appears. Type the following commands (marked in red) to create two partitions. One is for the OS installation; the other is for saving recovery files and images which will be an invisible partition.

(Press <Enter> after entering each line below)

```
system32>diskpart
DISKPART>list vol
DISKPART>sel disk 0
DISKPART>create part pri size= ____
DISKPART>assign letter=N
DISKPART>create part pri size= ____
DISKPART>assign letter=F
DISKPART>exit
system32>format N: /fs:ntfs /q /y
```

system32>format F: /fs:ntfs /q /v:Recovery /y

system32>exit



```
X:\I386\SYSTEM32\CMD.EXE
X:\I386\SYSTEM32>diskpart → Starts the Microsoft disk partitioning tool.
Microsoft DiskPart version 5.2.3790.1830
Copyright (C) 1999-2001 Microsoft Corporation.
On computer: MININT-JUC
DISKPART> list vol → Show partition information
Volume ### Ltr Label Fs Type Size Status Info
-----
Volume 0 X CD_ROM GDFS DVD-ROM 405 MB Healthy Boot
Volume 1 D FAT32 Removeable 3854 MB Healthy
DISKPART> sel disk 0 → Select a disk
Disk 0 is now the selected disk.
DISKPART> create part pri size=2000 → Create partition 1 and assign a size.
This partition is for OS installation.
DiskPart succeeded in creating the specified partition.
DISKPART> assign letter=N → Assign partition 1 a code name (N).
DiskPart successfully assigned the drive letter or mount point.
DISKPART> create part pri size=1800 → Create partition 2 and assign a size.
This partition is for recovery images.
DiskPart succeeded in creating the specified partition.
DISKPART> assign letter=F → Assign partition 2 a code name (F).
DiskPart successfully assigned the drive letter or mount point.
DISKPART> exit → Exit diskpart
X:\I386\SYSTEM32>format n: /fs:ntfs /q /y → Format partition 1 (N) as NTFS format.
The type of the file system is RAW.
The new file system is NTFS.
QuickFormatting 2000M
Creating file system structures.
Format complete.
2048254 KB total disk space.
2035620 KB are available.
X:\I386\SYSTEM32>format f: /fs:ntfs /q /v:Recovery /y → Formate partition 2 (F) as NTFS formate and
name it as "Recovery".
The type of the file system is RAW.
The new file system is NTFS.
QuickFormatting 1804M
Creating file system structures.
Format complete.
1847474 KB total disk space.
1835860 KB are available.
X:\I386\SYSTEM32>exit → Exit Windows PE
```

Figure C-5: Partition Creation Commands

**NOTE:**

Use the following commands to check if the partitions were created successfully.

```
X:\I386\SYSTEM32>diskpart
Microsoft DiskPart version 5.2.3790.1830
Copyright (C) 1999-2001 Microsoft Corporation.
On computer: MININT-JUC

DISKPART> sel disk 0
Disk 0 is now the selected disk.

DISKPART> list part

   Partition ###   Type              Size              Offset
-----
Partition 1       Primary           2000 MB           32 KB
Partition 2       Primary           1804 MB           2000 MB

DISKPART> exit
```

**Step 6:** Press any key to exit the recovery tool and automatically reboot the system.

Please continue to the following procedure: Build-up Recovery Partition.

### C.2.3 Install Operating System, Drivers and Applications

Install the operating system onto the unlabelled partition. The partition labeled as "Recovery" is for use by the system recovery tool and should not be used for installing the operating system or any applications.

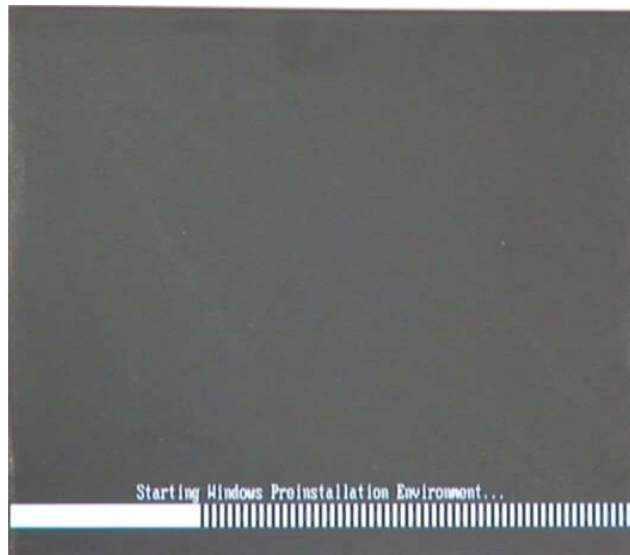
**NOTE:**

The operating system installation program may offer to reformat the chosen partition. DO NOT format the partition again. The partition has already been formatted and is ready for installing the new operating system.

To install the operating system, insert the operating system installation CD into the optical drive. Restart the computer and follow the installation instructions.

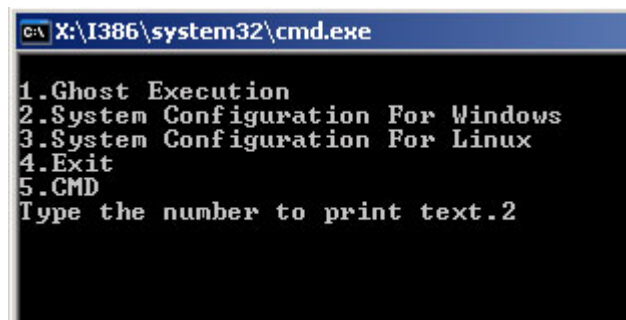
## C.2.4 Build-up Recovery Partition

- Step 1:** Put the recover CD in the optical drive.
- Step 2:** Start the system.
- Step 3:** **Boot the system from recovery CD.** When prompted, press any key to boot from the recovery CD. It will take a while to launch the recovery tool. Please be patient!



**Figure C-6: Launching the Recovery Tool**

- Step 4:** When the recovery tool setup menu appears, press <2> then <Enter>.

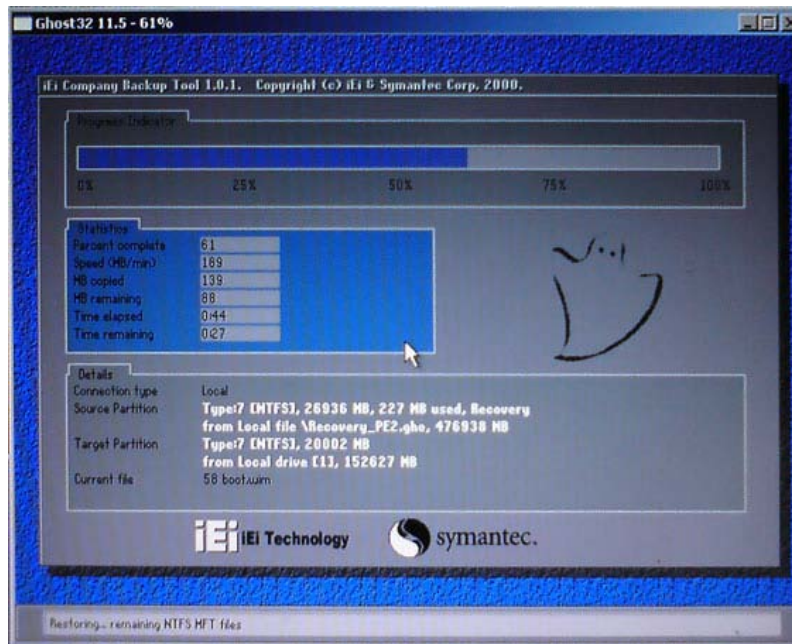


**Figure C-7: System Configuration for Windows**

- Step 5:** The Symantec Ghost window appears and starts configuring the system to build-up a recovery partition. In this process, the partition which is created for

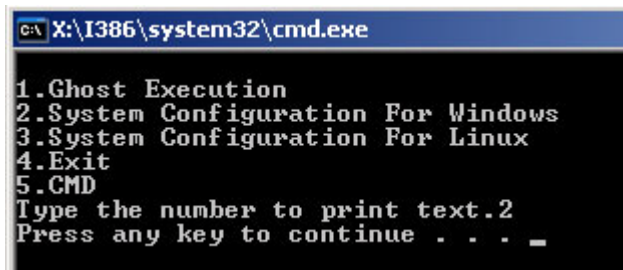
## KINO-G410 Mini-ITX Motherboard

recovery files in **Section C.2.2** is hidden and the recovery tool is saved in this partition.



**Figure C-8: Build-up Recovery Partition**

**Step 6:** After completing the system configuration, press any key in the following window to reboot the system.



**Figure C-9: Press any key to continue**

**Step 7:** Eject the recovery CD.

### C.2.5 Create Factory Default Image

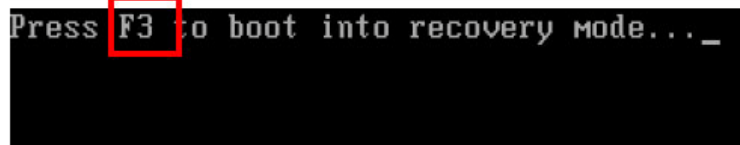


#### NOTE:

Before creating the factory default image, please configure the system to a factory default environment, including driver and application installations.

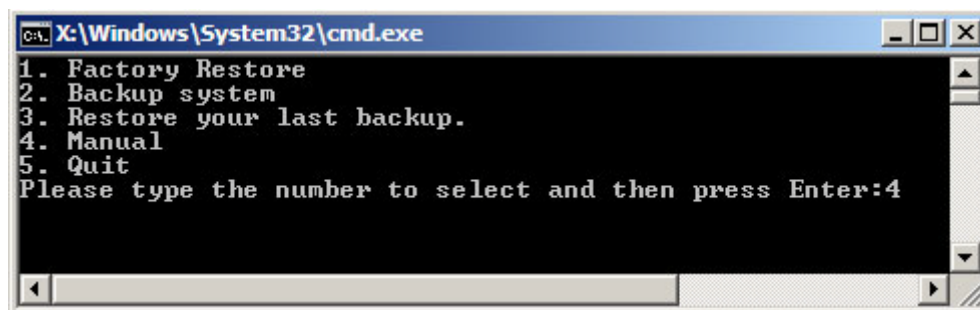
To create a factory default image, please follow the steps below.

**Step 1:** Turn on the system. When the following screen displays (**Figure C-10**), press the <F3> key to access the recovery tool. The message will display for 10 seconds, please press F3 before the system boots into the operating system.



**Figure C-10: Press F3 to Boot into Recovery Mode**

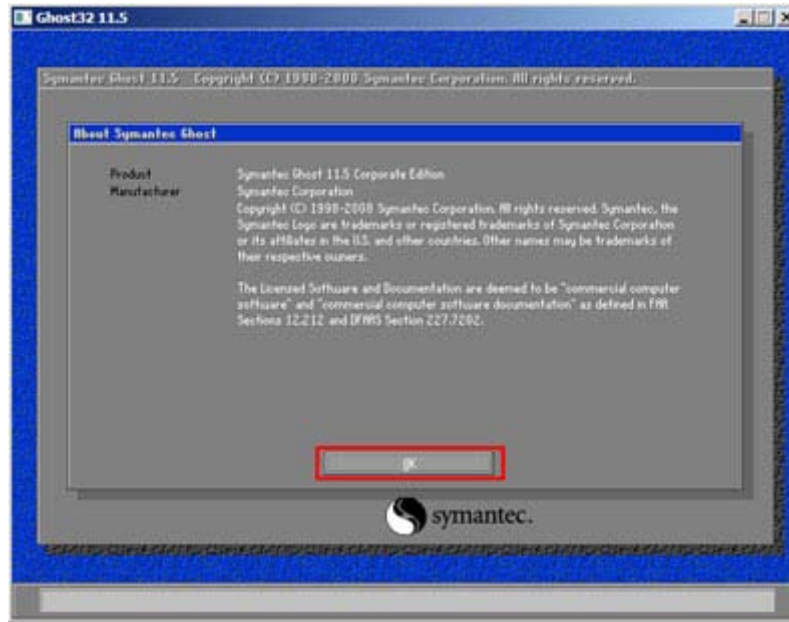
**Step 2:** The recovery tool menu appears. Type <4> and press <Enter>. (**Figure C-11**)



**Figure C-11: Recovery Tool Menu**

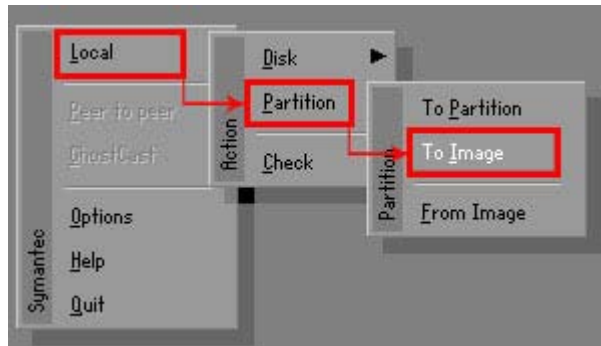
**Step 3:** The About Symantec Ghost window appears. Click **OK** button to continue.

## KINO-G410 Mini-ITX Motherboard



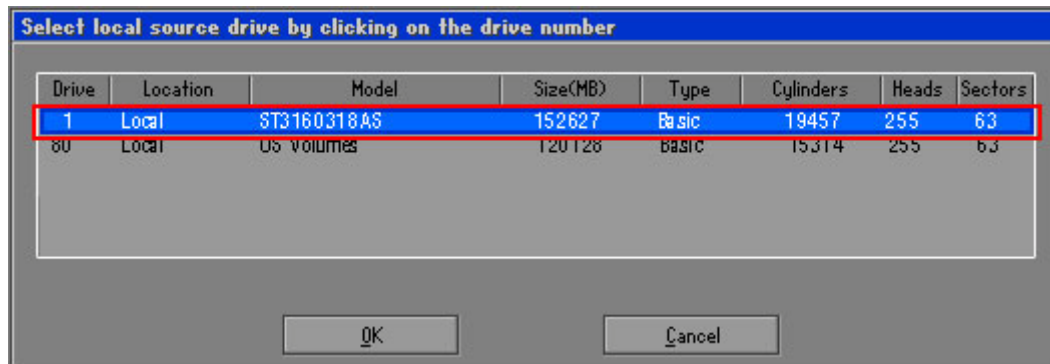
**Figure C-12: About Symantec Ghost Window**

**Step 4:** Use mouse to navigate to the option shown below (**Figure C-13**).

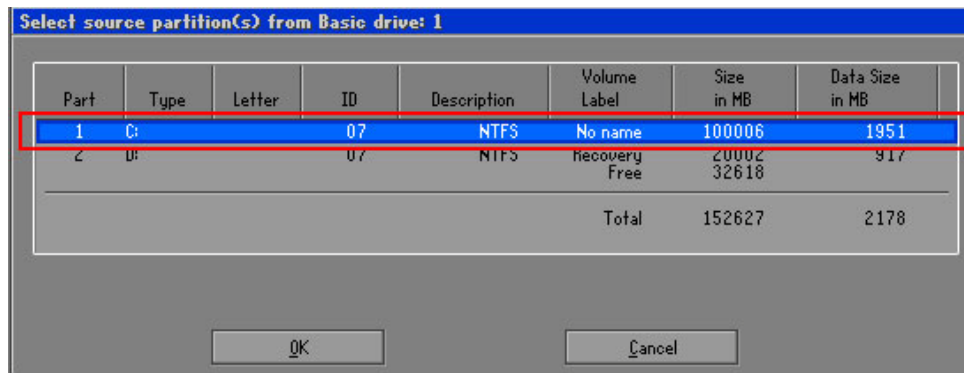


**Figure C-13: Symantec Ghost Path**

**Step 5:** Select the local source drive (Drive 1) as shown in **Figure C-14**. Then click OK.


**Figure C-14: Select a Local Source Drive**

**Step 6:** Select a source partition (Part 1) from basic drive as shown in **Figure C-15**. Then click OK.


**Figure C-15: Select a Source Partition from Basic Drive**

**Step 7:** Select **1.2: [Recovery] NTFS drive** and enter a file name called **iei** (**Figure C-16**). Click **Save**. The factory default image will then be saved in the selected recovery drive and named **IEI.GHO**.


**WARNING:**

The file name of the factory default image must be **iei.GHO**.



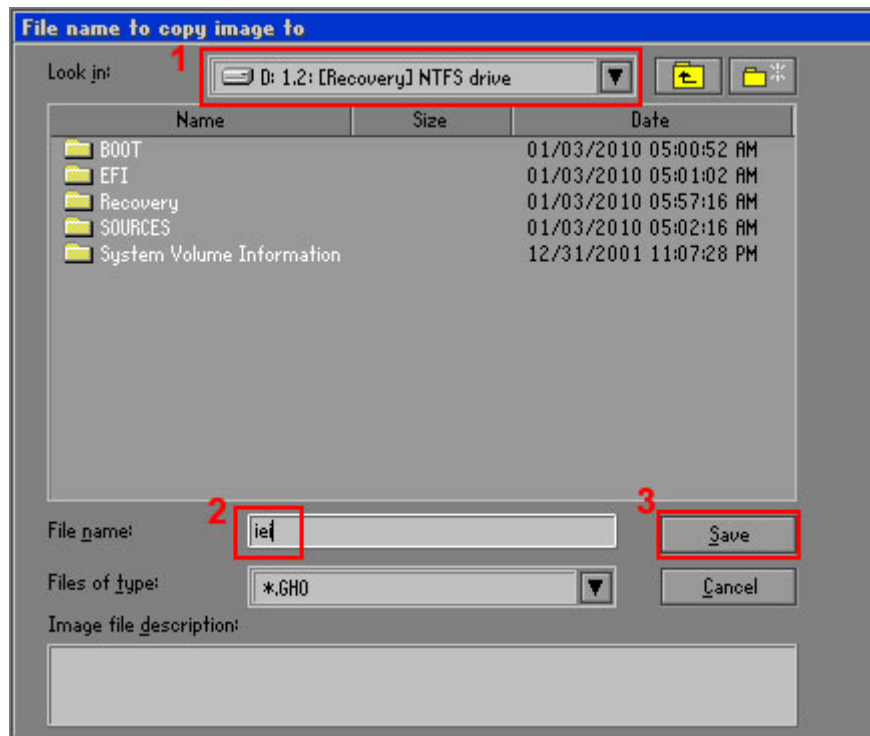


Figure C-16: File Name to Copy Image to

**Step 8:** When the Compress Image screen in **Figure C-17** prompts, click **High** to make the image file smaller.

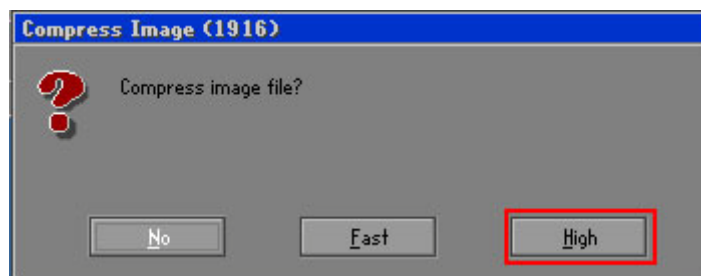
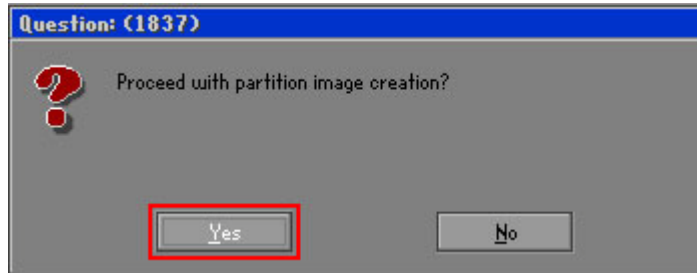


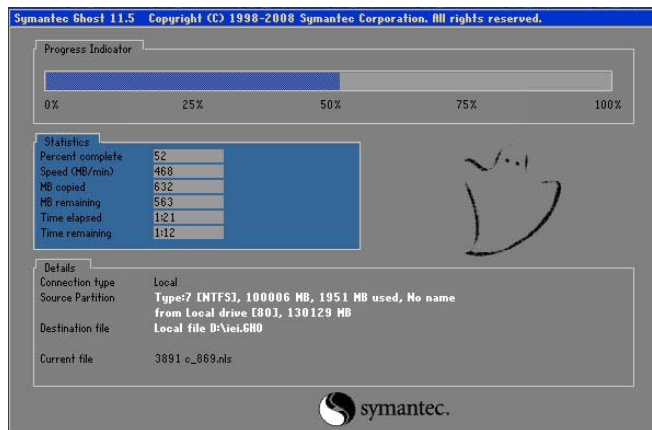
Figure C-17: Compress Image

**Step 9:** The Proceed with partition image creation window appears, click **Yes** to continue.



**Figure C-18: Image Creation Confirmation**

**Step 10:** The Symantec Ghost starts to create the factory default image (**Figure C-19**).



**Figure C-19: Image Creation Process**

**Step 11:** When the image creation completes, a screen prompts as shown in **Figure C-20**.

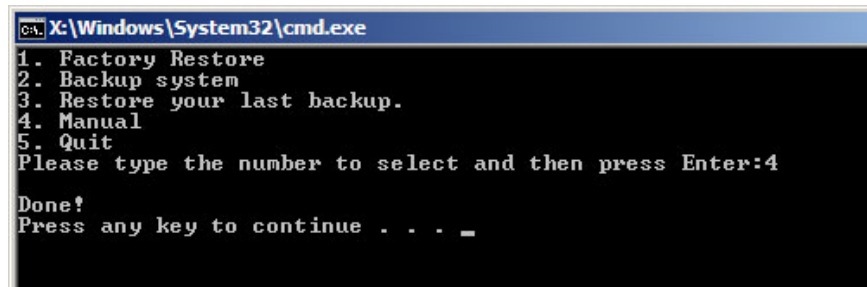
Click **Continue** and close the Ghost window to exit the program.



**Figure C-20: Image Creation Complete**

## KINO-G410 Mini-ITX Motherboard

**Step 12:** The recovery tool main menu window is shown as below. Press any key to reboot the system.



```
C:\Windows\System32\cmd.exe
1. Factory Restore
2. Backup system
3. Restore your last backup.
4. Manual
5. Quit
Please type the number to select and then press Enter:4
Done!
Press any key to continue . . . _
```

Figure C-21: Press Any Key to Continue

### C.3 Setup Procedure for Linux

The initial setup procedures for a Linux system are mostly the same with the procedure for Microsoft Windows. Please follow the steps below to setup the recovery tool for Linux OS.

**Step 1:** **Hardware and BIOS setup.** Refer to **Section C.2.1.**

**Step 2:** **Install Linux operating system.** Make sure to install GRUB (v0.97 or earlier) MBR type and Ext3 partition type. Leave enough space on the hard drive to create the recover partition later.

**NOTE:**

If the Linux OS is not installed with GRUB (v0.97 or earlier) and Ext3, the Symantec Ghost may not function properly.

---

While installing Linux OS, please create two partitions:

- Partition 1: /
- Partition 2: **SWAP**


**NOTE:**

Please reserve enough space for partition 3 for saving recovery images.

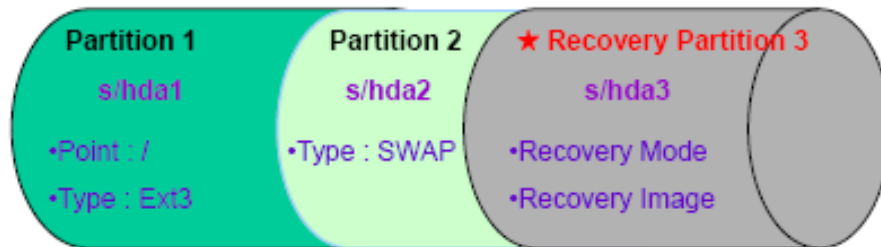


Figure C-22: Partitions for Linux

**Step 3:** Create a recovery partition. Insert the recovery CD into the optical disk drive.

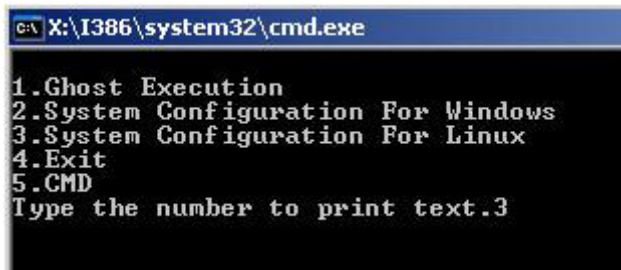
Follow **Step 1 ~ Step 3** described in **Section C.2.2**. Then type the following commands (marked in red) to create a partition for recovery images.

```

system32>diskpart
DISKPART>list vol
DISKPART>sel disk 0
DISKPART>create part pri size= ____
DISKPART>assign letter=N
DISKPART>exit
system32>format N: /fs:ntfs /q /v:Recovery /y
system32>exit
  
```

**Step 4:** Build-up recovery partition. Press any key to boot from the recovery CD. It will take a while to launch the recovery tool. Please be patient. When the recovery tool setup menu appears, type <3> and press <Enter> (**Figure C-23**). The Symantec Ghost window appears and starts configuring the system to build-up a recovery partition. After completing the system configuration, press any key to reboot the system. Eject the recovery CD.

## KINO-G410 Mini-ITX Motherboard



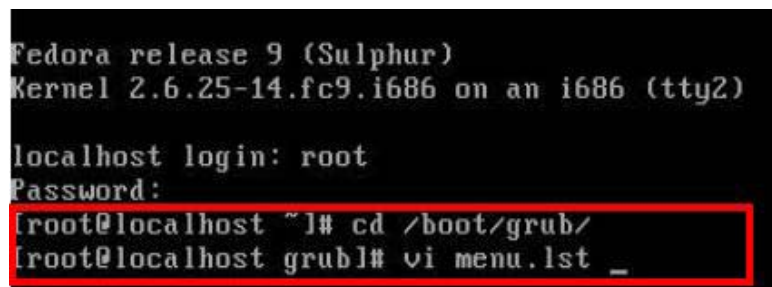
```
C:\X:\I386\system32\cmd.exe
1.Ghost Execution
2.System Configuration For Windows
3.System Configuration For Linux
4.Exit
5.CMD
Type the number to print text.3
```

Figure C-23: System Configuration for Linux

**Step 5:** Access the recovery tool main menu by modifying the “menu.lst”. To first access the recovery tool main menu, the menu.lst must be modified. In Linux system, enter Administrator (root). When prompt appears, type:

```
cd /boot/grub
```

```
vi menu.lst
```



```
Fedora release 9 (Sulphur)
Kernel 2.6.25-14.fc9.i686 on an i686 (tty2)

localhost login: root
Password:
[root@localhost ~]# cd /boot/grub/
[root@localhost grub]# vi menu.lst _
```

Figure C-24: Access menu.lst in Linux (Text Mode)

**Step 6:** Modify the menu.lst as shown below.

```
#boot=/dev/sda
default=0
timeout=10 ← Modify timeout=10
splashimage=(hd0,0)/grub/splash.xpm.gz
hiddenmenu
title Fedora (2.6.25-14.fc9.i686)
    root (hd0,0)
    kernel /vmlinuz-2.6.25-14.fc9.i686 ro root=UUID=10f1acd
    ac38b5c78910 rhgb quiet
    initrd /initrd-2.6.25-14.fc9.i686.img

title Recovery Partition
root (hd0,2)
makeactive ← Type command
chainloader +1
```

- **Type command:**  
**title Recovery Partition**  
**root (hd0,2)**  
**makeactive**  
**chainloader +1**

**Step 7:** The recovery tool menu appears. (Figure C-25)

```
1. Factory Restore
2. Backup system
3. Restore your last backup.
4. Manual
5. Quit
Please type the number to select and then press Enter:
```

**Figure C-25: Recovery Tool Menu**

**Step 8:** Create a factory default image. Follow **Step 2 ~ Step 12** described in **Section C.2.5** to create a factory default image.

## C.4 Recovery Tool Functions

After completing the initial setup procedures as described above, users can access the recovery tool by pressing **<F3>** while booting up the system. The main menu of the recovery tool is shown below.

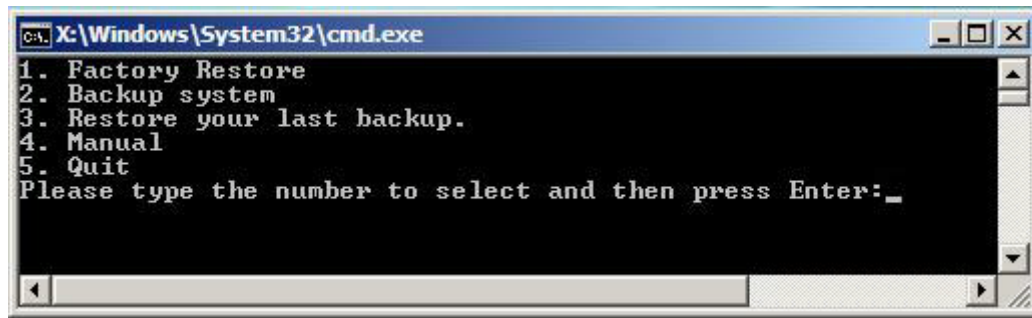


Figure C-26: Recovery Tool Main Menu

The recovery tool has several functions including:

1. **Factory Restore:** Restore the factory default image (iei.GHO) created in Section C.2.5.
2. **Backup system:** Create a system backup image (iei\_user.GHO) which will be saved in the hidden partition.
3. **Restore your last backup:** Restore the last system backup image
4. **Manual:** Enter the Symantec Ghost window to configure manually.
5. **Quit:** Exit the recovery tool and restart the system.



**WARNING:**

Please do not turn off the system power during the process of system recovery or backup.



**WARNING:**

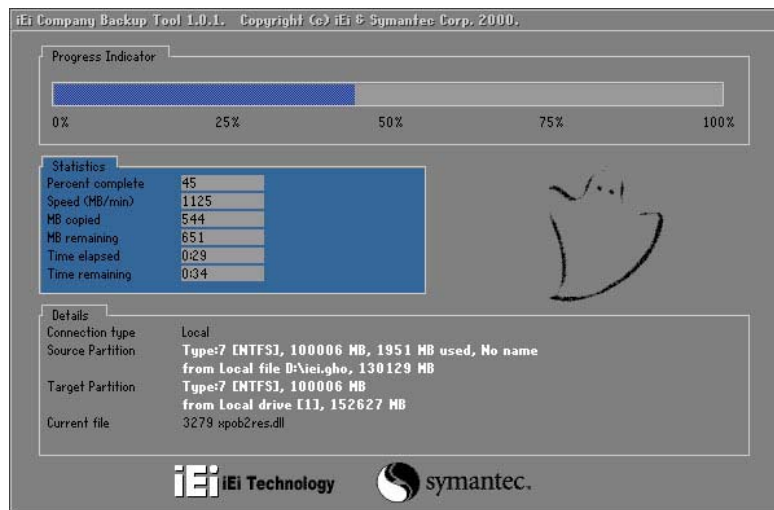
All data in the system will be deleted during the system recovery. Please backup the system files before restoring the system (either Factory Restore or Restore Backup).

### C.4.1 Factory Restore

To restore the factory default image, please follow the steps below.

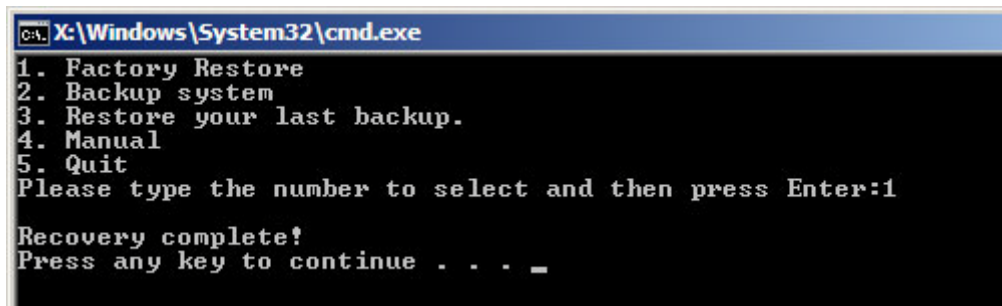
**Step 1:** Type <1> and press <Enter> in the main menu.

**Step 2:** The Symantec Ghost window appears and starts to restore the factory default. A factory default image called **iei.GHO** is created in the hidden Recovery partition.



**Figure C-27: Restore Factory Default**

**Step 3:** The screen is shown as in **Figure C-28** when completed. Press any key to reboot the system.



**Figure C-28: Recovery Complete Window**



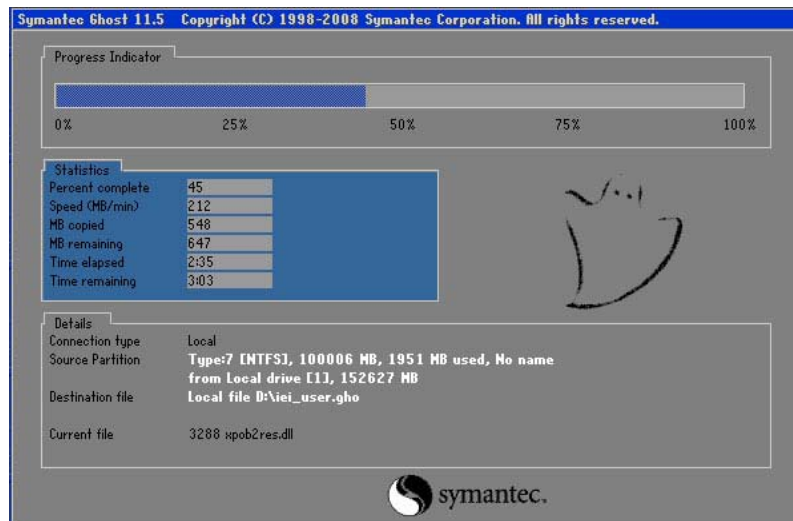
## KINO-G410 Mini-ITX Motherboard

### C.4.2 Backup System

To backup the system, please follow the steps below.

**Step 1:** Type <2> and press <Enter> in the main menu.

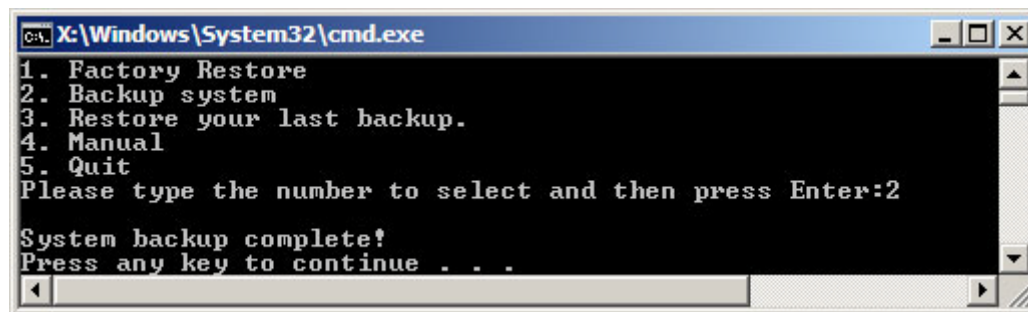
**Step 2:** The Symantec Ghost window appears and starts to backup the system. A backup image called `iei_user.GHO` is created in the hidden Recovery partition.



**Figure C-29: Backup System**

**Step 3:** The screen is shown as in **Figure C-30** when system backup is completed.

Press any key to reboot the system.



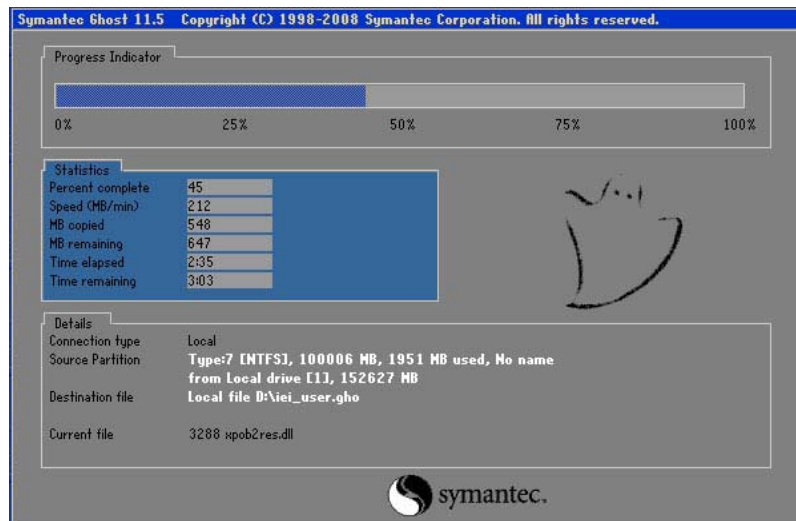
**Figure C-30: System Backup Complete Window**

### C.4.3 Restore Your Last Backup

To restore the last system backup, please follow the steps below.

**Step 1:** Type <3> and press <Enter> in the main menu.

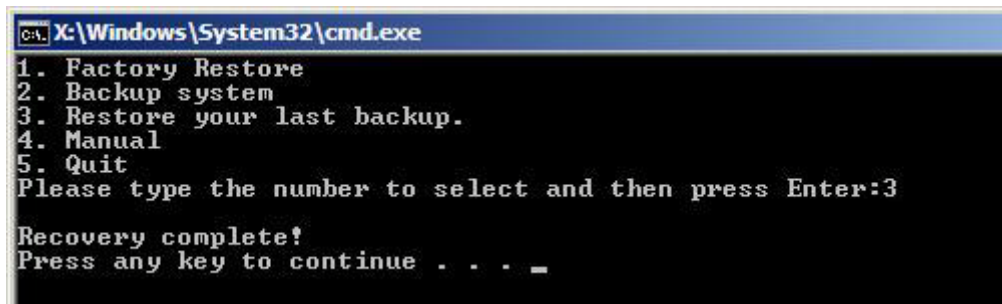
**Step 2:** The Symantec Ghost window appears and starts to restore the last backup image (iei\_user.GHO).



**Figure C-31: Restore Backup**

**Step 3:** The screen is shown as in **Figure C-32** when backup recovery is completed.

Press any key to reboot the system.



**Figure C-32: Restore System Backup Complete Window**

## KINO-G410 Mini-ITX Motherboard

## C.4.4 Manual

To restore the last system backup, please follow the steps below.

**Step 1:** Type <4> and press <Enter> in the main menu.

**Step 2:** The Symantec Ghost window appears. Use the Ghost program to backup or recover the system manually.

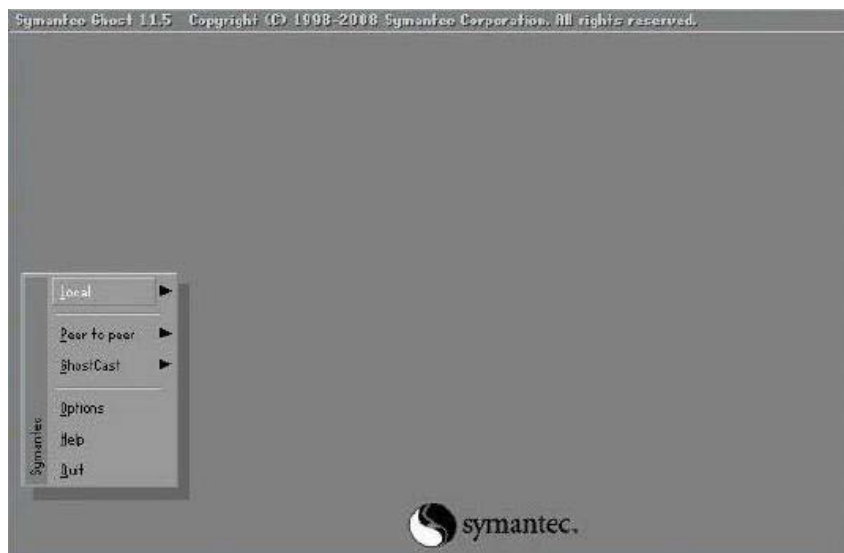


Figure C-33: Symantec Ghost Window

**Step 3:** When backup or recovery is completed, press any key to reboot the system.

## C.5 Other Information

### C.5.1 Using AHCI Mode or ALi M5283 / VIA VT6421A Controller

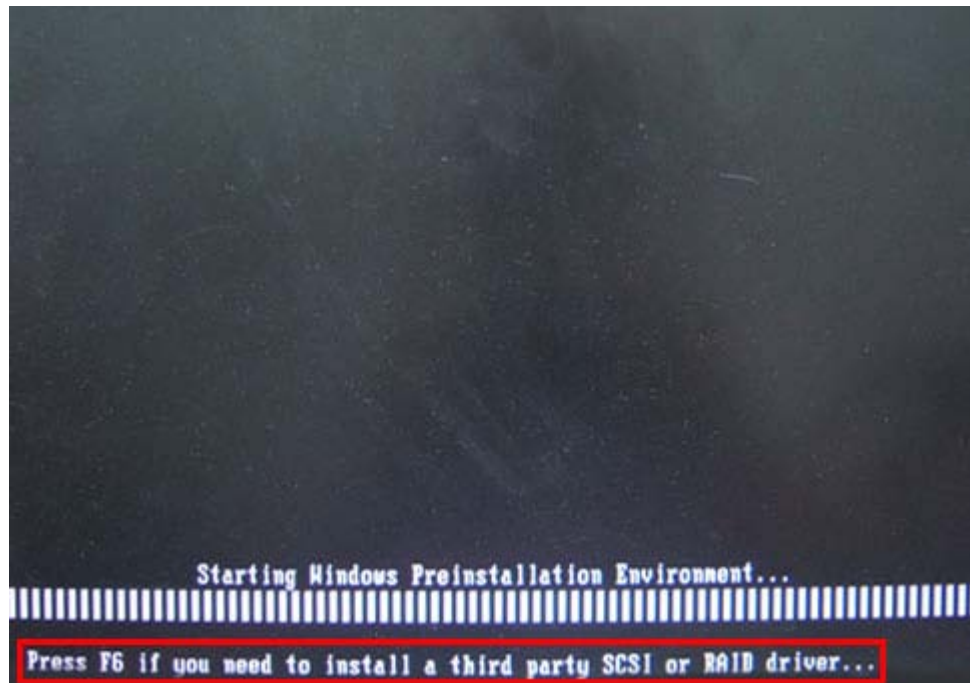
When the system uses AHCI mode or some specific SATA controllers such as ALi M5283 or VIA VT6421A, the SATA RAID/AHCI driver must be installed before using one key recovery. Please follow the steps below to install the SATA RAID/AHCI driver.

**Step 1:** Copy the SATA RAID/AHCI driver to a floppy disk and insert the floppy disk into a USB floppy disk drive. The SATA RAID/AHCI driver must be especially designed for the on-board SATA controller.

**Step 2:** Connect the USB floppy disk drive to the system.

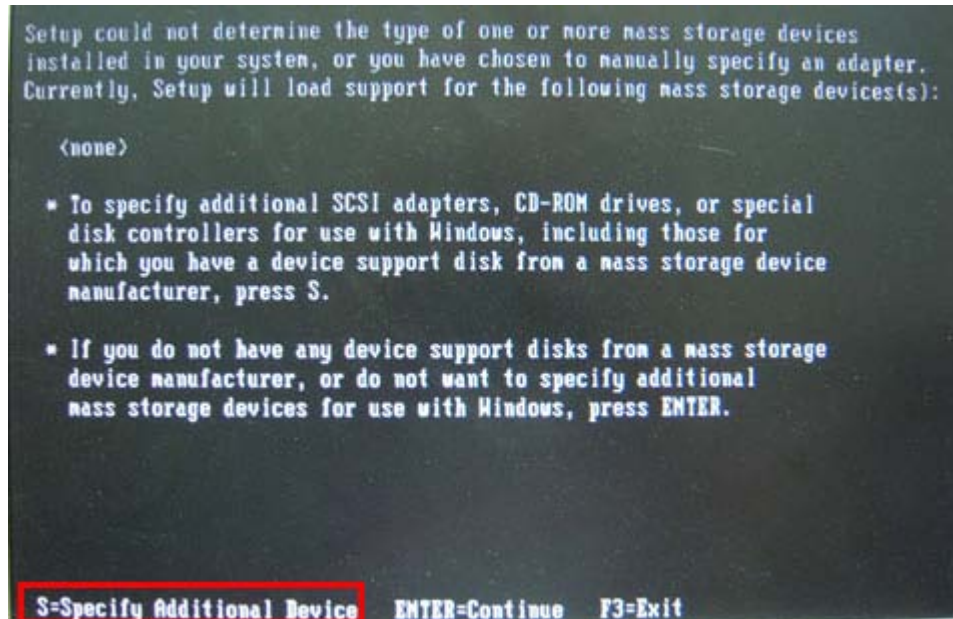
**Step 3:** Insert the One Key Recovery CD into the system and boot the system from the CD.

**Step 4:** When launching the recovery tool, press <F6>.

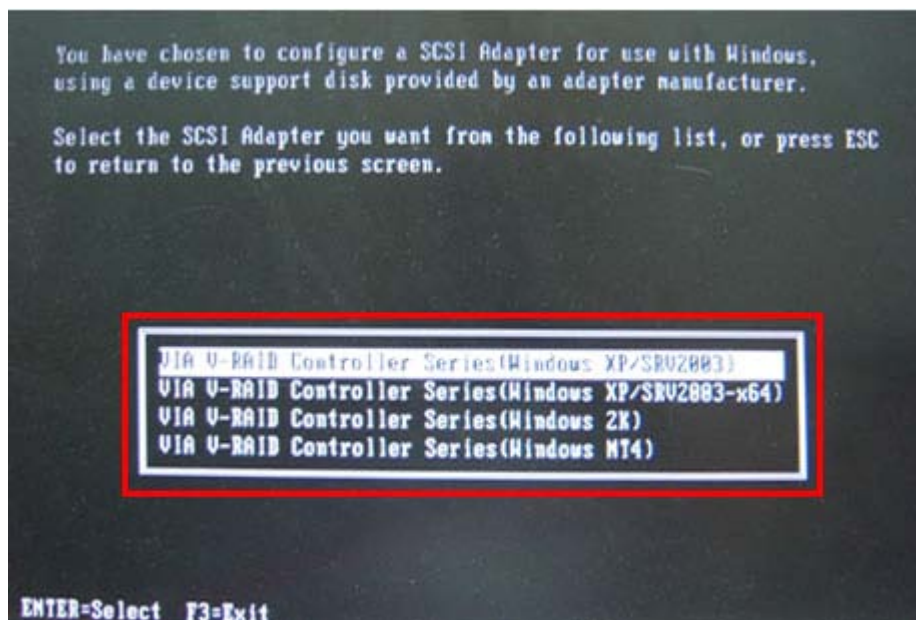


## KINO-G410 Mini-ITX Motherboard

**Step 5:** When the following window appears, press <S> to select “Specify Additional Device”.



**Step 6:** In the following window, select a SATA controller mode used in the system. Then press <Enter>. The user can now start using the SATA HDD.



**Step 7:** After pressing <Enter>, the system will get into the recovery tool setup menu. Continue to follow the setup procedure from **Step 4** in **Section C.2.2 Create Partitions** to finish the whole setup process.

### C.5.2 System Memory Requirement

To be able to access the recovery tool by pressing <F3> while booting up the system, please make sure to have enough system memory. The minimum memory requirement is listed below.

- **Using Award BIOS:** 128 MB system memory
- **Using AMI BIOS:** 512 MB system memory.

Appendix

D

# Watchdog Timer

---


**NOTE:**

The following discussion applies to DOS. Contact IEI support or visit the IEI website for drivers for other operating systems.

The Watchdog Timer is a hardware-based timer that attempts to restart the system when it stops working. The system may stop working because of external EMI or software bugs. The Watchdog Timer ensures that standalone systems like ATMs will automatically attempt to restart in the case of system problems.

A BIOS function call (INT 15H) is used to control the Watchdog Timer.

INT 15H:

AH – 6FH Sub-function:	
AL – 2:	Sets the Watchdog Timer's period.
BL:	Time-out value (Its unit-second is dependent on the item "Watchdog Timer unit select" in CMOS setup).

**Table D-1: AH-6FH Sub-function**

Call sub-function 2 to set the time-out period of Watchdog Timer first. If the time-out value is not zero, the Watchdog Timer starts counting down. When the timer value reaches zero, the system resets. To ensure that this reset condition does not occur, calling sub-function 2 must periodically refresh the Watchdog Timer. However, the watchdog timer is disabled if the time-out value is set to zero.

A tolerance of at least 10% must be maintained to avoid unknown routines within the operating system (DOS), such as disk I/O that can be very time-consuming.



**NOTE:**

The Watchdog Timer is activated through software. The software application that activates the Watchdog Timer must also deactivate it when closed. If the Watchdog Timer is not deactivated, the system will automatically restart after the Timer has finished its countdown.

**EXAMPLE PROGRAM:****; INITIAL TIMER PERIOD COUNTER**

;

**W\_LOOP:**

;

```
MOV    AX, 6F02H    ;setting the time-out value
MOV    BL, 30       ;time-out value is 48 seconds
INT    15H
```

;

**; ADD THE APPLICATION PROGRAM HERE**

;

```
CMP    EXIT_AP, 1   ;is the application over?
JNE    W_LOOP       ;No, restart the application
MOV    AX, 6F02H    ;disable Watchdog Timer
MOV    BL, 0        ;
INT    15H
```

;

**; EXIT ;**

Appendix

E

# Digital I/O Interface

---

## KINO-G410 Mini-ITX Motherboard

### E.1 Introduction

The digital I/O is used for machine control and automation.

### E.2 DIO Connector Pinouts

Located in the Connectors section of this document.

### E.3 Assembly Language Example

```

;*****
; DIO Port:  0A21h[3:0] (4 Out)
;            0A22h[3:0] (4 In)
;*****

;=====
; Get current input and output values into AL register
; AL: bit0~bit3 as output value
;     bit4~bit7 as Input value
;=====

        mov     dx, 0A21h      ; GPIO output I/O base address
        in      al, dx         ; Get output status
        jmp     $+2            ; Wait
        jmp     $+2            ; Wait
        and     al, 0Fh
        mov     bl, al         ; Move al to bl temporarily

        inc     dx             ; sets dx to 0A22h
        in      al, dx         ; Get input status
        jmp     $+2            ; Wait
        jmp     $+2            ; Wait
        and     al, 0Fh
        rol     al, 4           ; Shift input values over
        or      al, bl         ; Merge all results into AL
                                ; AL: bit0~bit3 as output value
                                ;     bit4~bit7 as input value

;=====
; Output value (x) to GPIO
; AL: bit0~bit3 as output value
;=====

        mov     al, 0xh        ; x is the output value (0 ~ Fh)
        mov     dx, 0A21h      ; GPIO output I/O base address
        out     dx, al         ; bit0 ~ bit3 as Output value
                                ; bit4 ~ bit7 are Reserved

```

Appendix

F

# Hazardous Materials Disclosure

---

## F.1 Hazardous Materials Disclosure Table for IPB Products Certified as RoHS Compliant Under 2002/95/EC Without Mercury

The details provided in this appendix are to ensure that the product is compliant with the Peoples Republic of China (China) RoHS standards. The table below acknowledges the presences of small quantities of certain materials in the product, and is applicable to China RoHS only.

A label will be placed on each product to indicate the estimated “Environmentally Friendly Use Period” (EFUP). This is an estimate of the number of years that these substances would “not leak out or undergo abrupt change.” This product may contain replaceable sub-assemblies/components which have a shorter EFUP such as batteries and lamps. These components will be separately marked.

Please refer to the table on the next page.

Part Name	Toxic or Hazardous Substances and Elements					
	Lead (Pb)	Mercury (Hg)	Cadmium (Cd)	Hexavalent Chromium (CR(VI))	Polybrominated Biphenyls (PBB)	Polybrominated Diphenyl Ethers (PBDE)
Housing	X	O	O	O	O	X
Display	X	O	O	O	O	X
Printed Circuit Board	X	O	O	O	O	X
Metal Fasteners	X	O	O	O	O	O
Cable Assembly	X	O	O	O	O	X
Fan Assembly	X	O	O	O	O	X
Power Supply Assemblies	X	O	O	O	O	X
Battery	O	O	O	O	O	O
<p>O: This toxic or hazardous substance is contained in all of the homogeneous materials for the part is below the limit requirement in SJ/T11363-2006</p> <p>X: This toxic or hazardous substance is contained in at least one of the homogeneous materials for this part is above the limit requirement in SJ/T11363-2006</p>						

## KINO-G410 Mini-ITX Motherboard

此附件旨在确保本产品符合中国 RoHS 标准。以下表格标示此产品中某有毒物质的含量符合中国 RoHS 标准规定的限量要求。

本产品上会附有“环境友好使用期限”的标签，此期限是估算这些物质“不会有泄漏或突变”的年限。本产品可能包含有较短的环境友好使用期限的可替换元件，像是电池或灯管，这些元件将会单独标示出来。

部件名称	有毒有害物质或元素					
	铅 (Pb)	汞 (Hg)	镉 (Cd)	六价铬 (CR(VI))	多溴联苯 (PBB)	多溴二苯 醚 (PBDE)
壳体	X	O	O	O	O	X
显示	X	O	O	O	O	X
印刷电路板	X	O	O	O	O	X
金属螺帽	X	O	O	O	O	O
电缆组装	X	O	O	O	O	X
风扇组装	X	O	O	O	O	X
电力供应组装	X	O	O	O	O	X
电池	O	O	O	O	O	O

O: 表示该有毒有害物质在该部件所有物质材料中的含量均在 SJ/T11363-2006 标准规定的限量要求以下。  
X: 表示该有毒有害物质至少在该部件的某一均质材料中的含量超出 SJ/T11363-2006 标准规定的限量要求。