

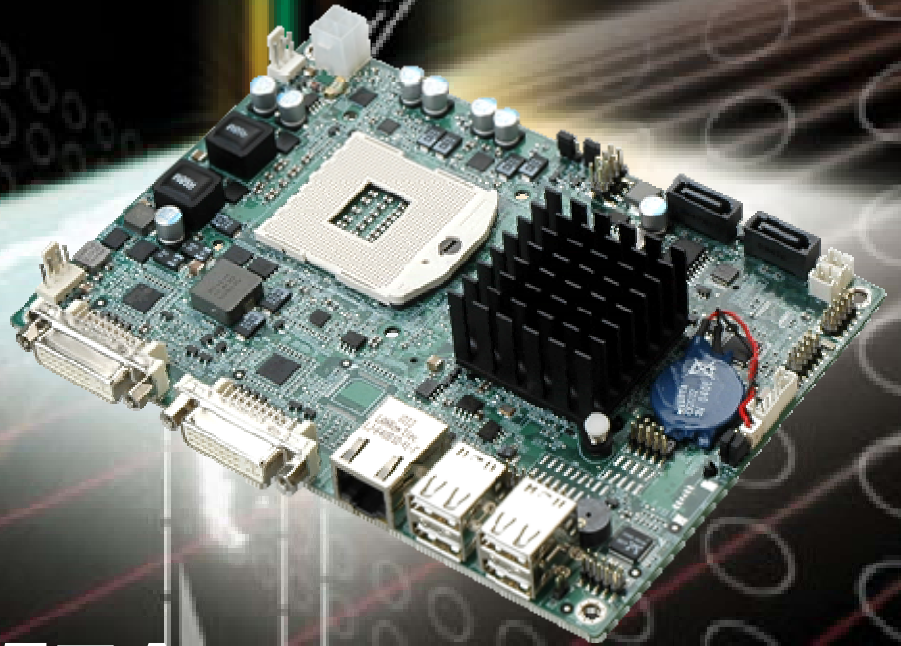

IEI Technology Corp.



**MODEL:  
NANO-QM57A**

**EPIC Motherboard Supports Socket G1 Intel® Core™ i3/i5/i7  
CPU, Dual DVI, GbE, Eight USB 2.0, Two SATA 3Gb/s,  
PCIe mini and iAMT 6.0**

## **User Manual**

Rev. 1.01 - 16 August, 2011



# Revision

---

<b>Date</b>	<b>Version</b>	<b>Changes</b>
16 August, 2011	1.01	Modified operating temperature information
9 July, 2010	1.00	Initial release

# Copyright

---

## **COPYRIGHT NOTICE**

The information in this document is subject to change without prior notice in order to improve reliability, design and function and does not represent a commitment on the part of the manufacturer.

In no event will the manufacturer be liable for direct, indirect, special, incidental, or consequential damages arising out of the use or inability to use the product or documentation, even if advised of the possibility of such damages.

This document contains proprietary information protected by copyright. All rights are reserved. No part of this manual may be reproduced by any mechanical, electronic, or other means in any form without prior written permission of the manufacturer.

## **TRADEMARKS**

All registered trademarks and product names mentioned herein are used for identification purposes only and may be trademarks and/or registered trademarks of their respective owners.

# Table of Contents

<b>1 INTRODUCTION.....</b>	<b>1</b>
1.1 INTRODUCTION.....	2
1.2 CONNECTORS .....	2
1.3 DIMENSIONS.....	3
1.4 DATA FLOW .....	5
1.5 TECHNICAL SPECIFICATIONS .....	6
<b>2 UNPACKING .....</b>	<b>8</b>
2.1 ANTI-STATIC PRECAUTIONS .....	9
2.2 UNPACKING PRECAUTIONS.....	9
2.3 PACKING LIST.....	10
2.3.1 <i>Optional Items</i> .....	11
<b>3 CONNECTORS .....</b>	<b>12</b>
3.1 PERIPHERAL INTERFACE CONNECTORS.....	13
3.1.1 <i>NANO-QM57A Layout</i> .....	13
3.1.2 <i>Peripheral Interface Connectors</i> .....	14
3.1.3 <i>External Interface Panel Connectors</i> .....	14
3.2 INTERNAL PERIPHERAL CONNECTORS .....	15
3.2.1 <i>Audio Connector</i> .....	15
3.2.2 <i>Battery Connector</i> .....	16
3.2.3 <i>BIOS Update Connector</i> .....	17
3.2.4 <i>Fan Connector (CPU)</i> .....	17
3.2.5 <i>Fan Connector (System)</i> .....	18
3.2.6 <i>Front Panel Connector</i> .....	19
3.2.7 <i>Keyboard/Mouse Connector</i> .....	20
3.2.8 <i>PCIe Mini Card Slot</i> .....	21
3.2.9 <i>12V Power Connector</i> .....	22
3.2.10 <i>SATA Drive Connectors</i> .....	23
3.2.11 <i>SATA Power Connectors</i> .....	24
3.2.12 <i>Serial Port Connectors (RS-232)</i> .....	25

## NANO-QM57A EPIC SBC

3.2.13 <i>USB Connectors</i> .....	25
3.3 EXTERNAL PERIPHERAL INTERFACE CONNECTOR PANEL .....	26
3.3.1 <i>DVI Connector</i> .....	27
3.3.2 <i>Ethernet Connector</i> .....	28
3.3.3 <i>USB Connectors</i> .....	29
<b>4 INSTALLATION .....</b>	<b>30</b>
4.1 ANTI-STATIC PRECAUTIONS .....	31
4.2 INSTALLATION CONSIDERATIONS.....	32
4.2.1 <i>Installation Notices</i> .....	32
4.3 UNPACKING.....	33
4.4 CPU, CPU COOLING KIT AND SO-DIMM INSTALLATION.....	33
4.4.1 <i>Socket G CPU Installation</i> .....	34
4.4.2 <i>Socket G Cooling Kit Installation</i> .....	36
4.4.3 <i>SO-DIMM Installation</i> .....	38
4.5 JUMPER SETTINGS .....	38
4.5.1 <i>AT Auto Button Power Select Jumper Settings</i> .....	39
4.5.2 <i>AT/ATX Power Select Jumper Settings</i> .....	40
4.5.3 <i>Clear CMOS Jumper</i> .....	41
4.5.4 <i>ME RTC Register Jumper</i> .....	42
4.5.5 <i>ME RTC Flash Security Override Jumper</i> .....	43
4.6 CHASSIS INSTALLATION.....	43
4.6.1 <i>Airflow</i> .....	43
4.6.2 <i>Motherboard Installation</i> .....	44
4.7 INTERNAL PERIPHERAL DEVICE CONNECTIONS.....	44
4.7.1 <i>AT/ATX Power Connection</i> .....	44
4.7.2 <i>Audio Kit Installation</i> .....	46
4.7.3 <i>Single RS-232 Cable (w/o Bracket)</i> .....	47
4.8 EXTERNAL PERIPHERAL INTERFACE CONNECTION .....	48
4.8.1 <i>DVI Display Device Connection</i> .....	49
4.8.2 <i>LAN Connection (Single Connector)</i> .....	50
4.8.3 <i>USB Connection (Dual Connector)</i> .....	51
4.8.4 <i>VGA Monitor Connection</i> .....	52
4.9 SOFTWARE INSTALLATION .....	53
<b>5 BIOS SCREENS.....</b>	<b>56</b>



5.1 INTRODUCTION.....	57
5.1.1 Starting Setup.....	57
5.1.2 Using Setup.....	57
5.1.3 Getting Help.....	58
5.1.4 Unable to Reboot After Configuration Changes.....	58
5.1.5 BIOS Menu Bar.....	58
5.2 MAIN.....	59
5.3 ADVANCED.....	60
5.3.1 ACPI Configuration.....	61
5.3.2 CPU Configuration.....	62
5.3.3 SATA Configuration.....	63
5.3.4 USB Configuration.....	64
5.3.5 Super IO Configuration.....	66
5.3.5.1 Serial Port n Configuration.....	66
5.3.6 H/W Monitor.....	69
5.3.7 AMT Configuration.....	74
5.3.8 Serial Port Console Redirection.....	75
5.3.8.1 Console Redirection Settings.....	76
5.4 CHIPSET.....	77
5.4.1 Northbridge Configuration.....	78
5.4.2 Southbridge Configuration.....	79
5.4.3 Integrated Graphics.....	81
5.5 BOOT.....	82
5.6 SECURITY.....	84
5.7 EXIT.....	85
<b>A INTEL® AMT CONFIGURATION.....</b>	<b>87</b>
A.1 INTEL® AMT SETUP PROCEDURE.....	88
A.2 INTEL® MANAGEMENT ENGINE BIOS EXTENSION.....	88
A.3 IEI EASY MANAGER APPLICATION.....	93
<b>B BIOS MENU OPTIONS.....</b>	<b>94</b>
<b>C ONE KEY RECOVERY.....</b>	<b>96</b>
C.1 ONE KEY RECOVERY INTRODUCTION.....	97
C.1.1 System Requirement.....	97

## NANO-QM57A EPIC SBC

<i>C.1.2 Supported Operating System</i> .....	97
C.2 SETUP PROCEDURE FOR WINDOWS .....	99
<i>C.2.1 Hardware and BIOS Setup</i> .....	100
<i>C.2.2 Create Partitions</i> .....	100
<i>C.2.3 Install Operating System, Drivers and Applications</i> .....	103
<i>C.2.4 Build-up Recovery Partition</i> .....	103
<i>C.2.5 Create Factory Default Image</i> .....	106
C.3 SETUP PROCEDURE FOR LINUX .....	111
C.4 RECOVERY TOOL FUNCTIONS .....	114
<i>C.4.1 Factory Restore</i> .....	116
<i>C.4.2 Backup System</i> .....	117
<i>C.4.3 Restore Your Last Backup</i> .....	118
<i>C.4.4 Manual</i> .....	119
<b>D TERMINOLOGY</b> .....	<b>120</b>
<b>E WATCHDOG TIMER</b> .....	<b>125</b>
<b>F HAZARDOUS MATERIALS DISCLOSURE</b> .....	<b>128</b>
F.1 HAZARDOUS MATERIAL DISCLOSURE TABLE FOR IPB PRODUCTS CERTIFIED AS ROHS COMPLIANT UNDER 2002/95/EC WITHOUT MERCURY .....	129

# List of Figures

---

Figure 1-1: NANO-QM57A .....	2
Figure 1-2: Connectors .....	3
Figure 1-3: NANO-QM57A Dimensions (mm).....	4
Figure 1-4: Data Flow Block Diagram .....	5
Figure 3-1: Connector and Jumper Locations.....	13
Figure 3-2: Audio Connector Location .....	15
Figure 3-3: Battery Connector Location.....	16
Figure 3-4: BIOS Update Connector Locations .....	17
Figure 3-5: CPU Fan Connector Location .....	18
Figure 3-6: +12V Fan Connector Locations .....	19
Figure 3-7: Front Panel Connector Location .....	20
Figure 3-8: Keyboard/Mouse Connector Location .....	20
Figure 3-9: PCIe Mini Card Slot Location .....	21
Figure 3-10: CPU 12V Power Connector Location .....	23
Figure 3-11: SATA Drive Connector Locations .....	23
Figure 3-12: SATA Power Connector Locations .....	24
Figure 3-13: COM Connector Pinout Locations .....	25
Figure 3-14: USB Connector Pinout Locations .....	26
Figure 3-15: NANO-QM57A External Peripheral Interface Connector.....	27
Figure 3-16: RJ-45 Ethernet Connector.....	29
Figure 4-1: Make sure the CPU socket retention screw is unlocked .....	35
Figure 4-2: Lock the CPU Socket Retention Screw.....	36
Figure 4-3: Cooling Kit Support Bracket.....	37
Figure 4-4: SO-DIMM Installation .....	38
Figure 4-5: Jumper Locations .....	38
Figure 4-6: AT Auto Button Select Jumper Settings.....	40
Figure 4-7: AT/ATX Power Select Jumper Location.....	40
Figure 4-8: Clear CMOS Jumper .....	42
Figure 4-9: ME RTC Register Jumper Location.....	42
Figure 4-10: ME RTC Security Override Jumper Location .....	43
Figure 4-11: Power Cable to Motherboard Connection .....	45



## NANO-QM57A EPIC SBC

Figure 4-12: Connect Power Cable to Power Supply.....	46
Figure 4-13: Audio Kit Cable Connection .....	47
Figure 4-14: Single RS-232 Cable Installation .....	48
Figure 4-15: DVI Connector .....	50
Figure 4-16: LAN Connection .....	51
Figure 4-17: USB Connector.....	52
Figure 4-18: VGA Connector .....	53
Figure 4-19: Introduction Screen .....	54
Figure 4-20: Available Drivers .....	55
Figure A-1: Intel® Active Management Technology Status Dialog .....	88
Figure A-2: Intel® Current ME Password .....	89
Figure A-3: Intel® ME New Password.....	90
Figure A-4: Intel® AMT Configuration .....	90
Figure A-5: Select KVM Configuration .....	91
Figure A-6: KVM Configuration .....	91
Figure A-7: KVM User Opt-in.....	92
Figure A-8: Exit .....	92
Figure C-1: Recovery Tool Setup Menu .....	101
Figure C-2: Command Mode.....	101
Figure C-3: Partition Creation Commands.....	102
Figure C-4: System Configuration for Windows .....	104
Figure C-5: Build-up Recovery Partition .....	105
Figure C-6: Press any key to continue .....	105
Figure C-7: Press F3 to Boot into Recovery Mode.....	106
Figure C-8: Recovery Tool Menu .....	106
Figure C-9: About Symantec Ghost Window.....	107
Figure C-10: Symantec Ghost Path .....	107
Figure C-11: Select a Local Source Drive .....	108
Figure C-12: Select a Source Partition from Basic Drive .....	108
Figure C-13: File Name to Copy Image to .....	109
Figure C-14: Compress Image.....	109
Figure C-15: Image Creation Confirmation .....	110
Figure C-16: Image Creation Complete .....	110
Figure C-17: Image Creation Complete .....	110
Figure C-18: Press Any Key to Continue .....	111



**Figure C-19: Partitions for Linux..... 112**

**Figure C-20: System Configuration for Linux..... 113**

**Figure C-21: Access menu.lst in Linux (Text Mode)..... 113**

**Figure C-22: Recovery Tool Menu ..... 114**

**Figure C-23: Recovery Tool Main Menu ..... 115**

**Figure C-24: Restore Factory Default..... 116**

**Figure C-25: Recovery Complete Window ..... 116**

**Figure C-26: Backup System..... 117**

**Figure C-27: System Backup Complete Window ..... 117**

**Figure C-28: Restore Backup ..... 118**

**Figure C-29: Restore System Backup Complete Window ..... 118**

**Figure C-30: Symantec Ghost Window ..... 119**

# List of Tables

<b>Table 1-1: Technical Specifications</b> .....	<b>7</b>
<b>Table 3-1: Peripheral Interface Connectors</b> .....	<b>14</b>
<b>Table 3-2: Rear Panel Connectors</b> .....	<b>15</b>
<b>Table 3-3: Audio Connector Pinouts</b> .....	<b>16</b>
<b>Table 3-4: Battery Connector Pinouts</b> .....	<b>17</b>
<b>Table 3-5: BIOS Update Connector Pinouts</b> .....	<b>17</b>
<b>Table 3-6: CPU Fan Connector Pinouts</b> .....	<b>18</b>
<b>Table 3-7: +12V Fan Connector Pinouts</b> .....	<b>19</b>
<b>Table 3-8: Front Panel Connector Pinouts</b> .....	<b>20</b>
<b>Table 3-9: Keyboard/Mouse Connector Pinouts</b> .....	<b>21</b>
<b>Table 3-10: PCIe Mini Card Slot Pinouts</b> .....	<b>22</b>
<b>Table 3-11: CPU 12V Power Connector Pinouts</b> .....	<b>23</b>
<b>Table 3-12: SATA Drive Connector Pinouts</b> .....	<b>24</b>
<b>Table 3-13: SATA Power Connector Pinouts</b> .....	<b>24</b>
<b>Table 3-14: COM Connector Pinouts</b> .....	<b>25</b>
<b>Table 3-15: USB Port Connector Pinouts</b> .....	<b>26</b>
<b>Table 3-16: DVI Connector Pinouts</b> .....	<b>28</b>
<b>Table 3-17: LAN Pinouts</b> .....	<b>28</b>
<b>Table 3-18: RJ-45 Ethernet Connector LEDs</b> .....	<b>29</b>
<b>Table 3-19: USB Port Connector Pinouts</b> .....	<b>29</b>
<b>Table 4-1: Jumpers</b> .....	<b>39</b>
<b>Table 4-2: AT Auto Button Power Select Jumper Settings</b> .....	<b>39</b>
<b>Table 4-3: AT/ATX Power Select Jumper Settings</b> .....	<b>40</b>
<b>Table 4-4: Clear CMOS Jumper Settings</b> .....	<b>41</b>
<b>Table 4-5: ME RTC Register Jumper Settings</b> .....	<b>42</b>
<b>Table 4-6: ME RTC Security Override Jumper Settings</b> .....	<b>43</b>
<b>Table 5-1: BIOS Navigation Keys</b> .....	<b>58</b>

# List of BIOS Menus

---

BIOS Menu 1: Main .....	59
BIOS Menu 2: Advanced .....	60
BIOS Menu 3: ACPI Configuration .....	61
BIOS Menu 4: CPU Configuration .....	62
BIOS Menu 5: IDE Configuration .....	63
BIOS Menu 6: USB Configuration .....	64
BIOS Menu 7: Super IO Configuration.....	66
BIOS Menu 8: Serial Port n Configuration Menu.....	66
BIOS Menu 9: Hardware Health Configuration .....	69
BIOS Menu 10: AMT Configuration.....	74
BIOS Menu 11: Serial Port Console Redirection .....	75
BIOS Menu 12: Console Redirection Settings.....	76
BIOS Menu 13: Chipset .....	77
BIOS Menu 14:Northbridge Chipset Configuration.....	78
BIOS Menu 15:Southbridge Chipset Configuration .....	79
BIOS Menu 16: Intel IGD SWSCI OpRegion .....	81
BIOS Menu 17: Boot .....	82
BIOS Menu 18: Security .....	84
BIOS Menu 19:Exit.....	85

Chapter

1

# Introduction

---



## 1.1 Introduction

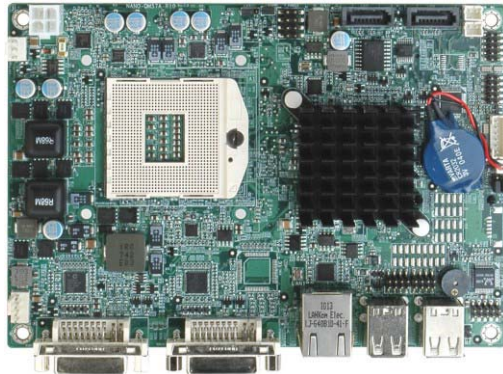

**Figure 1-1: NANO-QM57A**

The NANO-QM57A EPIC motherboard is a Socket G1 32nm Intel® Core™ i3, i5 and i7 processor platform. Up to one 4.0 GB 800 MHz or 1066 MHz DDR3 SDRAM SO-DIMM is supported by the NANO-QM57A.

The integrated Intel® QM57 Express Chipset supports one GbE LAN port through the Intel® 82577 Ethernet controller (with iAMT 6.0 support). The NANO-QM57A also supports two SATA 3Gb/s drives and provides 5 V SATA power.

The NANO-QM57A supports multiple display devices, including dual DVI or DVI and VGA (with DVI to VGA adapter). Eight USB 2.0 channels and one expansion PCIe mini socket provide flexible expansion options. High Definition Audio (HDA) support ensures HDA devices can be easily implemented on the NANO-QM57A.

## 1.2 Connectors

The connectors on the NANO-QM57A are shown in the figure below.

## NANO-QM57A EPIC SBC

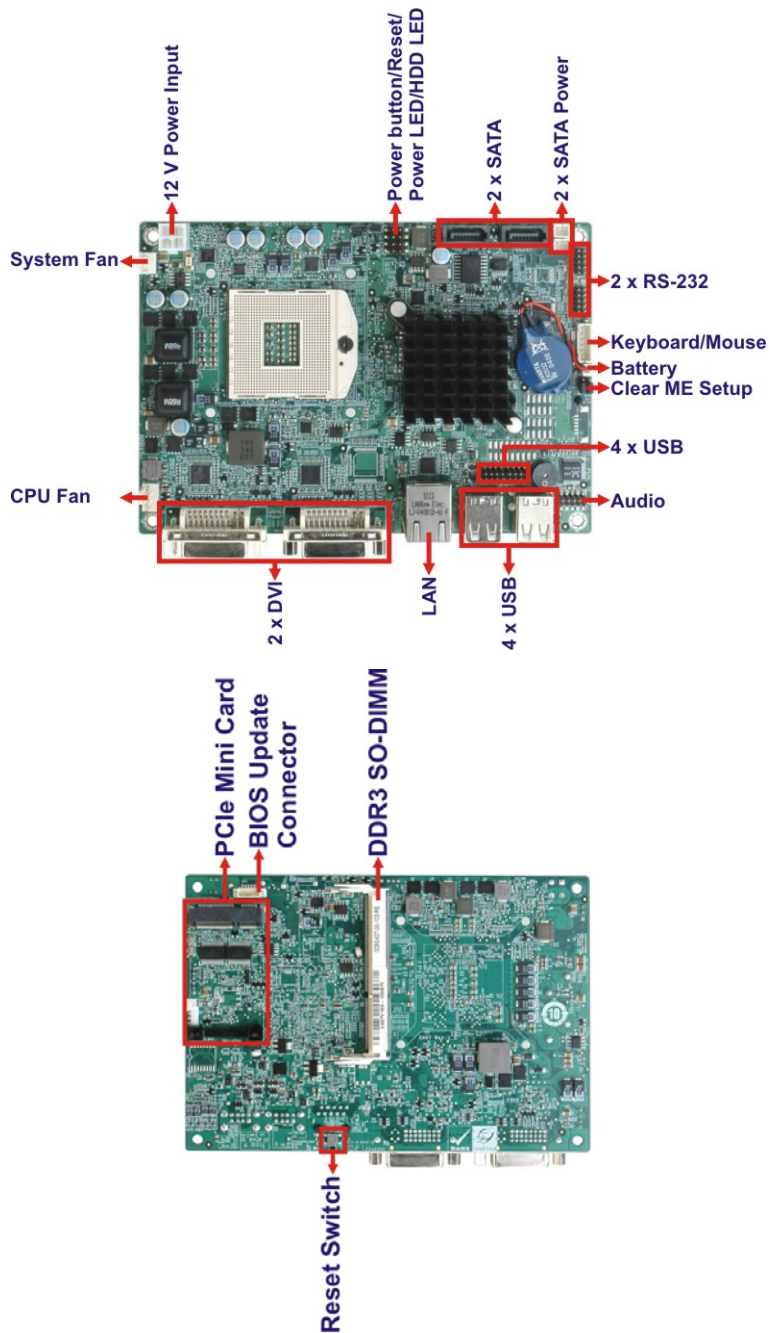

Figure 1-2: Connectors

### 1.3 Dimensions

The dimensions of the board are listed below:

- **Length:** 165 mm

- **Width:** 115 mm

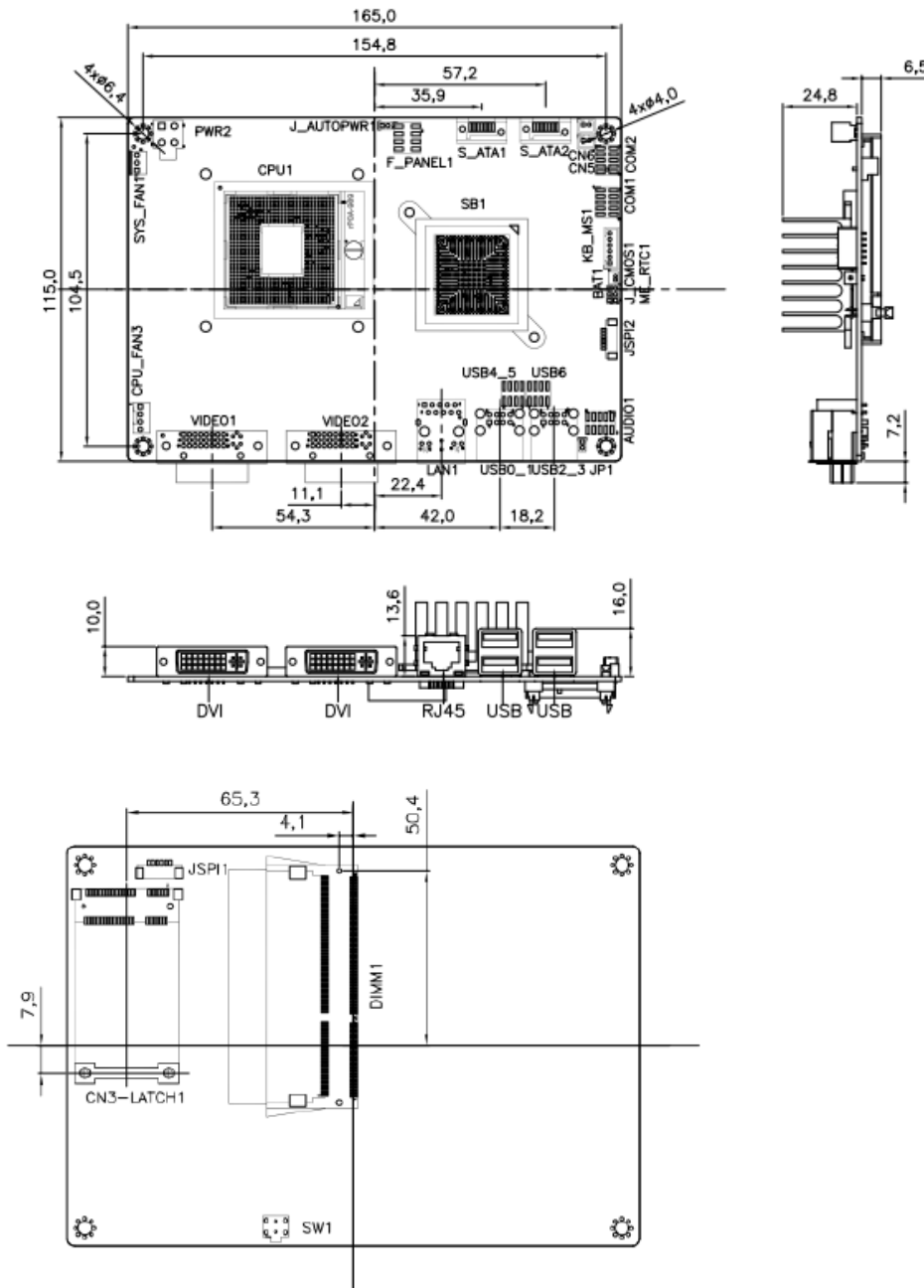

**Figure 1-3: NANO-QM57A Dimensions (mm)**



NANO-QM57A EPIC SBC

1.4 Data Flow

Figure 1-4 shows the data flow between the two on-board chipsets and other components installed on the motherboard and described in the following sections of this chapter.

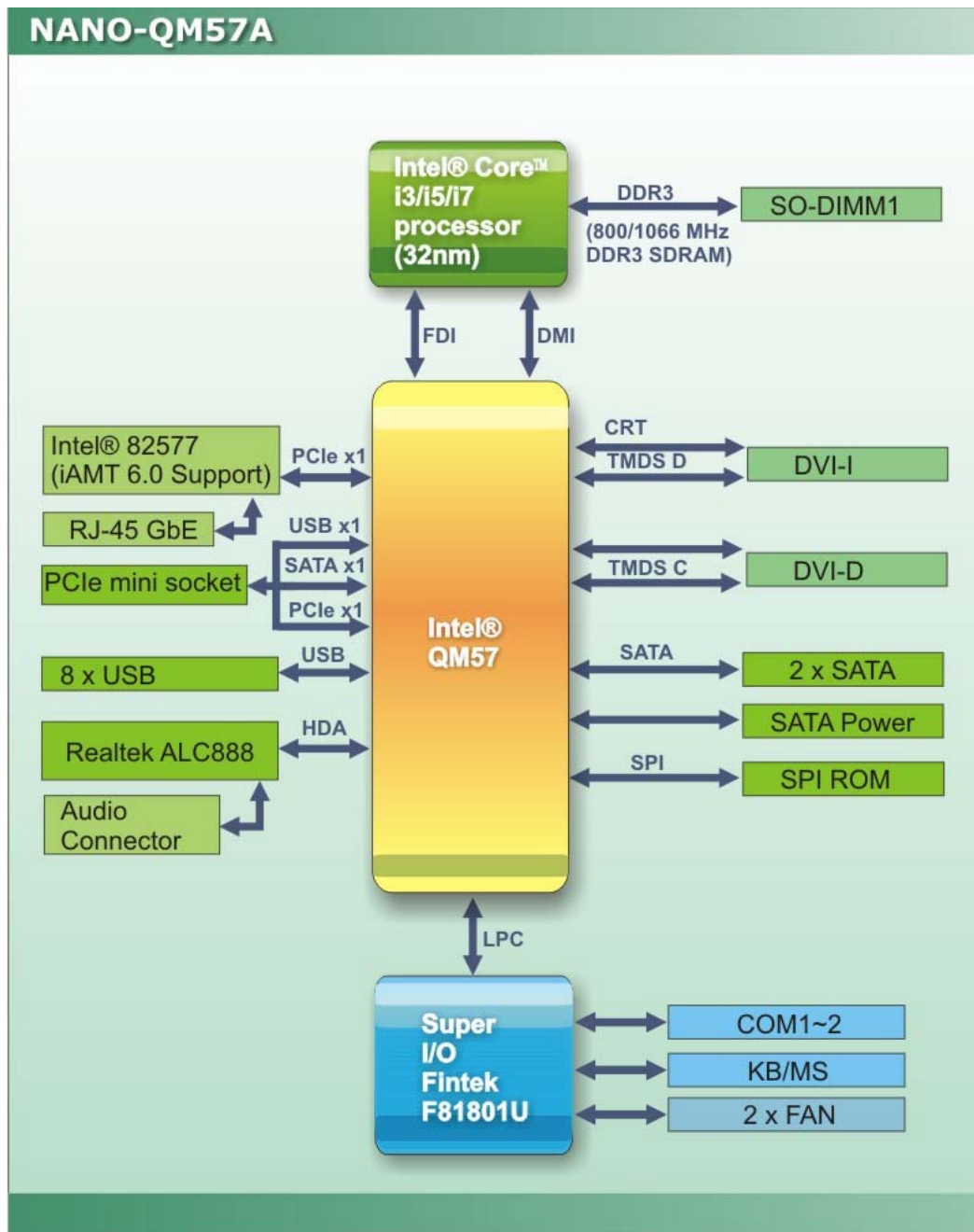

Figure 1-4: Data Flow Block Diagram

## 1.5 Technical Specifications

NANO-QM57A technical specifications are listed in table below.

Specification	NANO-QM57A
<b>Form Factor</b>	EPIC
<b>Socket</b>	Socket G1 (rPGA988A)
<b>CPU Supported</b>	32 nm Intel® Core™ i3 processor 32 nm Intel® Core™ i5 processor 32 nm Intel® Core™ i7 processor
<b>Express Chipset</b>	Intel® QM57
<b>Memory</b>	One 204-pin SO-DIMM sockets support one 800/1066 MHz 4.0 GB (max.) DDR3 SDRAM SO-DIMM (system max. 4 GB)
<b>Audio</b>	Realtek ALC888 HD 7.1 channel audio codec
<b>LAN</b>	One Intel® 82577 PCIe GbE controller with iAMT 6.0 support
<b>Super I/O</b>	Fintek F81801U
<b>BIOS</b>	AMI BIOS label
<b>Watchdog Timer</b>	Software programmable supports 1~255 sec. system reset
<b>Expansion</b>	
<b>PCIe</b>	One PCIe Mini slot
<b>I/O Interface Connectors</b>	
<b>Audio Connector</b>	One internal audio connector (10-pin header)
<b>Display Ports</b>	One DVI-I (DVI-D + VGA) port One DVI-D port
<b>Ethernet</b>	One RJ-45 GbE port
<b>Serial Ports</b>	Two RS-232 via two 10-pin headers
<b>USB 2.0/1.1 Ports</b>	Four external USB ports Four internal USB ports via two 8-pin headers
<b>Storage</b>	



## NANO-QM57A EPIC SBC

Specification	NANO-QM57A
<b>Serial ATA</b>	Two SATA 3.0 Gb/s connectors with RAID 0,1 support Two 5V SATA power connectors
<b>Environmental and Power Specifications</b>	
<b>Power Supply</b>	12 V only ATX and AT power supported
<b>Power Connector</b>	One internal 4-pin Molex power connector for power supply
<b>Power Consumption</b>	12V@4.66A 2.66 GHz Intel® Core™ i7 620M CPU with one 1333 MHz 2 GB DDR3 SO-DIMM
<b>Operating Temperature</b>	-10°C ~ 60°C (requires cooler and silicone heat sink paste)
<b>Humidity</b>	5% ~ 95% (non-condensing)
<b>Physical Specifications</b>	
<b>Dimensions</b>	165 mm x 115 mm
<b>Weight GW/NW</b>	850 g/350 g

Table 1-1: Technical Specifications

Chapter

2

# Unpacking

---

## NANO-QM57A EPIC SBC

### 2.1 Anti-static Precautions

---



#### **WARNING!**

Static electricity can destroy certain electronics. Make sure to follow the ESD precautions to prevent damage to the product, and injury to the user.

---

Make sure to adhere to the following guidelines:

- ***Wear an anti-static wristband:*** Wearing an anti-static wristband can prevent electrostatic discharge.
- ***Self-grounding:*** Touch a grounded conductor every few minutes to discharge any excess static buildup.
- ***Use an anti-static pad:*** When configuring any circuit board, place it on an anti-static mat.
- ***Only handle the edges of the PCB:*** Don't touch the surface of the motherboard. Hold the motherboard by the edges when handling.

### 2.2 Unpacking Precautions

When the NANO-QM57A is unpacked, please do the following:







- Follow the antistatic guidelines above.
- Make sure the packing box is facing upwards when opening.
- Make sure all the packing list items are present.

## 2.3 Packing List



**NOTE:**

If any of the components listed in the checklist below are missing, do not proceed with the installation. Contact the IEI reseller or vendor the NANO-QM57A was purchased from or contact an IEI sales representative directly by sending an email to [sales@iei.com.tw](mailto:sales@iei.com.tw).

The NANO-QM57A is shipped with the following components:







Quantity	Item and Part Number	Image
1	NANO-QM57A motherboard	
1	SATA and 5 V power cable (P/N: 32000-114000-RS)	
2	RS-232 serial port cable (P/N: 32200-000049-RS)	
1	DVI-I to VGA adaptor (P/N: 33Z00-000031-RS)	
1	AT 12 V Cable (P/N: 32100-087100-RS)	
1	Audio cable (P/N: 32000-072100-RS)	
1	Mini jumper pack (2.0mm) (P/N: 33100-000033-RS)	

## NANO-QM57A EPIC SBC

1	Utility CD	
1	Quick Installation Guide	

### 2.3.1 Optional Items

The following are optional components which may be separately purchased:

Item and Part Number	Image
CPU cooler (P/N: CF-989A-RS-R11)	
Dual USB cable (without bracket) (P/N: 32000-070301-RS)	
SATA power cable (P/N: 32100-088600-RS)	
SATA cable (P/N: 32000-062800-RS)	
SATA cable (P/N: 32000-112000-RS)	
Keyboard/Mouse cable (P/N: 32000-023800-RS)	



Chapter

3

# Connectors

---

# NANO-QM57A EPIC SBC

## 3.1 Peripheral Interface Connectors

This chapter details all the jumpers and connectors.

### 3.1.1 NANO-QM57A Layout

The figures below show all the connectors and jumpers.

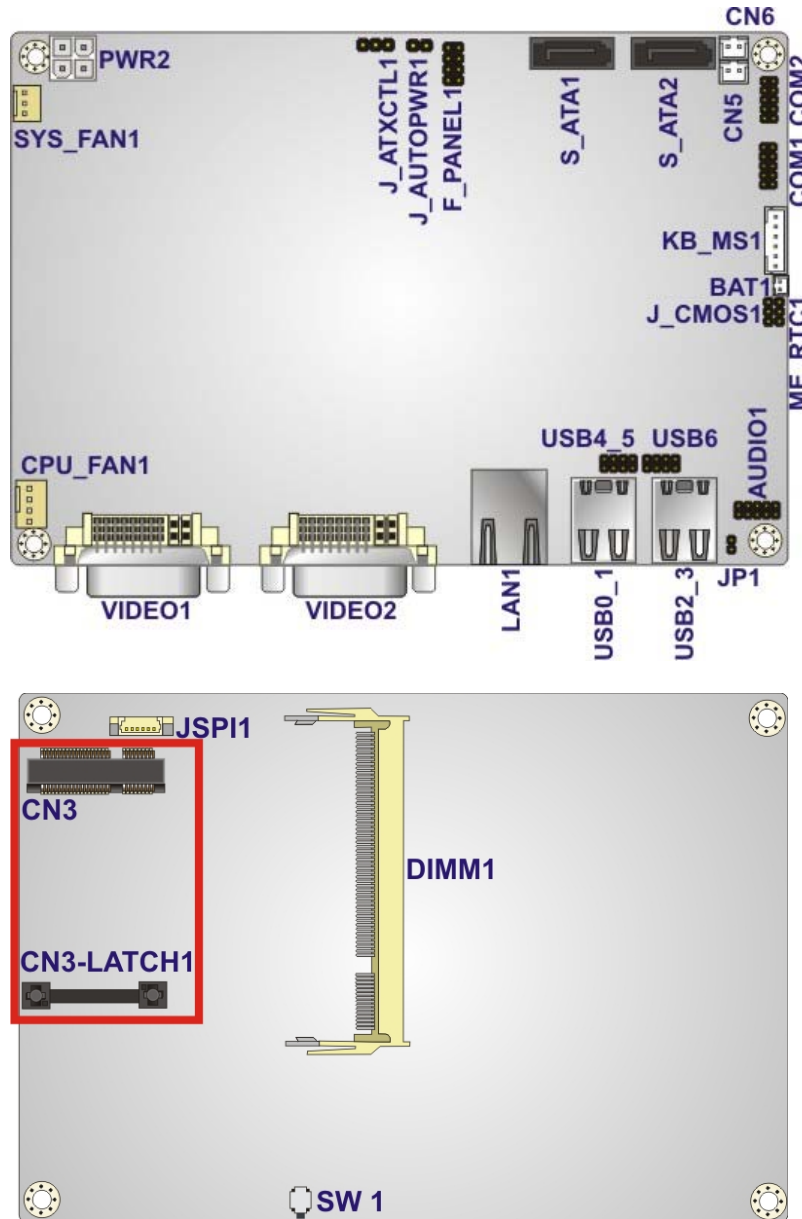

Figure 3-1: Connector and Jumper Locations

### 3.1.2 Peripheral Interface Connectors

The table below lists all the connectors on the board.

Connector	Type	Label
Audio connector	10-pin header	AUDIO1
Battery connector	2-pin wafer	BAT1
BIOS update connector	6-pin wafer	JSPI1
DDR3 SO-DIMM socket	204-pin socket	DIMM1
Fan connector (CPU)	4-pin wafer	CPU_FAN1
Fan connector (system)	3-pin wafer	SYS_FAN1
Front panel connector	8-pin header	F_PANEL1
Keyboard and mouse connector	6-pin wafer	KB_MS1
PCIe Mini card slot	PCIe Mini card slot	CN3
Power connector (+12V, power supply)	4-pin connector	PWR2
RS-232 serial port connector	10-pin header	COM1
RS-232 serial port connector	10-pin header	COM2
Serial ATA (SATA) drive connector	7-pin SATA	S_ATA1
Serial ATA (SATA) drive connector	7-pin SATA	S_ATA2
SATA power connector	2-pin wafer	CN5
SATA power connector	2-pin wafer	CN6
USB connector (1)	8-pin header	USB4_5
USB connector (2)	8-pin header	USB6

**Table 3-1: Peripheral Interface Connectors**

### 3.1.3 External Interface Panel Connectors

## NANO-QM57A EPIC SBC

The table below lists the connectors on the external I/O panel.

Connector	Type	Label
Ethernet connector	RJ-45	LAN1
DVI-I (DVI-D + VGA) port	DVI-I port	VIDEO1
DVI-D port	DVI-D port	VIDEO2
Reset Switch	Switch	SW1
USB ports (dual)	USB port	USB0_1
USB ports (dual)	USB port	USB2_3

**Table 3-2: Rear Panel Connectors**

## 3.2 Internal Peripheral Connectors

The section describes all of the connectors on the NANO-QM57A.

### 3.2.1 Audio Connector

- CN Label:**           **AUDIO1**
- CN Type:**           10-pin header (2x5)
- CN Location:**      See **Figure 3-2**
- CN Pinouts:**        See **Table 3-3**

The audio connector is connected to external audio devices including speakers and microphones for the input and output of audio signals to and from the system.

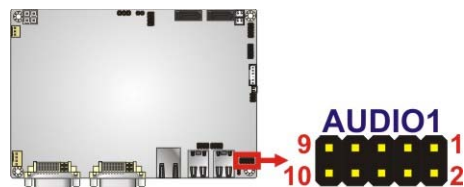

**Figure 3-2: Audio Connector Location**

PIN NO.	DESCRIPTION	PIN NO.	DESCRIPTION
1	LFRONT-R	2	LLINE-R
3	GND	4	GND
5	LFRONT-L	6	LLINE-L
7	GND	8	GND
9	LMIC1-CONN-R	10	LMIC1-CONN-L

**Table 3-3: Audio Connector Pinouts**

### 3.2.2 Battery Connector



**CAUTION:**

Risk of explosion if battery is replaced by an incorrect type. Only certified engineers should replace the on-board battery.

Dispose of used batteries according to instructions and local regulations.

- CN Label:**            **BAT1**
- CN Type:**            2-pin wafer (1x2)
- CN Location:**      See **Figure 3-3**
- CN Pinouts:**        See **Table 3-4**

This is connected to the system battery. The battery provides power to the system clock to retain the time when power is turned off.

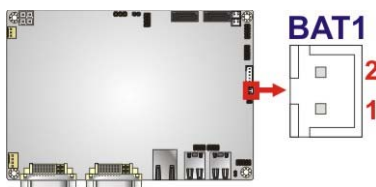

**Figure 3-3: Battery Connector Location**



## NANO-QM57A EPIC SBC

Pin	Description
1	Battery+
2	Ground

**Table 3-4: Battery Connector Pinouts**

### 3.2.3 BIOS Update Connector

<b>CN Label:</b>	<b>JSPI1</b>
<b>CN Type:</b>	6-pin wafer (1x6)
<b>CN Location:</b>	See <b>Figure 3-4</b>
<b>CN Pinouts:</b>	See <b>Table 3-5</b>

The connector is for BIOS updating only.

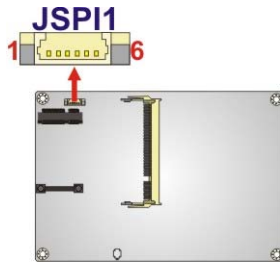

**Figure 3-4: BIOS Update Connector Locations**

Pin	Description	Pin	Description
1	+3.3V	2	SPI_CS#0_CN
3	SPI_S00_CN	4	SPI_CLK0_CN
5	SPI_S10_CN	6	GND

**Table 3-5: BIOS Update Connector Pinouts**

### 3.2.4 Fan Connector (CPU)

<b>CN Label:</b>	<b>CPU_FAN1</b>
<b>CN Type:</b>	4-pin wafer (1x4)

**CN Location:** See **Figure 3-5**

**CN Pinouts:** See **Table 3-6**

The fan connector attaches to a CPU cooling fan.

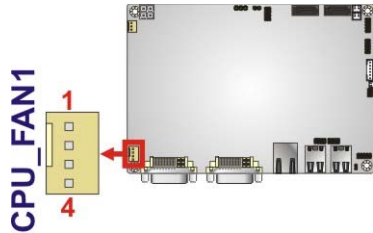

**Figure 3-5: CPU Fan Connector Location**

Pin	Description
1	GROUND
2	+12V
3	FANIO1
4	FANOUT1

**Table 3-6: CPU Fan Connector Pinouts**

### 3.2.5 Fan Connector (System)

**CN Label:** **SYS\_FAN1**

**CN Type:** 3-pin wafer (1x3)

**CN Location:** See **Figure 3-6**

**CN Pinouts:** See **Table 3-7**

The cooling fan connector provides a 12V, 500mA current to the cooling fan. The connector has a "rotation" pin to get rotation signals from fans and notify the system so the system BIOS can recognize the fan speed. Please note that only specified fans can issue the rotation signals.

## NANO-QM57A EPIC SBC

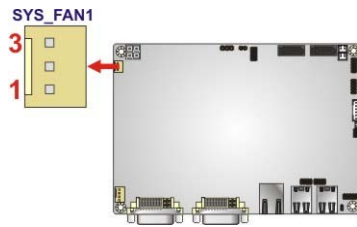

**Figure 3-6: +12V Fan Connector Locations**

PIN NO.	DESCRIPTION
1	N/C
2	+12V
3	GND

**Table 3-7: +12V Fan Connector Pinouts**

### 3.2.6 Front Panel Connector

<b>CN Label:</b>	<b>F_PANEL1</b>
<b>CN Type:</b>	8-pin header (2x4)
<b>CN Location:</b>	See <b>Figure 3-7</b>
<b>CN Pinouts:</b>	See <b>Table 3-8</b>

The front panel connector connects to external switches and indicators to monitor and controls the motherboard. These indicators and switches include:

- Power button
- Reset
- Power LED
- HDD LED

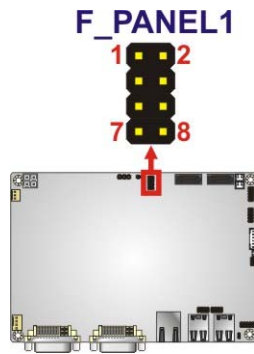

**Figure 3-7: Front Panel Connector Location**

FUNCTION	PIN	DESCRIPTION	FUNCTION	PIN	DESCRIPTION
Power Button	1	PWRBTN_SW#	Power LED	2	PWR LED
	3	GND		4	GND
SATA LED	5	SATA_LED_PWT	Reset	6	RESET
	7	SATA_LED#		8	GND

**Table 3-8: Front Panel Connector Pinouts**

### 3.2.7 Keyboard/Mouse Connector

- CN Label:** KB\_MS1
- CN Type:** 6-pin wafer (1x6)
- CN Location:** See **Figure 3-8**
- CN Pinouts:** See **Table 3-9**

The keyboard/mouse connector connects to a PS/2 Y-cable that can be connected to a PS/2 keyboard and mouse.

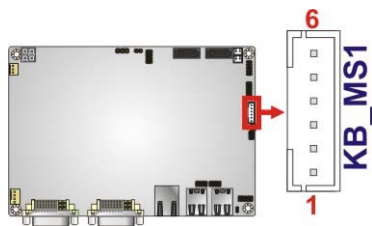

**Figure 3-8: Keyboard/Mouse Connector Location**

## NANO-QM57A EPIC SBC

Pin	Description
1	+5 VCC
2	MS DATA
3	MS CLK
4	KB DATA
5	KB CLK
6	GROUND

**Table 3-9: Keyboard/Mouse Connector Pinouts**

### 3.2.8 PCIe Mini Card Slot

- CN Label:** CN3
- CN Type:** PCIe Mini card slot
- CN Location:** See **Figure 3-9**
- CN Pinouts:** See **Table 3-10**

The PCIe Mini card slot is for installing PCIe Mini expansion cards.

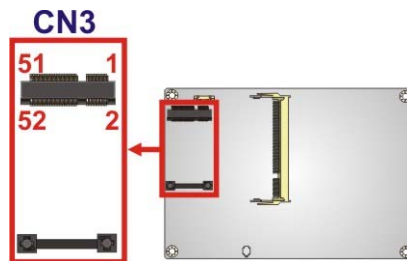

**Figure 3-9: PCIe Mini Card Slot Location**

Pin	Description	Pin	Description
1	PCIE_WAKE#	2	VCC3
3	N/C	4	GND
5	N/C	6	1.5 V
7	CLKREQ#	8	LFRAME#
9	GND	10	LAD3
11	CLK-	12	LAD2



Pin	Description	Pin	Description
13	CLK+	14	LAD1
15	GND	16	LAD0
17	PCIRST#	18	GND
19	LPC	20	VCC3
21	GND	22	PCIRST#
23	PERN2	24	3VDual
25	PERP2	26	GND
27	GND	28	1.5 V
29	GND	30	SMBCLK
31	PETN2	32	SMBDATA
33	PETP2	34	GND
35	GND	36	USB-
37	GND	38	USB+
39	VCC3	40	GND
41	VCC3	42	N/C
43	GND	44	RF_LINK#
45	SATATXP2/CL_CLK	46	BLUELED#
47	SATATXN2/CL_DATA	48	1.5 V
49	SATARXN2/CL_RST#	50	GND
51	SATARXP2	52	VCC3

**Table 3-10: PCIe Mini Card Slot Pinouts**

### 3.2.9 12V Power Connector

- CN Label:** PWR2
- CN Type:** 4-pin Molex power connector (1x4)
- CN Location:** See **Figure 3-10**
- CN Pinouts:** See **Table 3-11**

The connector supports the 12V power supply.

## NANO-QM57A EPIC SBC

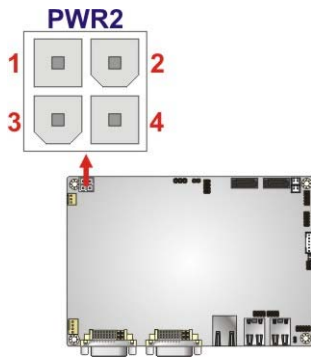

Figure 3-10: CPU 12V Power Connector Location

PIN NO.	DESCRIPTION	PIN NO.	DESCRIPTION
1	GND	2	GND
3	+12V	4	+12V

Table 3-11: CPU 12V Power Connector Pinouts

### 3.2.10 SATA Drive Connectors

- CN Label:** S\_ATA1, S\_ATA2
- CN Type:** 7-pin SATA drive connectors
- CN Location:** See Figure 3-11
- CN Pinouts:** See Table 3-12

The two SATA 3Gb/s drive connectors are each connected to a SATA 3Gb/s drive. The SATA 3Gb/s drives transfer data at speeds as high as 3.0 Gb/s.

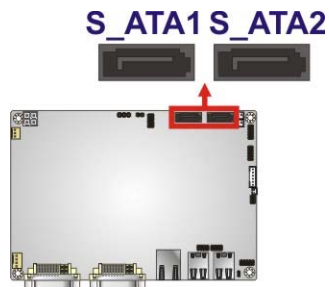

Figure 3-11: SATA Drive Connector Locations

PIN NO.	DESCRIPTION
1	GND
2	TX+
3	TX-
4	GND
5	RX-
6	RX+
7	GND

**Table 3-12: SATA Drive Connector Pinouts**

### 3.2.11 SATA Power Connectors

- CN Label:** CN5, CN6
- CN Type:** 2-pin wafer (1x2)
- CN Location:** See **Figure 3-12**
- CN Pinouts:** See **Table 3-13**

The SATA Power Connectors provides +5V power output to the SATA connectors.

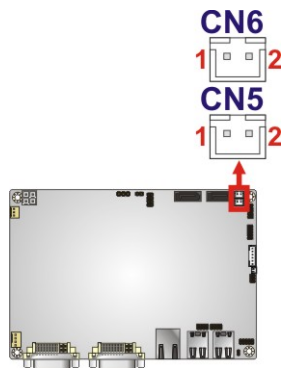

**Figure 3-12: SATA Power Connector Locations**

PIN NO.	DESCRIPTION
1	+5V
2	GND

**Table 3-13: SATA Power Connector Pinouts**

## NANO-QM57A EPIC SBC

### 3.2.12 Serial Port Connectors (RS-232)

<b>CN Label:</b>	<b>COM1 and COM2</b>
<b>CN Type:</b>	10-pin header (2x5)
<b>CN Location:</b>	See <b>Figure 3-13</b>
<b>CN Pinouts:</b>	See <b>Table 3-14</b>

These connectors provide RS-232 communications.

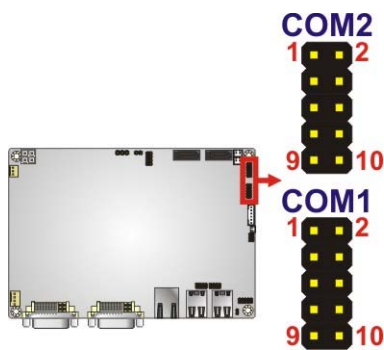

**Figure 3-13: COM Connector Pinout Locations**

PIN NO.	DESCRIPTION	PIN NO.	DESCRIPTION
1	Data Carrier Direct (DCD)	2	Data Set Ready (DSR)
3	Receive Data (RXD)	4	Request To Send (RTS)
5	Transmit Data (TXD)	6	Clear To Send (CTS)
7	Data Terminal Ready (DTR)	8	Ring Indicator (RI)
9	Ground (GND)	10	GND

**Table 3-14: COM Connector Pinouts**

### 3.2.13 USB Connectors

<b>CN Label:</b>	<b>USB4_5 and USB6</b>
<b>CN Type:</b>	8-pin header (2x4)
<b>CN Location:</b>	See <b>Figure 3-14</b>
<b>CN Pinouts:</b>	See <b>Table 3-19</b>

The USB connectors connect to USB devices. Each pin header provides two USB ports.



**Figure 3-14: USB Connector Pinout Locations**

PIN NO.	DESCRIPTION	PIN NO.	DESCRIPTION
1	VCC	2	GND
3	DATA-	4	DATA+
5	DATA+	6	DATA-
7	GND	8	VCC

**Table 3-15: USB Port Connector Pinouts**

### 3.3 External Peripheral Interface Connector Panel

**Figure 3-15** shows the NANO-QM57A external peripheral interface connector (EPIC) panel. The NANO-QM57A EPIC panel consists of the following:

- 1 x Ethernet connectors
- 2 x DVI connectors
- 1 x Reset switch
- 4 x USB connectors



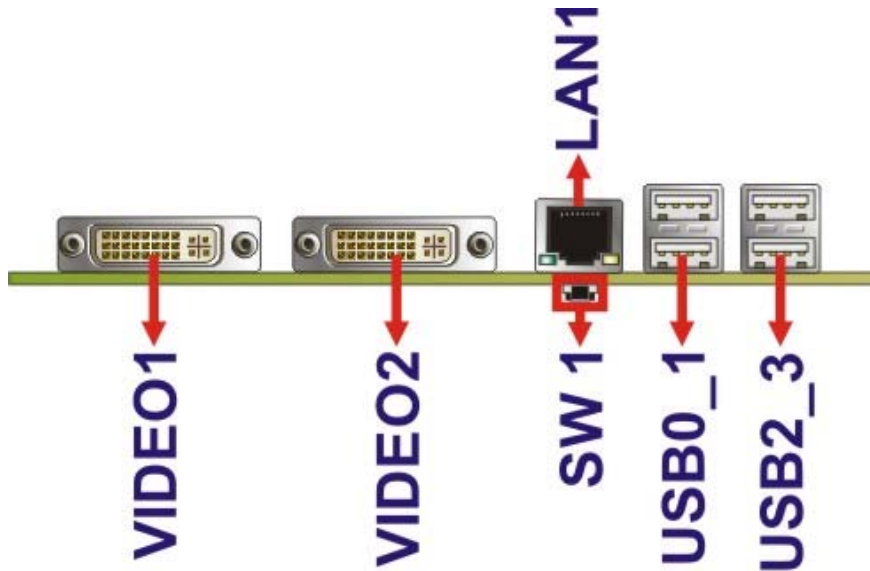

Figure 3-15: NANO-QM57A External Peripheral Interface Connector

### 3.3.1 DVI Connector

- CN Label:** VIDEO1, VIDEO2
- CN Type:** DVI connector
- CN Location:** See Figure 3-15
- CN Pinouts:** See Table 3-16

The 24-pin Digital Visual Interface (DVI) connector connects to high-speed, high-resolution digital displays. The DVI-I connector supports both digital and analog signals.

Pin	Description	Pin	Description	Pin	Description
1	TMDS Data2-	9	TMDS Data1-	17	TMDS Data0-
2	TMDS Data2+	10	TMDS Data1+	18	TMDS Data0+
3	GND	11	GND	19	GND
4	N/C	12	NC	20	NC
5	N/C	13	NC	21	NC
6	DDC Clock [SCL]	14	PVDD1	22	GND
7	DDC Data [SDA]	15	GND	23	TMDS Clock +
8	Analog vertical sync	16	GND	24	TMDS Clock -

Pin	Description	Pin	Description	Pin	Description
C1	Analog Red	--	--	--	--
C2	Analog Green	--	--	--	--
C3	Analog Blue	--	--	--	--
C4	Analog Horizontal Sync	--	--	--	--
C5	Analog GND	--	--	--	--

**Table 3-16: DVI Connector Pinouts**

### 3.3.2 Ethernet Connector

- CN Label:** LAN1
- CN Type:** RJ-45
- CN Location:** See **Figure 3-15**
- CN Pinouts:** See **Table 3-17**

The NANO-QM57A is equipped with two built-in RJ-45 Ethernet controllers. Each controller can connect to the LAN through one RJ-45 LAN connector.

PIN	DESCRIPTION	PIN	DESCRIPTION
1	LAN1_MDI0P	2	LAN1_MDI0N
3	LAN1_MDI1P	4	LAN1_MDI1N
5	+VCT_LAN1	6	GND
7	LAN1_MDI2P	8	LAN1_MDI2N
9	LAN1_MDI3P	10	LAN1_MDI3N

**Table 3-17: LAN Pinouts**

The RJ-45 Ethernet connector has two status LEDs, one green and one yellow. The green LED indicates activity on the port and the yellow LED indicates the speed. See **Table 3-18**.

## NANO-QM57A EPIC SBC

Speed LED		Activity/Link LED	
STATUS	DESCRIPTION	STATUS	DESCRIPTION
Off	10 Mbps connection	Off	No link
Green	100 Mbps connection	Yellow	Linked
Orange	Gbps connection	Blinking	TX/RX activity 1

**Table 3-18: RJ-45 Ethernet Connector LEDs**



**Figure 3-16: RJ-45 Ethernet Connector**

### 3.3.3 USB Connectors

**CN Label:**        **USB0\_1 and USB2\_3**

**CN Type:**        USB port

**CN Location:**    See **Figure 3-15**

**CN Pinouts:**     See **Table 3-19**

The NANO-QM57A has four external USB 2.0 ports. The ports connect to both USB 2.0 and USB 1.1 devices.

PIN NO.	DESCRIPTION	PIN NO.	DESCRIPTION
1	VCC	5	VCC
2	DATA-	6	DATA-
3	DATA+	7	DATA+
4	GROUND	8	GROUND

**Table 3-19: USB Port Connector Pinouts**

Chapter

4

# Installation

---

## 4.1 Anti-static Precautions

---



### WARNING:

Failure to take ESD precautions during the installation of the NANO-QM57A may result in permanent damage to the NANO-QM57A and severe injury to the user.

---

Electrostatic discharge (ESD) can cause serious damage to electronic components, including the NANO-QM57A. Dry climates are especially susceptible to ESD. It is therefore critical that whenever the NANO-QM57A or any other electrical component is handled, the following anti-static precautions are strictly adhered to.

- ***Wear an anti-static wristband:*** Wearing a simple anti-static wristband can help to prevent ESD from damaging the board.
- ***Self-grounding:*** Before handling the board, touch any grounded conducting material. During the time the board is handled, frequently touch any conducting materials that are connected to the ground.
- ***Use an anti-static pad:*** When configuring the NANO-QM57A, place it on an anti-static pad. This reduces the possibility of ESD damaging the NANO-QM57A.
- ***Only handle the edges of the PCB:*** When handling the PCB, hold the PCB by the edges.



## 4.2 Installation Considerations

---



### NOTE:

The following installation notices and installation considerations should be read and understood before the NANO-QM57A is installed. All installation notices pertaining to the installation of the NANO-QM57A should be strictly adhered to. Failing to adhere to these precautions may lead to severe damage of the NANO-QM57A and injury to the person installing the motherboard.

---

### 4.2.1 Installation Notices

---



### WARNING:

The installation instructions described in this manual should be carefully followed in order to prevent damage to the NANO-QM57A, NANO-QM57A components and injury to the user.

---

Before and during the installation please **DO** the following:

- Read the user manual:
  - The user manual provides a complete description of the NANO-QM57A installation instructions and configuration options.
- Wear an electrostatic discharge cuff (ESD):
  - Electronic components are easily damaged by ESD. Wearing an ESD cuff removes ESD from the body and helps prevent ESD damage.
- Place the NANO-QM57A on an antistatic pad:
  - When installing or configuring the motherboard, place it on an antistatic pad. This helps to prevent potential ESD damage.
- Turn all power to the NANO-QM57A off:

## NANO-QM57A EPIC SBC

- When working with the NANO-QM57A, make sure that it is disconnected from all power supplies and that no electricity is being fed into the system.

Before and during the installation of the NANO-QM57A **DO NOT**:

- Remove any of the stickers on the PCB board. These stickers are required for warranty validation.
- Use the product before verifying all the cables and power connectors are properly connected.
- Allow screws to come in contact with the PCB circuit, connector pins, or its components.

### 4.3 Unpacking

When the NANO-QM57A is unpacked, please check all the unpacking list items listed in Chapter 3 are indeed present. If any of the unpacking list items are not available please contact the NANO-QM57A vendor reseller/vendor where the NANO-QM57A was purchased or contact an IEI sales representative.

### 4.4 CPU, CPU Cooling Kit and SO-DIMM Installation



#### **WARNING:**

A CPU should never be turned on without the specified cooling kit being installed. If the cooling kit (heat sink and fan) is not properly installed and the system turned on, permanent damage to the CPU, NANO-QM57A and other electronic components attached to the system may be incurred. Running a CPU without a cooling kit may also result in injury to the user.

The CPU, CPU cooling kit and DIMM are the most critical components of the NANO-QM57A. If one of these component is not installed the NANO-QM57A cannot run.

#### 4.4.1 Socket G CPU Installation

---

**WARNING:**

CPUs are expensive and sensitive components. When installing the CPU please be careful not to damage it in anyway. Make sure the CPU is installed properly and ensure the correct cooling kit is properly installed.

---

To install a socket G CPU onto the NANO-QM57A, follow the steps below:

---

**WARNING:**

When handling the CPU, only hold it on the sides. DO NOT touch the pins at the bottom of the CPU.

---

**Step 1: Unlock the CPU retention screw.** When shipped, the retention screw of the CPU socket should be in the unlocked position. If it is not in the unlocked position, use a screwdriver to unlock the screw. See **Figure 4-1**.

## NANO-QM57A EPIC SBC

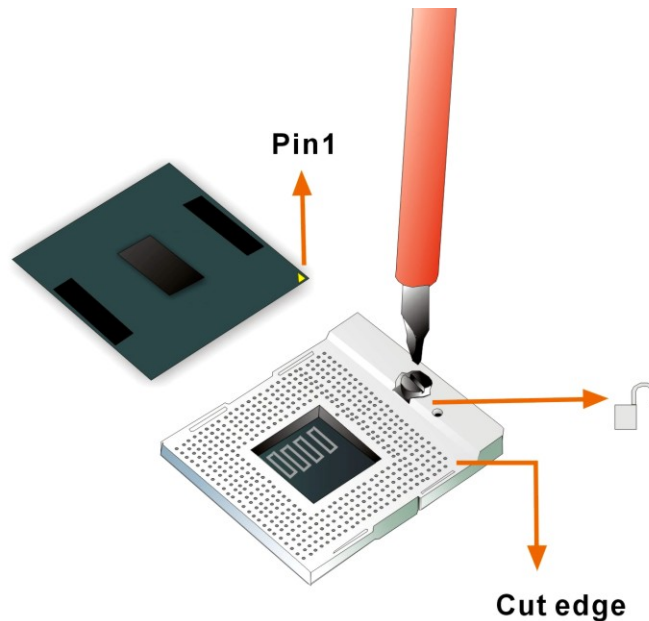

**Figure 4-1: Make sure the CPU socket retention screw is unlocked**

- Step 2: Inspect the CPU socket.** Make sure there are no bent pins and make sure the socket contacts are free of foreign material. If any debris is found, remove it with compressed air.
- Step 3: Correctly Orientate the CPU.** Make sure the IHS (integrated heat sink) side is facing upwards.
- Step 4: Correctly position the CPU.** Match the Pin 1 mark with the cut edge on the CPU socket. See **Figure 4-1**.
- Step 5: Align the CPU pins.** Carefully align the CPU pins with the holes in the CPU socket.
- Step 6: Insert the CPU.** Gently insert the CPU into the socket. If the CPU pins are properly aligned, the CPU should slide into the CPU socket smoothly.
- Step 7: Lock the retention screw.** Rotate the retention screw into the locked position. See **Figure 4-2**.

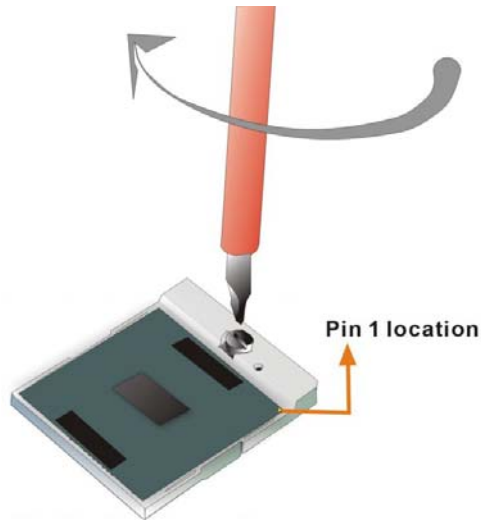

Figure 4-2: Lock the CPU Socket Retention Screw

#### 4.4.2 Socket G Cooling Kit Installation

An IEI Socket G CPU cooling kit can be purchased separately. (See **Chapter 3**) The cooling kit comprises a CPU heat sink and a cooling fan.



#### **WARNING:**

Do not wipe off (accidentally or otherwise) the pre-sprayed layer of thermal paste on the bottom of the heat sink. The thermal paste between the CPU and the heat sink is important for optimum heat dissipation.

To install the cooling kit, please follow the steps below.

**Step 1: Install the cooling kit bracket.** A cooling kit bracket is installed on the rear of the motherboard. Align the bracket with the four retention holes at the back of the motherboard. Once properly aligned, insert four retention screws from the front of the motherboard.



## NANO-QM57A EPIC SBC

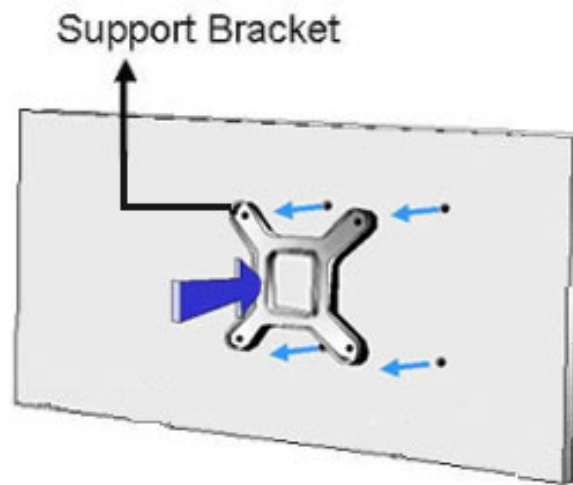
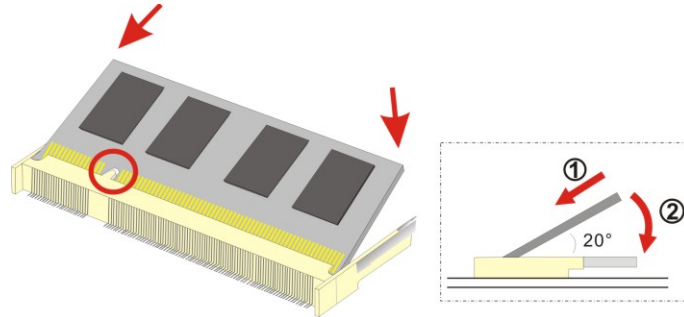

Figure 4-3: Cooling Kit Support Bracket

- Step 2:** **Open the lever at the top of the heat sink.** Lift the lever at the top of the cooling kit to loosen the cooling kit clamps.
- Step 3:** **Secure the cooling kit.** Gently place the heat sink and cooling kit onto the CPU. Make sure the hooks are properly secured to the bracket. To secure the cooling kit, close the top lever.
- Step 4:** **Connect the fan cable.** Connect the cooling kit fan cable to the fan connector on the NANO-QM57A. Carefully route the cable and avoid heat generating chips and fan blades.

### 4.4.3 SO-DIMM Installation

To install an SO-DIMM, please follow the steps below and refer to **Figure 4-4**.



**Figure 4-4: SO-DIMM Installation**

- Step 1:** Locate the SO-DIMM socket. Place the board on an anti-static mat.
- Step 2:** Align the SO-DIMM with the socket. Align the notch on the memory with the notch on the memory socket.
- Step 3:** Insert the SO-DIMM. Push the memory in at a 20° angle. (See **Figure 4-4**)
- Step 4:** Seat the SO-DIMM. Gently push downwards and the arms clip into place. (See **Figure 4-4**)

## 4.5 Jumper Settings



**NOTE:**

A jumper is a metal bridge used to close an electrical circuit. It consists of two or three metal pins and a small metal clip (often protected by a plastic cover) that slides over the pins to connect them. To CLOSE/SHORT a jumper means connecting the pins of the jumper with the plastic clip and to OPEN a jumper means removing the plastic clip from a jumper.

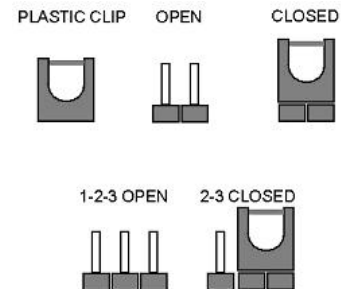

**Figure 4-5: Jumper Locations**

## NANO-QM57A EPIC SBC

Before the NANO-QM57A is installed in the system, the jumpers must be set in accordance with the desired configuration. The jumpers on the NANO-QM57A are listed in **Table 4-1**.

Description	Type	Label
AT Auto Button	2-pin header	J_AUTOPWR1
AT/ATX Power Mode Setting	3-pin header	J_ATXCTL1
Clear CMOS	3-pin header	J_CMOS1
ME RTC Register	3-pin header	ME_RTC1
ME RTC Security Override	2-pin header	JP1

**Table 4-1: Jumpers**

### 4.5.1 AT Auto Button Power Select Jumper Settings

<b>Jumper Label:</b>	<b>J_AUTOPWR1</b>
<b>Jumper Type:</b>	2-pin header
<b>Jumper Settings:</b>	See <b>Table 4-3</b>
<b>Jumper Location:</b>	See <b>Figure 4-6</b>

The AT Auto Button Power Select jumper specifies the systems auto button power mode as AT or ATX.

Setting	Description
Short	Use AT power
Open	Use ATX power

**Table 4-2: AT Auto Button Power Select Jumper Settings**

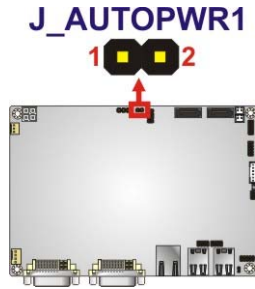

Figure 4-6: AT Auto Button Select Jumper Settings

#### 4.5.2 AT/ATX Power Select Jumper Settings

- Jumper Label:** J\_ATXCTL1
- Jumper Type:** 3-pin header (1x3)
- Jumper Settings:** See Table 4-3
- Jumper Location:** See Figure 4-7

The AT/ATX Power Select jumper specifies the systems power mode as AT or ATX. AT/ATX Power Select jumper settings are shown in **Table 4-3**.

AT Power Select	Description	
Short 1 - 2	Use ATX power	
Short 2 – 3	Use AT power	Default

Table 4-3: AT/ATX Power Select Jumper Settings

The location of the AT/ATX Power Select jumper is shown in **Figure 4-7** below.

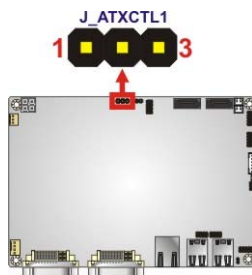

Figure 4-7: AT/ATX Power Select Jumper Location

## NANO-QM57A EPIC SBC

### 4.5.3 Clear CMOS Jumper

<b>Jumper Label:</b>	<b>J_CMOS1</b>
<b>Jumper Type:</b>	3-pin header (1x3)
<b>Jumper Settings:</b>	See <b>Table 4-4</b>
<b>Jumper Location:</b>	See <b>Figure 4-8</b>

If the NANO-QM57A fails to boot due to improper BIOS settings, the clear CMOS jumper clears the CMOS data and resets the system BIOS information. To do this, use the jumper cap to close pins 2 and 3 for a few seconds then reinstall the jumper clip back to pins 1 and 2.

If the “CMOS Settings Wrong” message is displayed during the boot up process, the fault may be corrected by pressing the F1 to enter the CMOS Setup menu. Do one of the following:

- Enter the correct CMOS setting
- Load Optimal Defaults
- Load Failsafe Defaults.

After having done one of the above, save the changes and exit the CMOS Setup menu.

The clear CMOS jumper settings are shown in **Table 4-4**.

Clear CMOS	Description	
<b>Short 1 - 2</b>	Keep CMOS Setup	Default
<b>Short 2 - 3</b>	Clear CMOS Setup	

**Table 4-4: Clear CMOS Jumper Settings**

The location of the clear CMOS jumper is shown in **Figure 4-8** below.



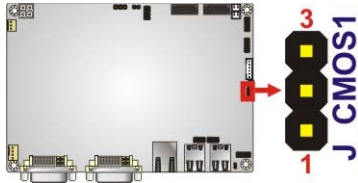

Figure 4-8: Clear CMOS Jumper

#### 4.5.4 ME RTC Register Jumper

- Jumper Label:** ME\_RTC1
- Jumper Type:** 3-pin header
- Jumper Settings:** See Table 4-5
- Jumper Location:** See Figure 4-9

The ME RTC Register jumper saves or clears the ME RTC registers. The ME RTC Register jumper settings are shown in Table 4-4.

Setting	Description	
Short 1-2	Save ME RTC registers (normal operation)	Default
Short 2-3	Clear ME RTC registers	

Table 4-5: ME RTC Register Jumper Settings

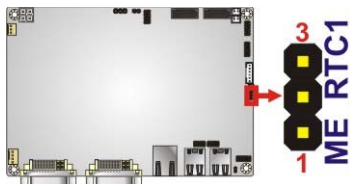

Figure 4-9: ME RTC Register Jumper Location

## NANO-QM57A EPIC SBC

### 4.5.5 ME RTC Flash Security Override Jumper

<b>Jumper Label:</b>	<b>JP1</b>
<b>Jumper Type:</b>	2-pin header
<b>Jumper Settings:</b>	See <b>Table 4-6</b>
<b>Jumper Location:</b>	See <b>Figure 4-10</b>

The ME RTC Security Override jumper protects or overrides the ME RTC Flash security registers. The ME RTC Security Override jumper settings are shown in **Table 4-4**.

Setting	Description	
Open	Flash Security On	Default
Short	Flash Security Override	

**Table 4-6: ME RTC Security Override Jumper Settings**

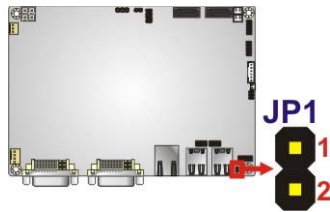

**Figure 4-10: ME RTC Security Override Jumper Location**

## 4.6 Chassis Installation

### 4.6.1 Airflow



#### **WARNING:**

Airflow is critical to the cooling of the CPU and other onboard components. The chassis in which the NANO-QM57A must have air vents to allow cool air to move into the system and hot air to move out.

The NANO-QM57A must be installed in a chassis with ventilation holes on the sides allowing airflow to travel through the heat sink surface. In a system with an individual

power supply unit, the cooling fan of a power supply can also help generate airflow through the board surface.

#### 4.6.2 Motherboard Installation

To install the NANO-QM57A motherboard into the chassis please refer to the reference material that came with the chassis.

### 4.7 Internal Peripheral Device Connections

This section outlines the installation of peripheral devices to the onboard connectors

#### 4.7.1 AT/ATX Power Connection

Follow the instructions below to connect the NANO-QM57A to an AT or ATX power supply.



#### **WARNING:**

Disconnect the power supply power cord from its AC power source to prevent a sudden power surge to the NANO-QM57A.

---

**Step 1:** **Locate the power cable.** The power cable is shown in the packing list in **Chapter 3.**

**Step 2:** **Connect the Power Cable to the Motherboard.** Connect the 4-pin (2x2) Molex type power cable connector to the AT/ATX power connector on the motherboard.

See Figure 4-11.

## NANO-QM57A EPIC SBC

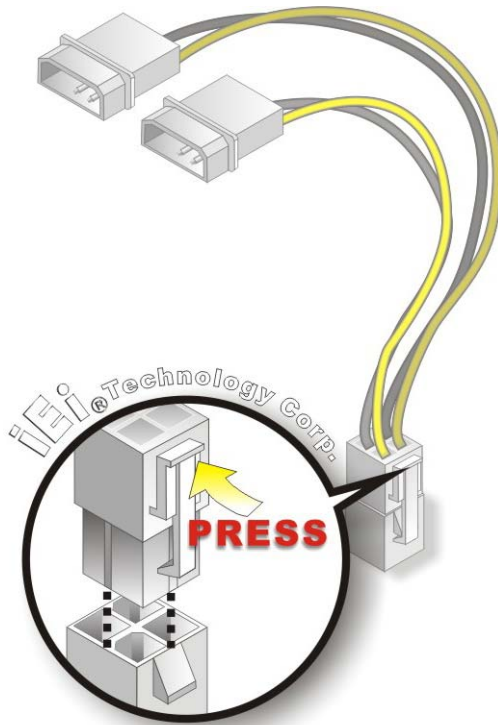

**Figure 4-11: Power Cable to Motherboard Connection**

**Step 3: Connect Power Cable to Power Supply.** Connect one of the 4-pin (1x4) Molex type power cable connectors to an AT/ATX power supply. See Figure 4-12.

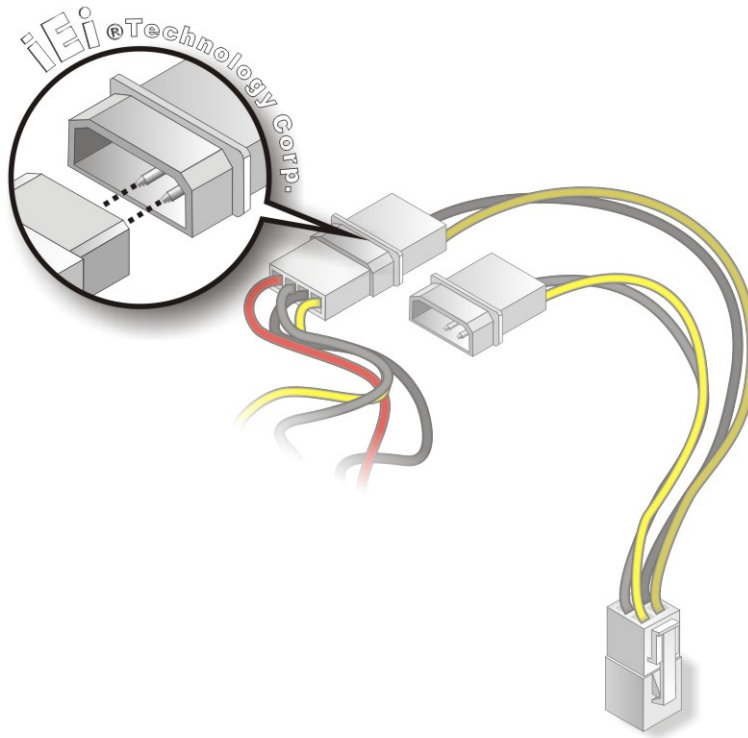

**Figure 4-12: Connect Power Cable to Power Supply**

### 4.7.2 Audio Kit Installation

The Audio Kit that came with the NANO-QM57A connects to the audio connector on the NANO-QM57A. The audio kit consists of three audio jacks. Mic-in connects to a microphone. Line-in provides a stereo line-level input to connect to the output of an audio device. Line-out, a stereo line-level output, connects to two amplified speakers. To install the audio kit, please refer to the steps below:

- Step 1:** **Locate the audio connector.** The location of the 10-pin audio connector is shown in **Chapter 3**.
- Step 2:** **Align pin 1.** Align pin 1 on the on-board connector with pin 1 on the audio kit connector. Pin 1 on the audio kit connector is indicated with a white dot. See Figure 4-13.



## NANO-QM57A EPIC SBC

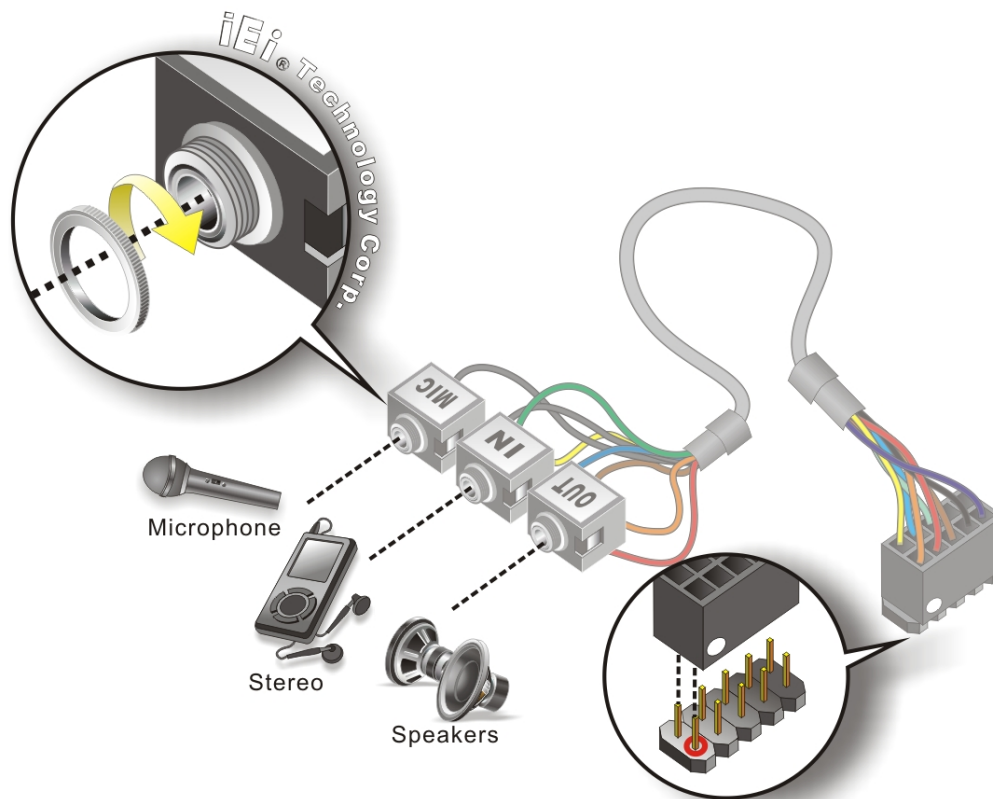

**Figure 4-13: Audio Kit Cable Connection**

**Step 3:** **Connect the audio devices.** Connect speakers to the line-out audio jack. Connect the output of an audio device to the line-in audio jack. Connect a microphone to the mic-in audio jack.

#### 4.7.3 Single RS-232 Cable (w/o Bracket)

The single RS-232 cable consists of one serial port connector attached to a serial communications cable that is then attached to a D-sub 9 male connector. To install the single RS-232 cable, please follow the steps below.

**Step 1:** **Locate the connector.** The location of the RS-232 connector is shown in Chapter 3.

**Step 2: Insert the cable connector.** Insert the connector into the serial port box header.

See Figure 4-14. A key on the front of the cable connectors ensures the connector can only be installed in one direction.

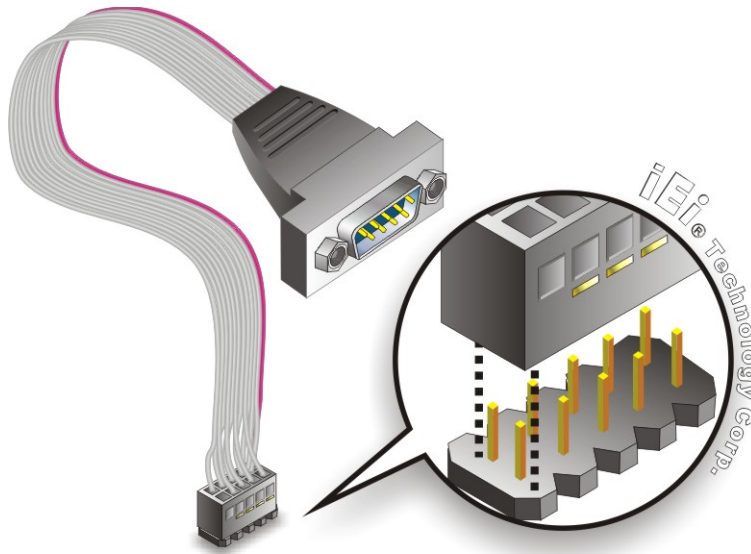

**Figure 4-14: Single RS-232 Cable Installation**

**Step 3: Secure the bracket.** The single RS-232 connector has two retention screws that must be secured to a chassis or bracket.

**Step 4: Connect the serial device.** Once the single RS-232 connector is connected to a chassis or bracket, a serial communications device can be connected to the system.

## 4.8 External Peripheral Interface Connection

The following external peripheral devices can be connected to the external peripheral interface connectors.

- DVI devices
- RJ-45 Ethernet cable connector
- USB devices
- VGA monitor

## NANO-QM57A EPIC SBC

To install these devices, connect the corresponding cable connector from the actual device to the corresponding NANO-QM57A external peripheral interface connector making sure the pins are properly aligned.

### 4.8.1 DVI Display Device Connection

The NANO-QM57A has one female DVI-I connector and one female DVI-D connector on the external peripheral interface panel. The DVI connectors are connected to digital display devices. To connect a digital display device to the NANO-QM57A, please follow the instructions below.

- Step 1: Locate the DVI-I connector.** The location of the DVI-I connector is shown in another chapter.
- Step 2: Align the DVI-I connector.** Align the male DVI-I connector on the digital display device cable with the female DVI-I connector on the external peripheral interface.
- Step 3: Insert the DVI-I connector** Once the connectors are properly aligned with the male connector, insert the male connector from the digital display device into the female connector on the NANO-QM57A. See Figure 4-15.

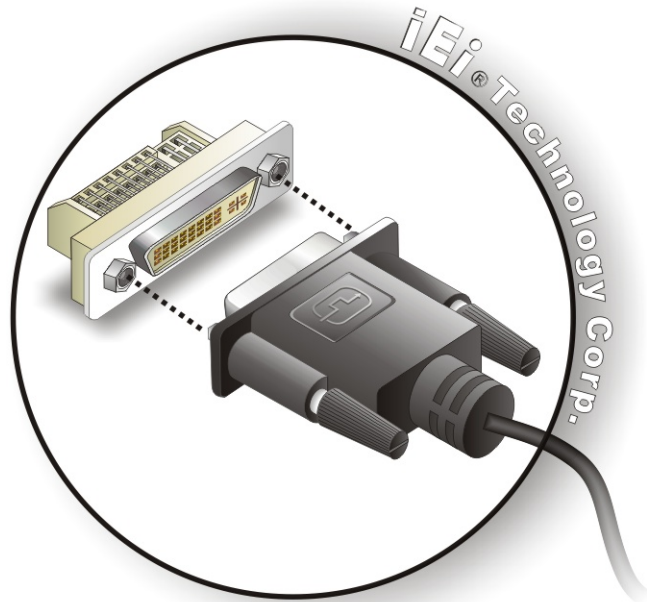

**Figure 4-15: DVI Connector**

**Step 4: Secure the connector.** Secure the DVI-I connector from the digital display device to the external interface by tightening the two retention screws on either side of the connector.

#### 4.8.2 LAN Connection (Single Connector)

There is one external RJ-45 LAN connector. The RJ-45 connector enables connection to an external network. To connect a LAN cable with an RJ-45 connector, please follow the instructions below.

**Step 1: Locate the RJ-45 connectors.** The location of the LAN connector is shown in Chapter 4.

**Step 2: Align the connectors.** Align the RJ-45 connector on the LAN cable with one of the RJ-45 connectors on the NANO-QM57A. See Figure 4-16.



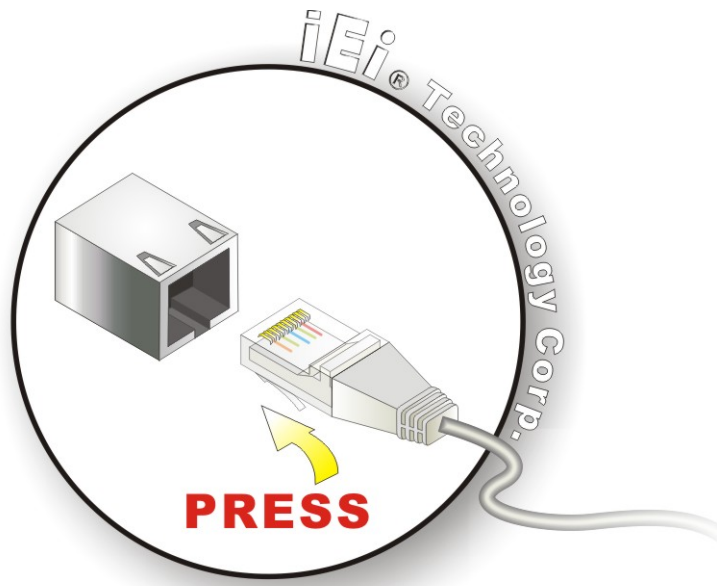

Figure 4-16: LAN Connection

**Step 3:** Insert the LAN cable RJ-45 connector. Once aligned, gently insert the LAN cable RJ-45 connector into the on-board RJ-45 connector.

### 4.8.3 USB Connection (Dual Connector)

The external USB Series "A" receptacle connectors provide easier and quicker access to external USB devices. Follow the steps below to connect USB devices to the NANO-QM57A.

**Step 1:** Locate the USB Series "A" receptacle connectors. The location of the USB Series "A" receptacle connectors are shown in **Chapter 3**.

**Step 2:** Insert a USB Series "A" plug. Insert the USB Series "A" plug of a device into the USB Series "A" receptacle on the external peripheral interface. See Figure 4-17.



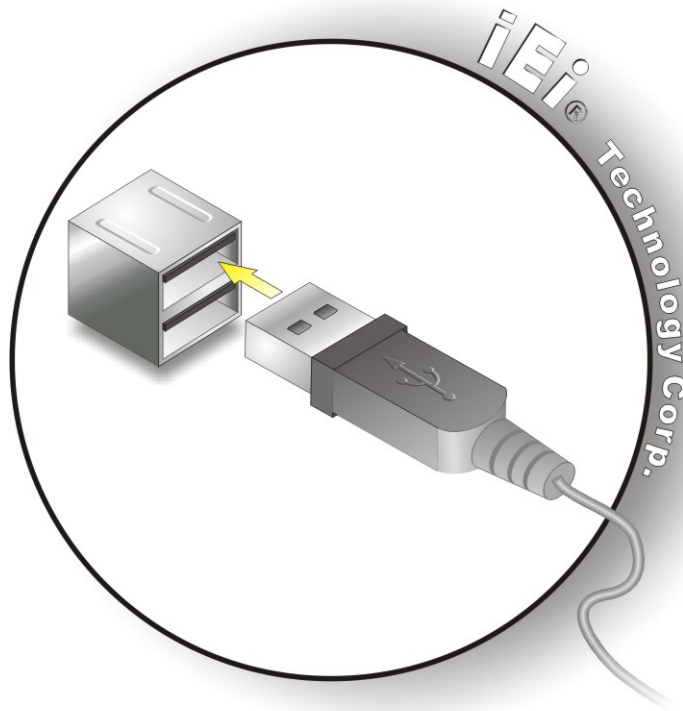

Figure 4-17: USB Connector

#### 4.8.4 VGA Monitor Connection

The NANO-QM57A is shipped with a DVI-I (male) to VGA adapter (female DB-15 connector) . The DB-15 connector is connected to a CRT or VGA monitor. To connect a monitor to the NANO-QM57A, please follow the instructions below.

- Step 1:** Locate the DVI-I connector (VIDEO2). The location of the VIDEO2 connector is shown in Chapter 3.
- Step 2:** Align the DVI-I to VGA adapter. Align the DVI-I (male) end of the DVI-I to VGA adapter with the VIDEO2 connector on the external peripheral interface.
- Step 3:** **Insert the DVI-I to VGA connector.** Once the connectors are properly aligned, insert male connector from the adapter into the female connector on the NANO-QM57A
- Step 4:** **Locate the female DB-15 connector** on the adapter.

## NANO-QM57A EPIC SBC

**Step 5: Align the VGA connector.** Align the male DB-15 connector on the VGA screen cable with the female DB-15 connector on the external peripheral interface.

**Step 6: Insert the VGA connector.** Once the connectors are properly aligned, insert the male connector from the VGA screen into the female connector on the NANO-QM57A. See **Figure 4-18**.

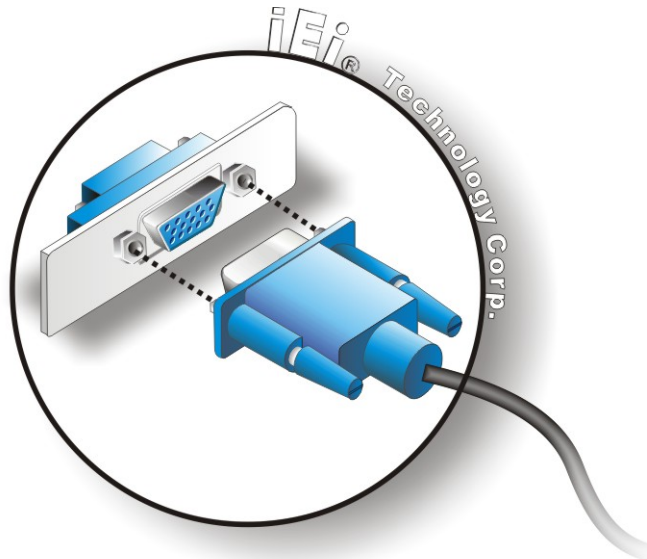

**Figure 4-18: VGA Connector**

**Step 7: Secure the connector.** Secure the DB-15 VGA connector from the VGA monitor to the external interface by tightening the two retention screws on either side of the connector.

## 4.9 Software Installation

All the drivers for the NANO-QM57A are on the CD that came with the system. To install the drivers, please follow the steps below.

**Step 1:** Insert the CD into a CD drive connected to the system.



**NOTE:**

If the installation program doesn't start automatically:  
Click "Start->My Computer->CD Drive->autorun.exe"

**Step 2:** The driver main menu appears (**Figure 4-19**).

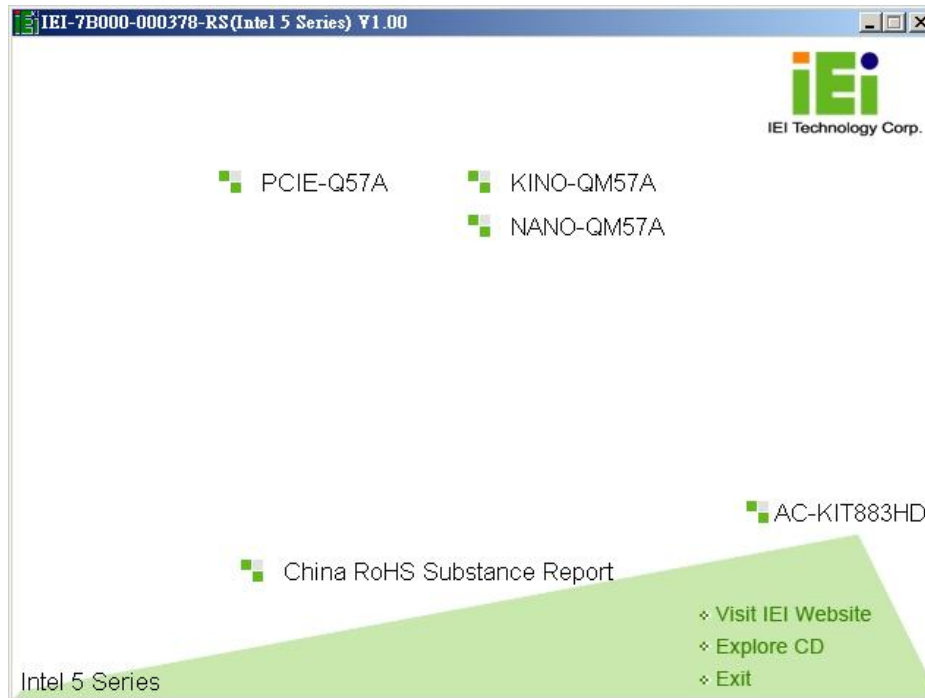
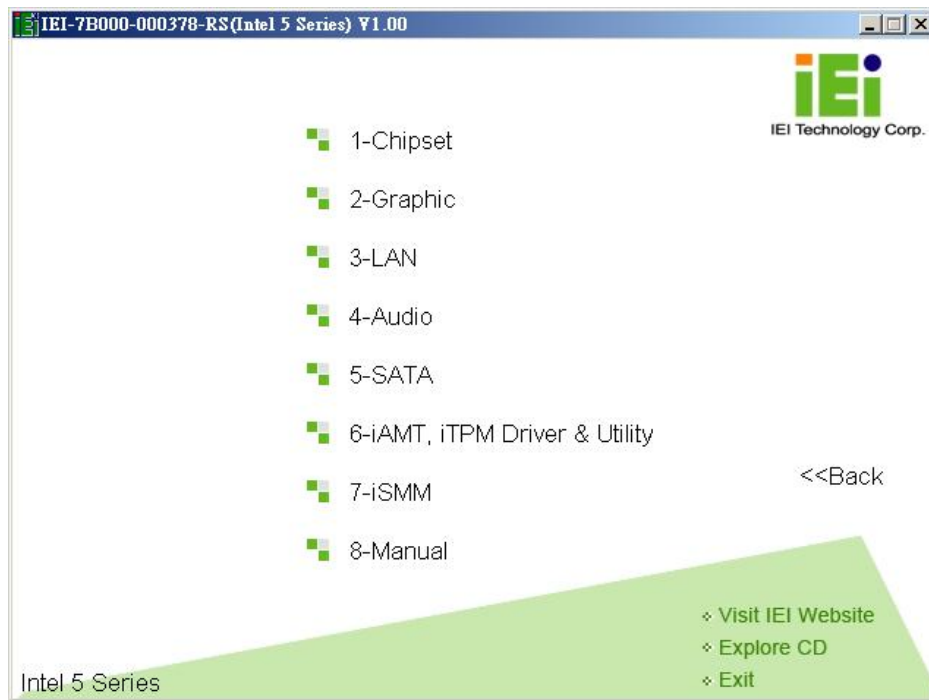

**Figure 4-19: Introduction Screen**

**Step 3:** Click **NANO-QM57A**.

**Step 4:** A new screen with a list of available drivers appears (**Figure 4-20**).

## NANO-QM57A EPIC SBC



**Figure 4-20: Available Drivers**

**Step 5:** Install all of the necessary drivers in this menu.

Chapter

5

# BIOS Screens

---



## 5.1 Introduction

The BIOS is programmed onto the BIOS chip. The BIOS setup program allows changes to certain system settings. This chapter outlines the options that can be changed.

### 5.1.1 Starting Setup

The AMI BIOS is activated when the computer is turned on. The setup program can be activated in one of two ways.

1. Press the **DELETE** key as soon as the system is turned on or
2. Press the **DELETE** key when the “**Press Del to enter SETUP**” message appears on the screen.

If the message disappears before the **DELETE** key is pressed, restart the computer and try again.

### 5.1.2 Using Setup

Use the arrow keys to highlight items, press **ENTER** to select, use the PageUp and PageDown keys to change entries, press **F1** for help and press **Esc** to quit. Navigation keys are shown in.

Key	Function
Up arrow	Move to previous item
Down arrow	Move to next item
Left arrow	Move to the item on the left hand side
Right arrow	Move to the item on the right hand side
Esc key	Main Menu – Quit and not save changes into CMOS Status Page Setup Menu and Option Page Setup Menu -- Exit current page and return to Main Menu
F1 key	General help, only for Status Page Setup Menu and Option Page Setup Menu
F2 key	Load previous values.
F3 key	Load optimized defaults

Key	Function
F4 key	Save all the CMOS changes

**Table 5-1: BIOS Navigation Keys**

### 5.1.3 Getting Help

When **F1** is pressed a small help window describing the appropriate keys to use and the possible selections for the highlighted item appears. To exit the Help Window press **Esc** or the **F1** key again.

### 5.1.4 Unable to Reboot After Configuration Changes

If the computer cannot boot after changes to the system configuration is made, CMOS defaults. Use the jumper described in Chapter 5.

### 5.1.5 BIOS Menu Bar

The **menu bar** on top of the BIOS screen has the following main items:

- Main – Changes the basic system configuration.
- Advanced – Changes the advanced system settings.
- Chipset – Changes the chipset settings.
- Boot – Changes the system boot configuration.
- Security – Sets User and Supervisor Passwords.
- Save & Exit – Selects exit options and loads default settings

The following sections completely describe the configuration options found in the menu items at the top of the BIOS screen and listed above.

## NANO-QM57A EPIC SBC

### 5.2 Main

The **Main** BIOS menu (**BIOS Menu 1**) appears when the **BIOS Setup** program is entered. The **Main** menu gives an overview of the basic system information.

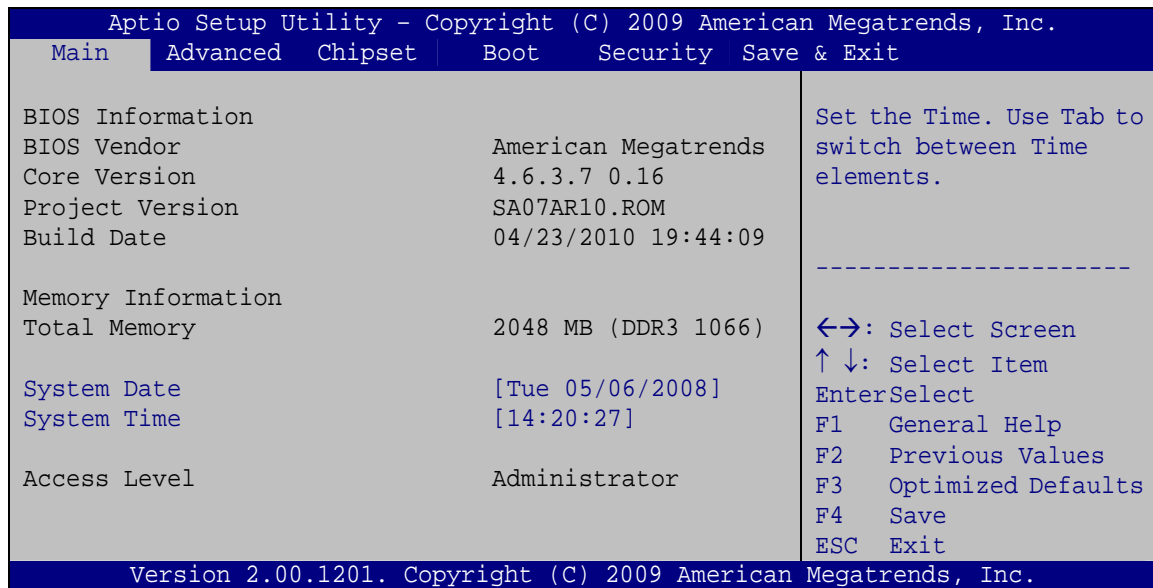

#### BIOS Menu 1: Main

##### → BIOS Information

The **BIOS Information** lists a brief summary of the BIOS. The fields in **BIOS Information** cannot be changed. The items shown in the system overview include:

- **BIOS Vendor:** Installed BIOS vendor
- **Core Version:** Current BIOS version
- **Project Version:** the board version
- **Build Date:** Date the current BIOS version was made

##### → Memory Information

The **Memory Information** lists a brief summary of the on-board memory. The fields in **Memory Information** cannot be changed.

- **Total Memory:** Displays the auto-detected system memory size and type.

The System Overview field also has two user configurable fields:

→ **System Date [xx/xx/xx]**

Use the **System Date** option to set the system date. Manually enter the day, month and year.

→ **System Time [xx:xx:xx]**

Use the **System Time** option to set the system time. Manually enter the hours, minutes and seconds.

### 5.3 Advanced

Use the **Advanced** menu (**BIOS Menu 2**) to configure the CPU and peripheral devices through the following sub-menus:



**WARNING!**

Setting the wrong values in the sections below may cause the system to malfunction. Make sure that the settings made are compatible with the hardware.

```

Aptio Setup Utility - Copyright (C) 2009 American Megatrends, Inc.
Main  Advanced  Chipset  Boot  Security  Save & Exit
-----
> ACPI Settings
> CPU Configuration
> SATA Configuration
> USB Configuration
> Super IO Configuration
> H/M Monitor
> AMT Configuration
> Serial Port Console Redirection

System ACPI Parameters
-----
<=>: Select Screen
↑ ↓: Select Item
Enter>Select
F1  General Help
F2  Previous Values
F3  Optimized
Defaults
F4  Save
ESC Exit

Version 2.00.1201. Copyright (C) 2009 American Megatrends, Inc.

```

**BIOS Menu 2: Advanced**

## NANO-QM57A EPIC SBC

### 5.3.1 ACPI Configuration

The **ACPI Configuration** menu (**BIOS Menu 3**) configures the Advanced Configuration and Power Interface (ACPI) options.

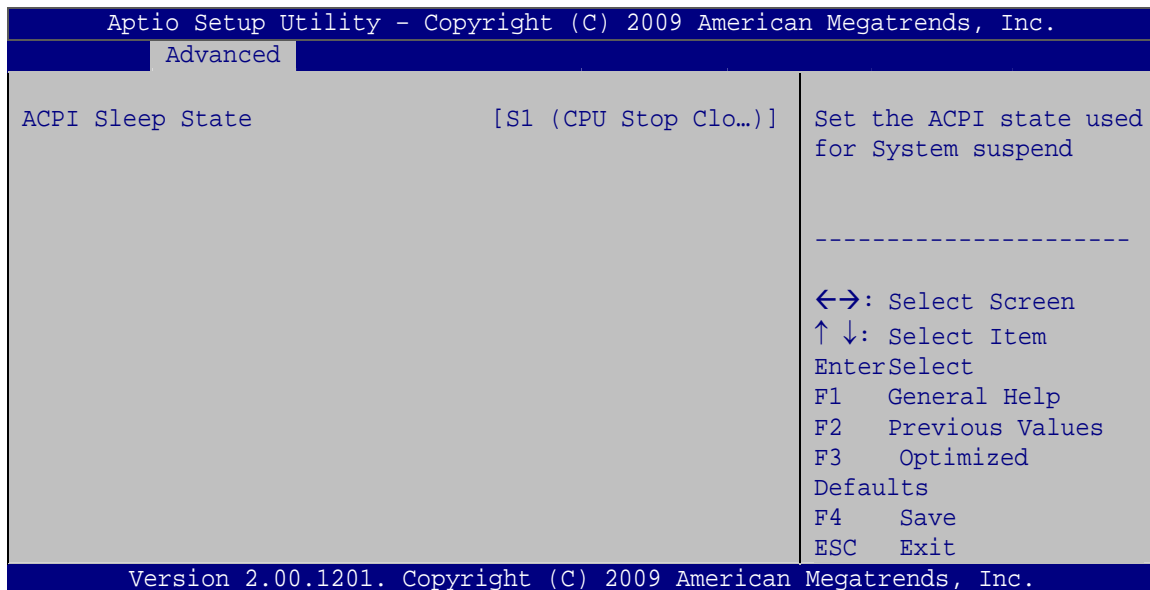

#### BIOS Menu 3: ACPI Configuration

##### → ACPI Sleep State [S1 (CPU Stop Clock)]

Use the **ACPI Sleep State** option to specify the sleep state the system enters when it is not being used.

- **S1 (CPU Stop DEFAULT Clock)** The system enters S1(POS) sleep state. The system appears off. The CPU is stopped; RAM is refreshed; the system is running in a low power mode.
- **S3 (Suspend to RAM)** The caches are flushed and the CPU is powered off. Power to the RAM is maintained. The computer returns slower to a working state, but more power is saved.



### 5.3.2 CPU Configuration

Use the **CPU Configuration** menu (**BIOS Menu 4**) to view detailed CPU specifications and configure the CPU.

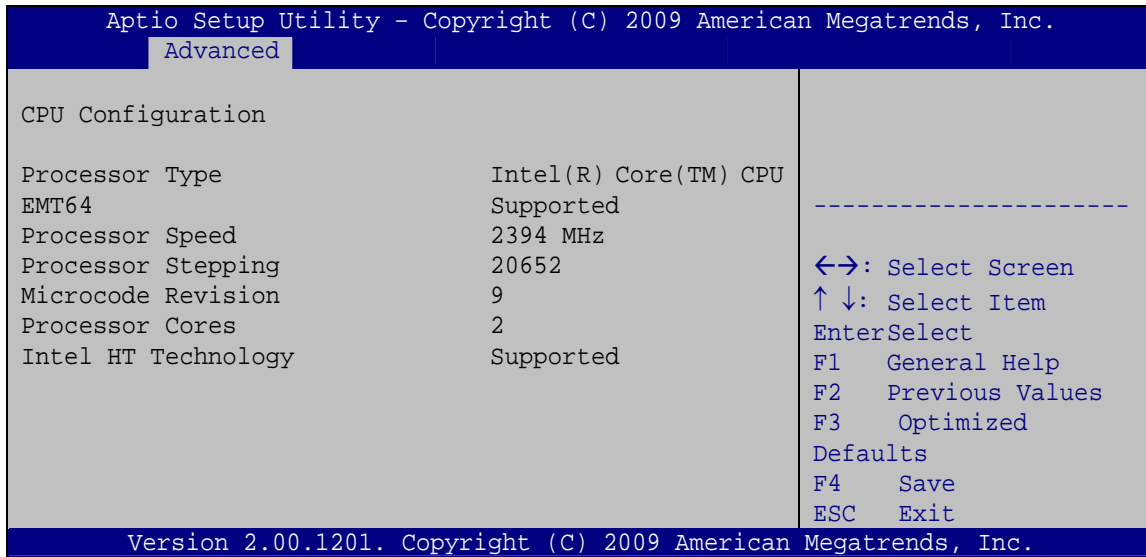

#### BIOS Menu 4: CPU Configuration

The CPU Configuration menu (**BIOS Menu 4**) lists the following CPU details:

- Processor Type: Lists the brand name of the CPU being used
- EMT64: Indicates if the EM64T is supported by the CPU.
- Processor Speed: Lists the CPU processing speed
- Processor Stepping: Lists the CPU processing stepping
- Microcode Revision: Lists the microcode revision
- Processor Cores: Lists the number of the processor core
- Intel HT Technology: Indicates if the Intel HT Technology is supported by the CPU.

## NANO-QM57A EPIC SBC

### 5.3.3 SATA Configuration

Use the **SATA Configuration** menu (**BIOS Menu 5**) to change and/or set the configuration of the SATA devices installed in the system.

```

Aptio Setup Utility - Copyright (C) 2009 American Megatrends, Inc.
  Advanced
SATA Configuration
SATA Port0          Not Present
SATA Port1          Not Present
SATA Port5          Not Present

SATA Mode           [IDE Mode]
Serial-ATA Controller 0 [Enhanced]
Serial-ATA Controller 1 [Enhanced]

(1) IDE Mode. (2) AHCI
Mode. (3) RAID Mode.

-----
<=>: Select Screen
↑ ↓: Select Item
Enter>Select
F1   General Help
F2   Previous Values
F3   Optimized
Defaults
F4   Save
ESC  Exit

Version 2.00.1201. Copyright (C) 2009 American Megatrends, Inc.
  
```

#### BIOS Menu 5: IDE Configuration

##### → SATA Mode [IDE Mode]

Use the **SATA Mode** option to configure SATA devices as normal IDE devices.

- **Disable**                      Disables SATA devices.
- **IDE Mode**      **DEFAULT**      Configures SATA devices as normal IDE device.
- **AHCI Mode**                      Configures SATA devices as AHCI device.
- **RAID Mode**                      Configures SATA devices as RAID device.

##### → Serial-ATA Controller 0/1 [Enhanced]

Use the **Serial-ATA Controller** option to configure the Serial-ATA controller mode when the SATA mode is set to IDE Mode.

- **Disable**                      Disables Serial-ATA controller.

- ➔ **Enhanced**     **DEFAULT**     Configures the Serial-ATA controller to be in enhanced mode. In this mode, IDE channels and SATA channels are separated. Some legacy OS do not support this mode.
  
- ➔ **Compatible**     Configures the Serial-ATA controller to be in compatible mode. In this mode, a SATA channel will replace one of the IDE channels.

### 5.3.4 USB Configuration

Use the **USB Configuration** menu (**BIOS Menu 6**) to read USB configuration information and configure the USB settings.

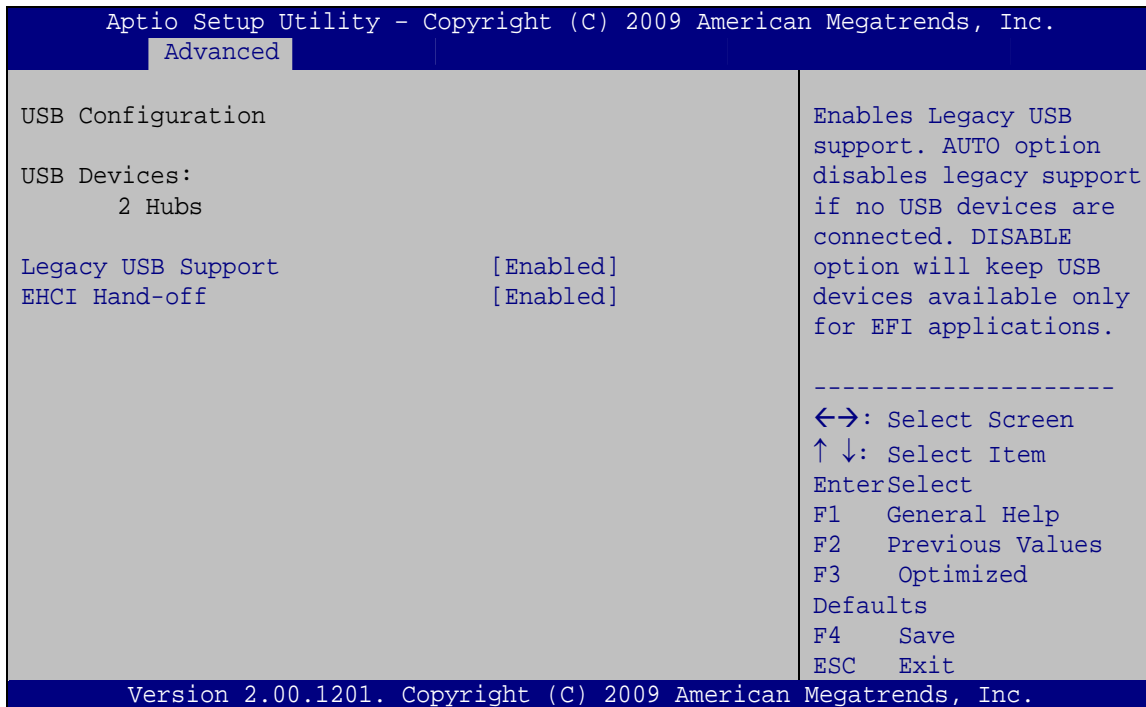

#### BIOS Menu 6: USB Configuration

##### ➔ USB Devices

The **USB Devices Enabled** field lists the USB devices that are enabled on the system

## NANO-QM57A EPIC SBC

### → All USB Devices [Enabled]

Use the **All USB Devices** option to enable the USB devices.

- **Disabled** All USB devices are disabled.
- **Enabled** **DEFAULT** All USB devices are enabled.

### → Legacy USB Support [Enabled]

Use the **Legacy USB Support** BIOS option to enable USB mouse and USB keyboard support. Normally if this option is not enabled, any attached USB mouse or USB keyboard does not become available until a USB compatible operating system is fully booted with all USB drivers loaded. When this option is enabled, any attached USB mouse or USB keyboard can control the system even when there is no USB driver loaded onto the system.

- **Disabled** Legacy USB support disabled
- **Enabled** **DEFAULT** Legacy USB support enabled
- **Auto** Legacy USB support disabled if no USB devices are connected

### 5.3.5 Super IO Configuration

Use the **Super IO Configuration** menu (**BIOS Menu 7**) to set or change the configurations for the FDD controllers, parallel ports and serial ports.

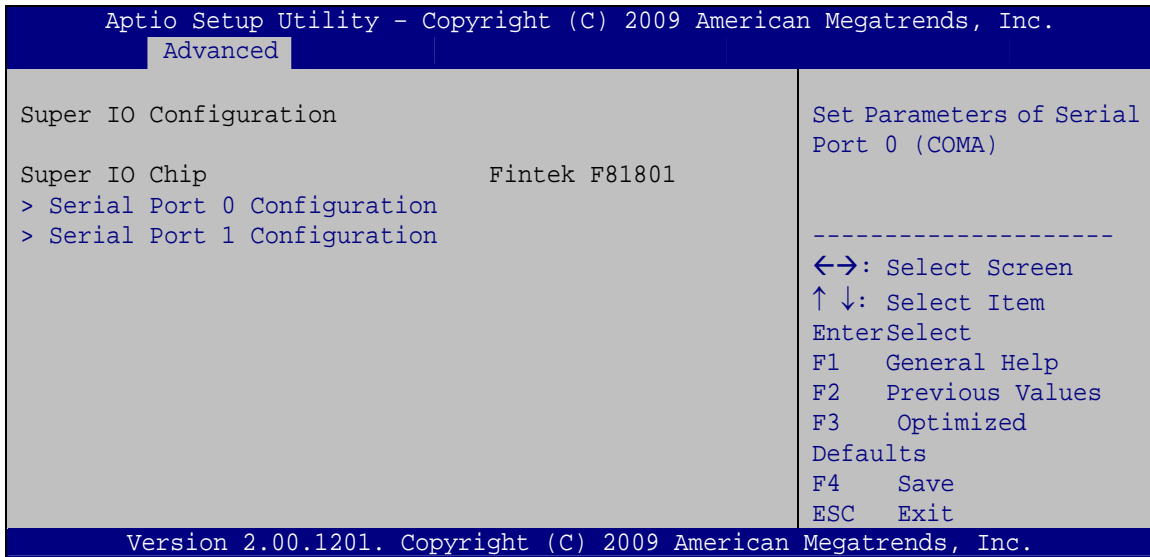

**BIOS Menu 7: Super IO Configuration**

#### 5.3.5.1 Serial Port n Configuration

Use the **Serial Port n Configuration** menu (**BIOS Menu 8**) to configure the serial port n.

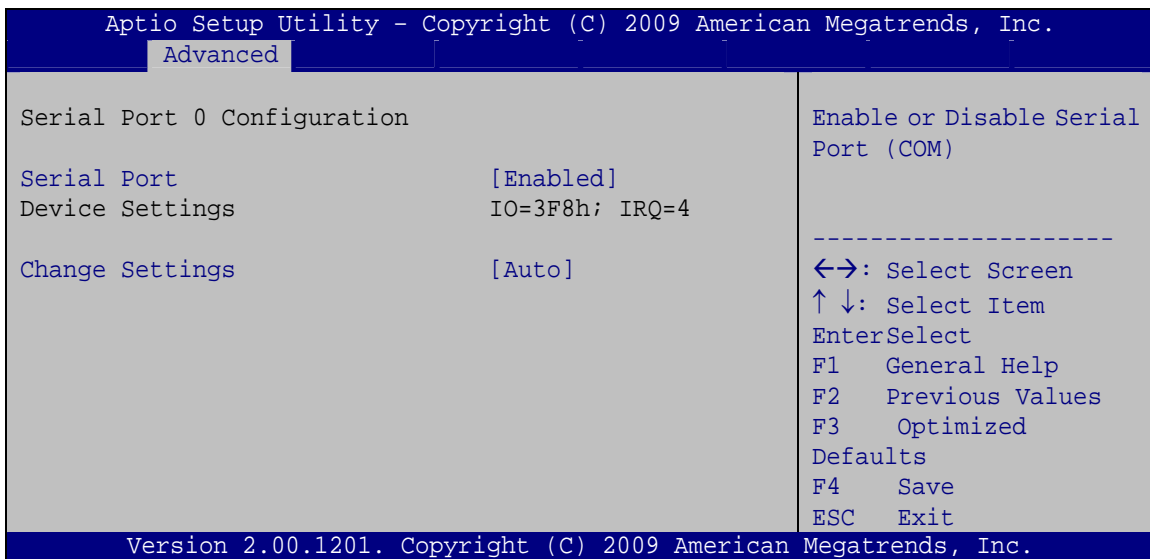

**BIOS Menu 8: Serial Port n Configuration Menu**



## NANO-QM57A EPIC SBC

### 5.3.5.1.1 Serial Port 0 Configuration

#### → Serial Port [Enabled]

Use the **Serial Port** option to enable or disable the serial port.

- **Disabled**                      Disable the serial port
- **Enabled**      **DEFAULT**      Enable the serial port

#### → Change Settings [Auto]

Use the **Change Settings** option to change the serial port IO port address and interrupt address.

- **Auto**              **DEFAULT**      The serial port IO port address and interrupt address are automatically detected.
- **IO=3F8h;**  
**IRQ=4**                      Serial Port I/O port address is 3F8h and the interrupt address is IRQ4
- **IO=3F8h;**  
**IRQ=3, 4,**  
**5, 6, 7, 9,**  
**10, 11, 12**                      Serial Port I/O port address is 3F8h and the interrupt address is IRQ3, 4, 5, 6, 7, 9, 10, 11, 12
- **IO=2F8h;**  
**IRQ=3, 4,**  
**5, 6, 7, 9,**  
**10, 11, 12**                      Serial Port I/O port address is 2F8h and the interrupt address is IRQ3, 4, 5, 6, 7, 9, 10, 11, 12
- **IO=3E8h;**  
**IRQ=3, 4,**  
**5, 6, 7, 9,**  
**10, 11, 12**                      Serial Port I/O port address is 3E8h and the interrupt address is IRQ3, 4, 5, 6, 7, 9, 10, 11, 12
- **IO=2E8h;**  
**IRQ=3, 4,**  
**5, 6, 7, 9,**  
**10, 11, 12**                      Serial Port I/O port address is 2E8h and the interrupt address is IRQ3, 4, 5, 6, 7, 9, 10, 11, 12

### 5.3.5.1.2 Serial Port 1 Configuration

#### → Serial Port [Enabled]

Use the **Serial Port** option to enable or disable the serial port.

- **Disabled**                      Disable the serial port
- **Enabled**      **DEFAULT**      Enable the serial port

#### → Change Settings [Auto]

Use the **Change Settings** option to change the serial port IO port address and interrupt address.

- **Auto**              **DEFAULT**      The serial port IO port address and interrupt address are automatically detected.
- **IO=2F8h;**  
**IRQ=3**                      Serial Port I/O port address is 2F8h and the interrupt address is IRQ3
- **IO=3F8h;**  
**IRQ=3, 4,**  
**5, 6, 7, 9,**  
**10, 11, 12**                      Serial Port I/O port address is 3F8h and the interrupt address is IRQ3, 4, 5, 6, 7, 9, 10, 11, 12
- **IO=2F8h;**  
**IRQ=3, 4,**  
**5, 6, 7, 9,**  
**10, 11, 12**                      Serial Port I/O port address is 2F8h and the interrupt address is IRQ3, 4, 5, 6, 7, 9, 10, 11, 12
- **IO=3E8h;**  
**IRQ=3, 4,**  
**5, 6, 7, 9,**  
**10, 11, 12**                      Serial Port I/O port address is 3E8h and the interrupt address is IRQ3, 4, 5, 6, 7, 9, 10, 11, 12
- **IO=2E8h;**  
**IRQ=3, 4,**  
**5, 6, 7, 9,**  
**10, 11, 12**                      Serial Port I/O port address is 2E8h and the interrupt address is IRQ3, 4, 5, 6, 7, 9, 10, 11, 12

## NANO-QM57A EPIC SBC

### 5.3.6 H/W Monitor

The H/W Monitor menu (**BIOS Menu 9**) shows the operating temperature, fan speeds and system voltages.

```

Aptio Setup Utility - Copyright (C) 2009 American Megatrends, Inc.
  Advanced
PC Health Status
> Smart Fan Mode Configuration

CPU Temperature      :+53 C
SYS Temperature     :+29 C

CPU FAN Speed       :4702 RPM
SYS FAN Speed       :N/A

VIN0 (VCC3C)        :+3.296 V
VIN1 (VCORE)        :+1.056 V
VIN2 (+1.5V)        :+1.512 V
VSB3V               :+3.312 V
VBAT                :+3.184 V

-----
<->: Select Screen
↑ ↓: Select Item
Enter>Select
F1   General Help
F2   Previous Values
F3   Optimized
Defaults
F4   Save
ESC  Exit

Version 2.00.1201. Copyright (C) 2009 American Megatrends, Inc.
  
```

#### BIOS Menu 9: Hardware Health Configuration

##### → Smart Fan Mode Configuration [Auto Fan by RPM]

Use the **Smart Fan Mode Configuration** option to configure the CPU fan.

- **Auto RPM Mode**      **DEFAULT**      The fan adjusts its speed using these settings by RPM:
  - First Boundary Temperature
  - Second Boundary Temperature
  - Third Boundary Temperature
  - Fourth Boundary Temperature
  - Segment 1 Speed Count
  - Segment 2 Speed Count
  - Segment 3 Speed Count
  - Segment 4 Speed Count
  - Segment 5 Speed Count
  - Starting Full Speed Count
  
- **Auto Duty Cycle Mode**      The fan adjusts its speed using these settings by Duty Cycle:
  - First Boundary Temperature
  - Second Boundary Temperature
  - Third Boundary Temperature
  - Fourth Boundary Temperature
  - Segment 1 Speed Count
  - Segment 2 Speed Count
  - Segment 3 Speed Count
  - Segment 4 Speed Count
  - Segment 5 Speed Count
  
- **Manual RPM Mode**      The fan spins at the speed set in:
  - Expect speed count value
  - (Min=1000 rpm, Max=15000 rpm)
  
- **Manual Duty Cycle Mode**      The fan spins at the speed set in:
  - Expect Duty Cycle
  - (Min=0%, Max=100%)

## NANO-QM57A EPIC SBC



### NOTE:

Smart fan functions are supported only when using a 4-pin fan. When using a 3-pin fan, the functions are not supported.

### → First Boundary Temperature [060]



### WARNING:

CPU failure can result if this value is set too high

When the fan is off, it will only start when the temperature exceeds this setting.

- Minimum Value: 1°C
- Maximum Value: 128°C

### → Second Boundary Temperature [050]



### WARNING:

CPU failure can result if this value is set too high

When the fan is off, it will only start when the temperature exceeds this setting.

- Minimum Value: 1°C
- Maximum Value: 128°C

### → Third Boundary Temperature [040]



### WARNING:

CPU failure can result if this value is set too high



When the fan is off, it will only start when the temperature exceeds this setting.

- Minimum Value: 1°C
- Maximum Value: 128°C

→ **Fourth Boundary Temperature [030]**

---



**WARNING:**

CPU failure can result if this value is set too high

---

When the fan is off, it will only start when the temperature exceeds this setting.

- Minimum Value: 1°C
- Maximum Value: 128°C

→ **Segment 1 Speed Count [100]**

This value is always full speed and corresponds to the First Boundary Temperature. This speed should be higher than Segment 2.

- Minimum Value: 1%
- Maximum Value: 100%

→ **Segment 2 Speed Count [085]**

This value is always full speed and corresponds to the Boundary Temperature. This speed should be higher than Segment 3.

- Minimum Value: 1%
- Maximum Value: 100%

→ **Segment 3 Speed Count [070]**

This value is always full speed and corresponds to the Third Boundary Temperature. This speed should be higher than Segment 4.

- Minimum Value: 1%

## NANO-QM57A EPIC SBC

- Maximum Value: 100%

### → Segment 4 Speed Count [060]

This value is always full speed and corresponds to the Fourth Boundary Temperature. This speed should be higher than Segment 5.

- Minimum Value: 1%
- Maximum Value: 100%

### → Segment 5 Speed Count [050]

This value is always full speed. The CPU fan starts at this speed.

- Minimum Value: 1%
- Maximum Value: 100%

### → Starting Full Speed Count

This value is the starting speed of the CPU fan.

- Minimum Value: 1000 RPM
- Maximum Value: 15000 RPM

### → PC Health Status

The following system parameters and values are shown. The system parameters that are monitored are:

- System Temperatures:
  - CPU Temperature
  - System Temperature
- Fan Speeds:
  - CPU Fan Speed
  - System Fan Speed
- Voltages:
  - VCC3V
  - Vcore
  - +5V

- +12 V
- +1.5V
- VSB3V
- VBAT

### 5.3.7 AMT Configuration

The **AMT Configuration** menu (**BIOS Menu 10**) allows the advanced power management options to be configured.

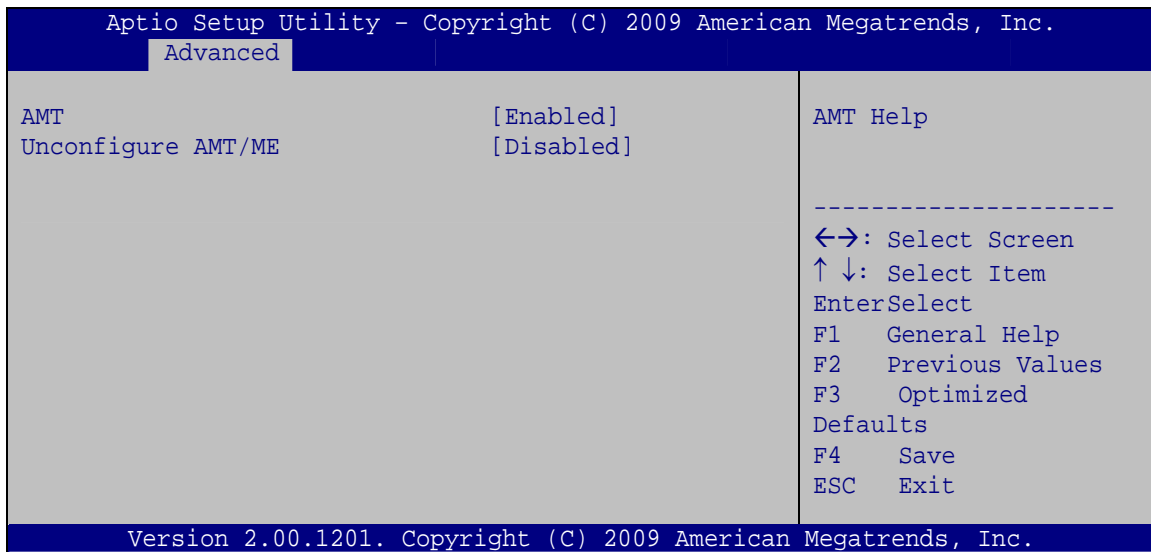

#### BIOS Menu 10: AMT Configuration

##### → AMT [Enabled]

Use **AMT** option to enable or disable the Intel® AMT function.

- **Disabled** Intel® AMT is disabled
- **Enabled** **DEFAULT** Intel® AMT is enabled

##### → Unconfigure AMT/ME [Disabled]

Use the **Unconfigure AMT/ME** option to perform AMT/ME unconfigure without password operation.

## NANO-QM57A EPIC SBC

- ➔ **Disabled**      **DEFAULT**      Not perform AMT/ME unconfigure
- ➔ **Enabled**                      To perform AMT/ME unconfigure

### 5.3.8 Serial Port Console Redirection

The **Serial Port Console Redirection** menu (**BIOS Menu 11**) allows the console redirection options to be configured. Console redirection allows users to maintain a system remotely by re-directing keyboard input and text output through the serial port.

```

Aptio Setup Utility - Copyright (C) 2009 American Megatrends, Inc.
  Advanced
-----
COM0
  Console Redirection                      [Enabled]
> Console Redirection Settings

COM1
  Console Redirection                      [Disabled]
> Console Redirection Settings

-----
<=>: Select Screen
↑↓: Select Item
Enter>Select
F1    General Help
F2    Previous Values
F3    Optimized
      Defaults
F4    Save
ESC   Exit

Version 2.00.1201. Copyright (C) 2009 American Megatrends, Inc.
  
```

#### BIOS Menu 11: Serial Port Console Redirection

##### ➔ Console Redirection

Use **Console Redirection** option to enable or disable the console redirection function.

- ➔ **Disabled**                      Disabled the console redirection function
- ➔ **Enabled**                      Enabled the console redirection function

### 5.3.8.1 Console Redirection Settings

The **Console Redirection Settings** menu (**BIOS Menu 12**) allows the console redirection options to be configured. The option is active when Console Redirection option is enabled.

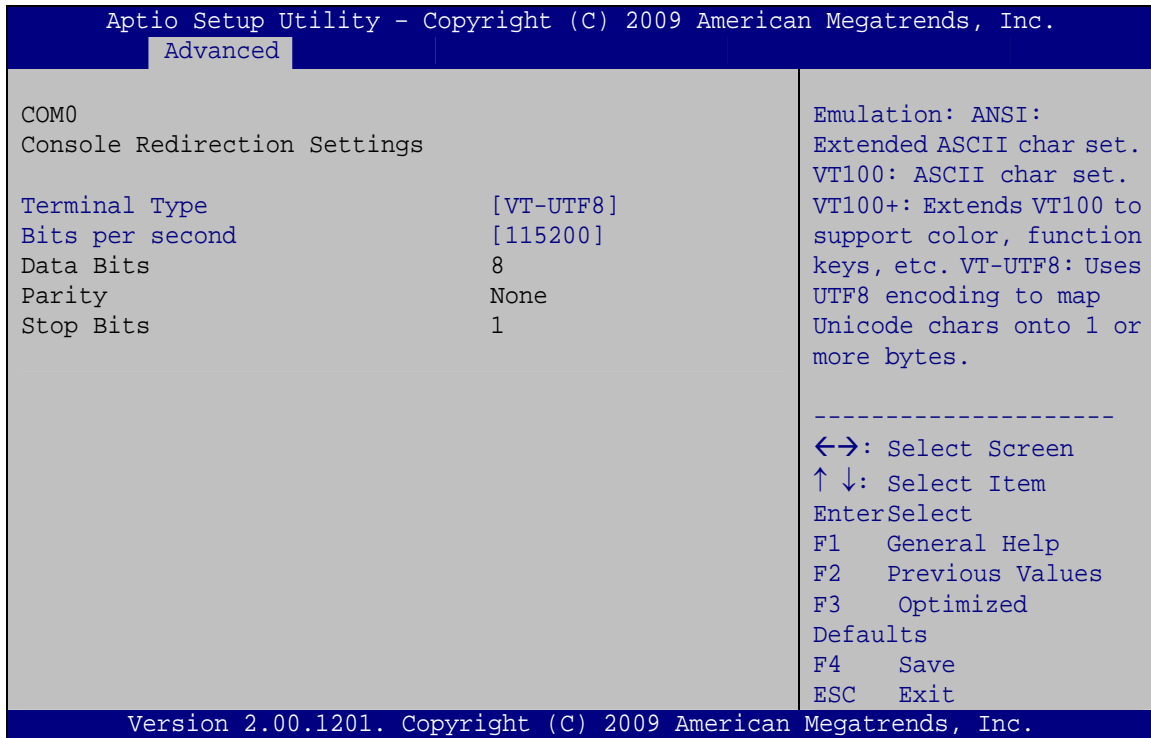

#### BIOS Menu 12: Console Redirection Settings

##### → Terminal Type [ANSI]

Use the **Terminal Type** option to specify the remote terminal type..

- **VT100**                      The target terminal type is VT100
- **VT100+**                    The target terminal type is VT100+
- **VT-UTF8**                    The target terminal type is VT-UTF8
- **ANSI**                      **DEFAULT**                    The target terminal type is ANSI

##### → Bits per second [115200]

Use the **Bits per second** option to specify the transmission speed of the serial port.



## NANO-QM57A EPIC SBC

- 9600                      The transmission speed is 9600
- 19200                    The transmission speed is 19200
- 57600                    The transmission speed is 57600
- 115200                  **DEFAULT**                  The transmission speed is 115200

### 5.4 Chipset

Use the **Chipset** menu (**BIOS Menu 13**) to access the Northbridge and Southbridge configuration menus



#### **WARNING!**

Setting the wrong values for the Chipset BIOS selections in the Chipset BIOS menu may cause the system to malfunction.

```

Aptio Setup Utility - Copyright (C) 2009 American Megatrends, Inc.
Main   Advanced  Chipset  Boot   Security  Save & Exit
-----
> North Bridge
> South Bridge
> Integrated Graphics

North Bridge Parameters
-----
<=>: Select Screen
↑↓: Select Item
Enter>Select
F1   General Help
F2   Previous Values
F3   Optimized
Defaults
F4   Save
ESC  Exit

Version 2.00.1201. Copyright (C) 2009 American Megatrends, Inc.
  
```

**BIOS Menu 13: Chipset**

### 5.4.1 Northbridge Configuration

Use the **Northbridge Chipset Configuration** menu (**BIOS Menu 14**) to configure the Northbridge chipset.

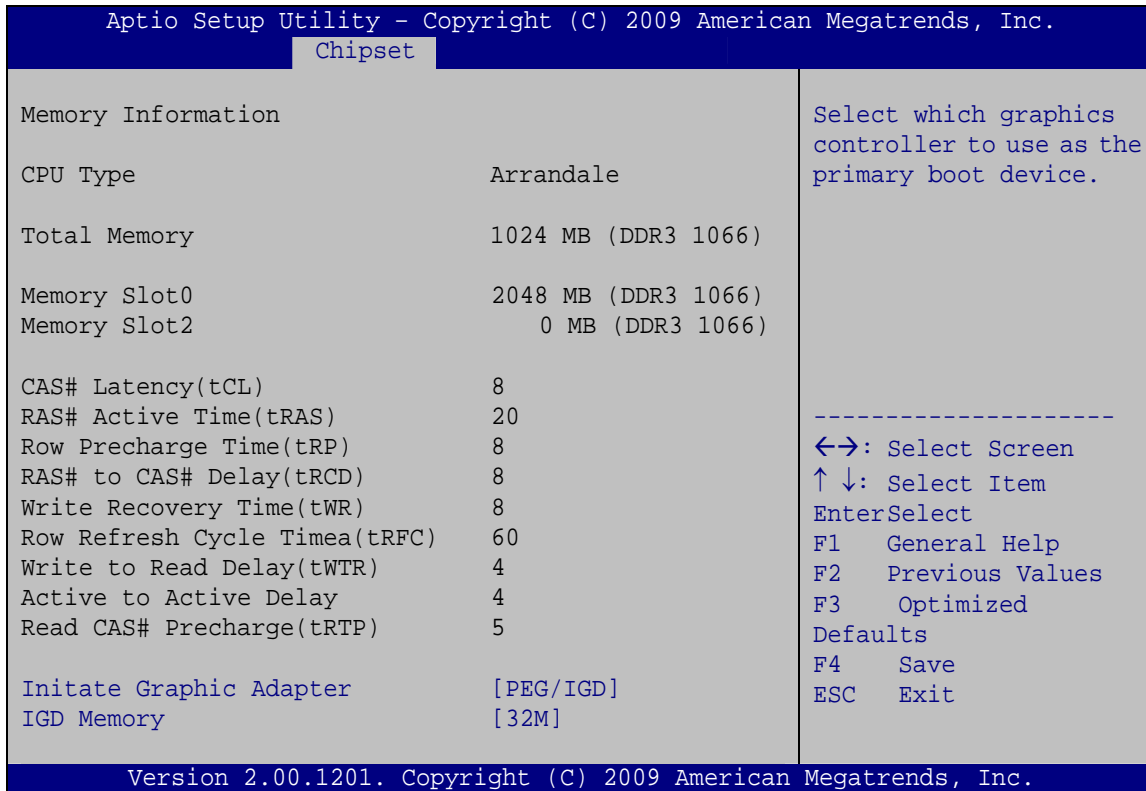

#### BIOS Menu 14:Northbridge Chipset Configuration

##### → Initiate Graphics Adapter [PEG/IGD]

Use the **Initiate Graphics Adapter** option to select the graphics controller used as the primary boot device. Select either an integrated graphics controller (IGD) or a combination of PCI graphics controller, a PCI express (PEG) controller or an IGD. Configuration options are listed below:

- IGD
- PEG/IGD      **DEFAULT**

## NANO-QM57A EPIC SBC

### → IGD Memory [32 MB]

Use the **IGD Memory** option to specify the amount of system memory that can be used by the Internal graphics device.

- **Disable**
- **32 MB**                      **DEFAULT**      32 MB of memory used by internal graphics device
- **64 MB**    64 MB of memory used by internal graphics device
- **128 MB**     128 MB of memory used by internal graphics device

## 5.4.2 Southbridge Configuration

Use the **Southbridge Configuration** menu (**BIOS Menu 15**) to configure the Southbridge chipset.

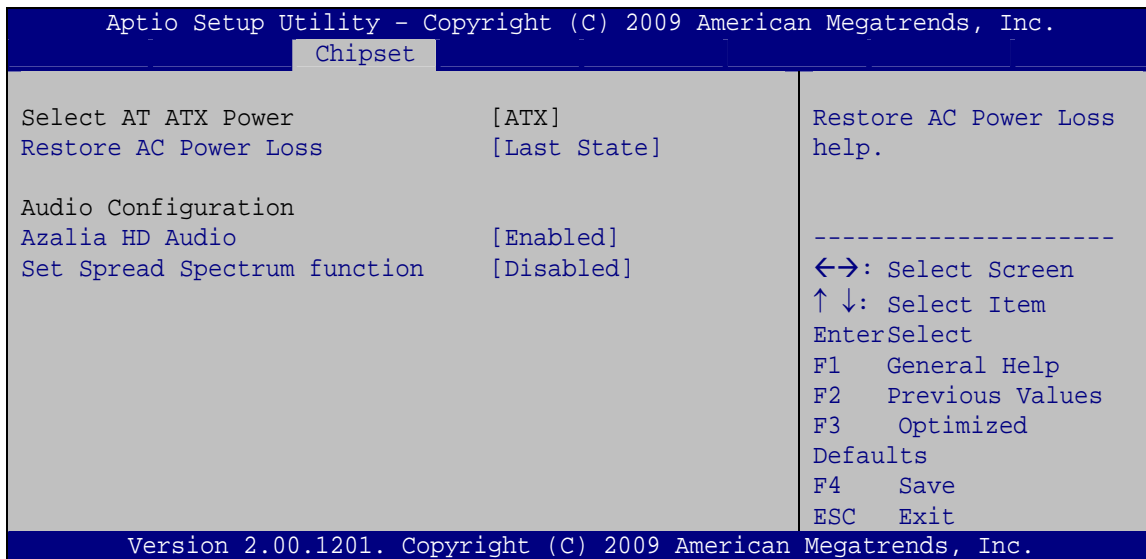

### BIOS Menu 15:Southbridge Chipset Configuration

### → Restore AC Power Loss [Power Off]

Use the **Restore on AC Power Loss** BIOS option to specify what state the system returns to if there is a sudden loss of power to the system.

- **Power Off**    The system remains turned off

- **Power On**    **DEFAULT**    The system turns on
- **Last State**                      The system returns to its previous state. If it was on, it turns itself on. If it was off, it remains off.

→ **Azalia HD Audio [Enabled]**

Use the **Azalia HD Audio** option to enable or disable the High Definition Audio controller.

- **Disabled**                      The onboard High Definition Audio controller is disabled
- **Enabled**    **DEFAULT**    The onboard High Definition Audio controller automatically detected and enabled

→ **Set Spread Spectrum function [Disabled]**

Use the **Set Spread Spectrum function** option to reduce the EMI. Excess EMI is generated when the system clock generator pulses have extreme values. Spreading the pulse spectrum modulates changes in the extreme values from spikes to flat curves, thus reducing the EMI. This benefit may in some cases be outweighed by problems with timing-critical devices, such as a clock-sensitive SCSI device.

- **Disabled**    **DEFAULT**    EMI not reduced
- **Enabled**                      EMI reduced

## NANO-QM57A EPIC SBC

### 5.4.3 Integrated Graphics

Use the **Integrated Graphics** menu to configure the video device connected to the system.

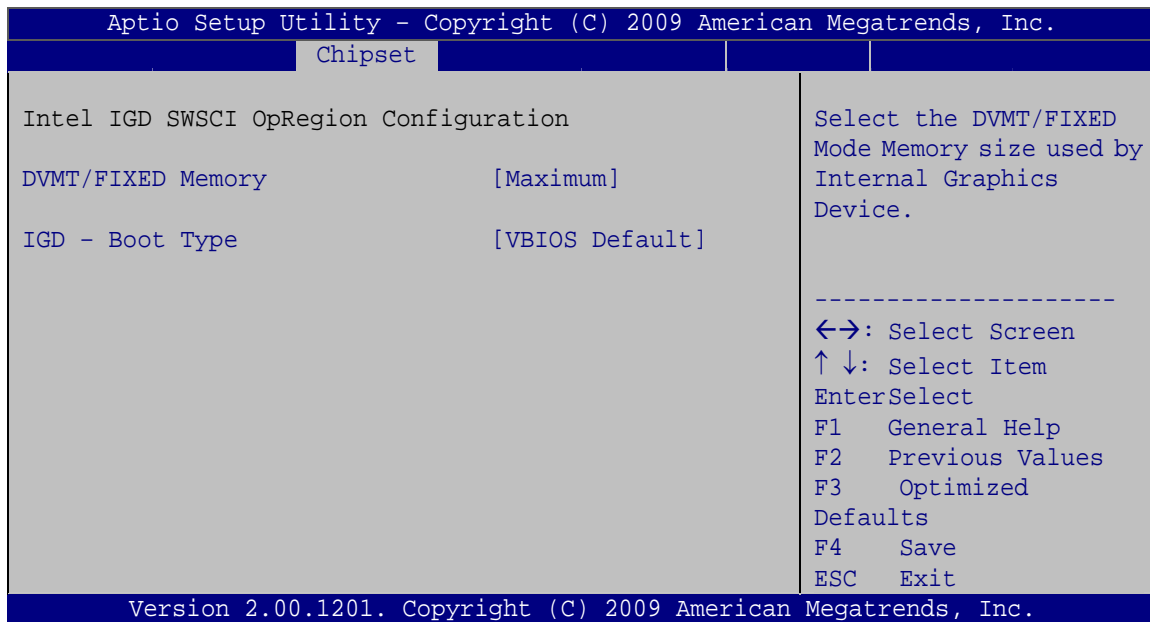

#### BIOS Menu 16: Intel IGD SWSCI OpRegion

##### → DVMT/FIXED Memory [128 MB]

Use the **DVMT/FIXED Memory** option to specify the maximum amount of memory that can be allocated as graphics memory. Configuration options are listed below.

- 128 MB            Default
- 256 MB
- Maximum

##### → IGD – Boot Type [VBIOS Default]

Use the **IGD – Boot Type** BIOS feature to determine what displays are used. Dual display functionality is enabled here. Dual display configuration options are listed below:

- VBIOS Default    DEFAULT
- CRT
- CTR1



- EFP
- EFP1
- CRT + CRT1
- CRT + EFP1

## 5.5 Boot

Use the **Boot** menu (**BIOS Menu 17**) to configure system boot options.

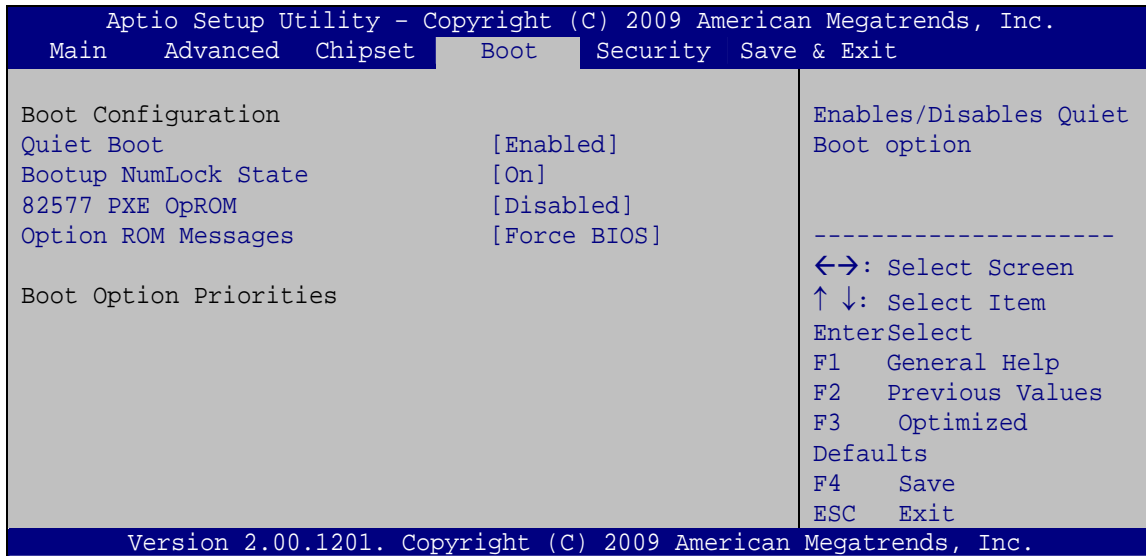

### BIOS Menu 17: Boot

#### → Quiet Boot [Enabled]

Use the **Quiet Boot** BIOS option to select the screen display when the system boots.

- **Disabled**                      Normal POST messages displayed
- **Enabled**                      **DEFAULT**      OEM Logo displayed instead of POST messages

#### → Bootup NumLock [On]

Use the **Bootup NumLock** BIOS option to specify if the number lock setting must be modified during boot up.

## NANO-QM57A EPIC SBC

- ➔ **Off** Does not enable the keyboard Number Lock automatically. To use the 10-keys on the keyboard, press the Number Lock key located on the upper left-hand corner of the 10-key pad. The Number Lock LED on the keyboard lights up when the Number Lock is engaged.
- ➔ **On DEFAULT** Allows the Number Lock on the keyboard to be enabled automatically when the computer system boots up. This allows the immediate use of the 10-key numeric keypad located on the right side of the keyboard. To confirm this, the Number Lock LED light on the keyboard is lit.

### ➔ **82577 PXE OpROM [Disabled]**

Use the **82577 PXE OpROM** option to enable the Intel® 82577 PCIe GbE controller to boot the system.

- ➔ **Disabled DEFAULT** Cannot be booted from a remote system through the Intel® 82577 PCIe GbE controller
- ➔ **Enabled** Can be booted from a remote system through the Intel® 82577 PCIe GbE controller

### ➔ **Option ROM Messages [Force BIOS]**

Use the **Option ROM Messages** option to allow add-on ROM (read-only memory) messages to be displayed.

- ➔ **Force BIOS DEFAULT** The system forces third party BIOS to display during system boot.
- ➔ **Keep Current** The system displays normal information during system boot.

## 5.6 Security

Use the **Security** menu (**BIOS Menu 18**) to set system and user passwords.

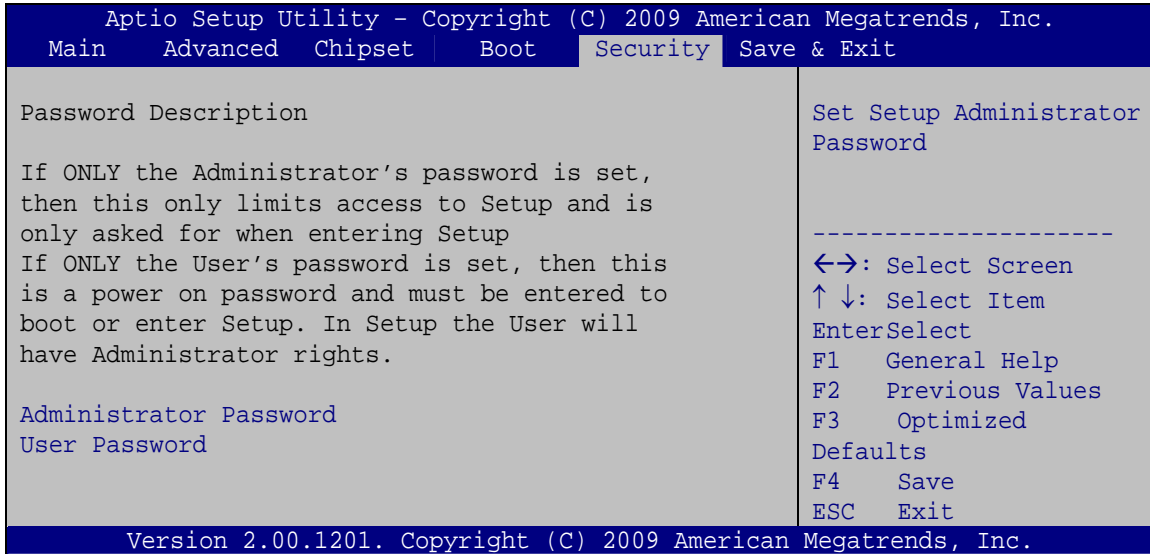

### BIOS Menu 18: Security

#### → Administrator Password

Use the **Administrator Password** to set or change a administrator password.

#### → User Password

Use the **User Password** to set or change a user password.

## NANO-QM57A EPIC SBC

### 5.7 Exit

Use the **Exit** menu (**BIOS Menu 19**) to load default BIOS values, optimal failsafe values and to save configuration changes.

```

Aptio Setup Utility - Copyright (C) 2009 American Megatrends, Inc.
Main   Advanced  Chipset  Boot   Security  Save & Exit
-----
Save Changes and Reset
Discard Changes and Reset

Save Options
Save Changes
Discard Changes

Restore Defaults

Exit system setup after
saving the changes.

-----
<->: Select Screen
↑ ↓: Select Item
Enter>Select
F1   General Help
F2   Previous Values
F3   Optimized
Defaults
F4   Save
ESC  Exit

Version 2.00.1201. Copyright (C) 2009 American Megatrends, Inc.
  
```

#### BIOS Menu 19:Exit

##### → Save Changes and Reset

Use the **Save Changes and Reset** option to save the changes made to the BIOS options and to exit the BIOS configuration setup program.

##### → Discard Changes and Reset

Use the **Discard Changes and Reset** option to exit the system without saving the changes made to the BIOS configuration setup program.

##### → Save Changes

Use the **Save Changes** option to save the changes made to the BIOS options.

→ **Discard Changes**

Use the **Discard Changes** option to discard the changes and remain in the BIOS configuration setup program.

→ **Restore Defaults**

Use the **Restore Defaults** option to load the optimal default values for each of the parameters on the Setup menus. **F3 key can be used for this operation.**



Appendix

A

# Intel<sup>®</sup> AMT Configuration

---

## A.1 Intel® AMT Setup Procedure

The NANO-QM57A is featured with the Intel® Active Management Technology (AMT) 6.0. To enable the Intel® AMT function, follow the steps below.

- Step 1:** Make sure the DIMM1 socket is installed with one DDR3 SO-DIMM.
- Step 2:** Connect an Ethernet cable to the RJ-45 connector labeled LAN2\_USB2.
- Step 3:** The AMI BIOS options regarding the Intel® ME or Intel® AMT must be enabled, including:
  - AMT Configuration [Advanced]
  - ME Subsystem [Chipset]
- Step 4:** Configure the Intel® Management Engine BIOS extension (MEBx) (see Section A.2 below)
- Step 5:** The following dialog window is displayed after the OS is loaded to show the Intel® AMT status on the NANO-QM57A is enabled.



Figure A-1: Intel® Active Management Technology Status Dialog

## A.2 Intel® Management Engine BIOS Extension

This section describes the essential steps for using the Intel® Management Engine BIOS extension (MEBx).

- Step 1:** A screen prompts the user to press <Ctrl+P> after a single beep during boot-up process. To get into the Intel® MEBx settings, press <Ctrl+P>.

## NANO-QM57A EPIC SBC

**Step 2:** Enter the Intel® ME password as it requires (**Figure A-2**). Enter the Intel® default password: **admin**.

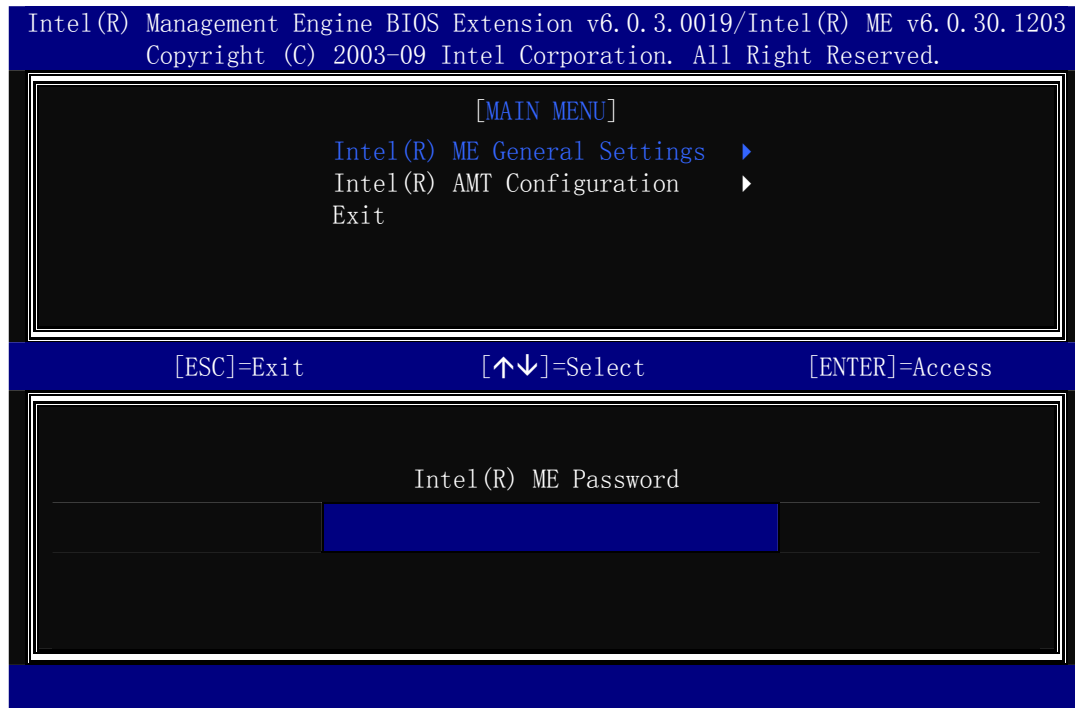

**Figure A-2: Intel® Current ME Password**

**Step 3:** Enter a new password following the strong password rule (containing at least one upper case letter, one lower case letter, one digit and one special character, and be at least eight characters). (**Figure A-3**)

**Step 4:** Verify the new password by entering again.

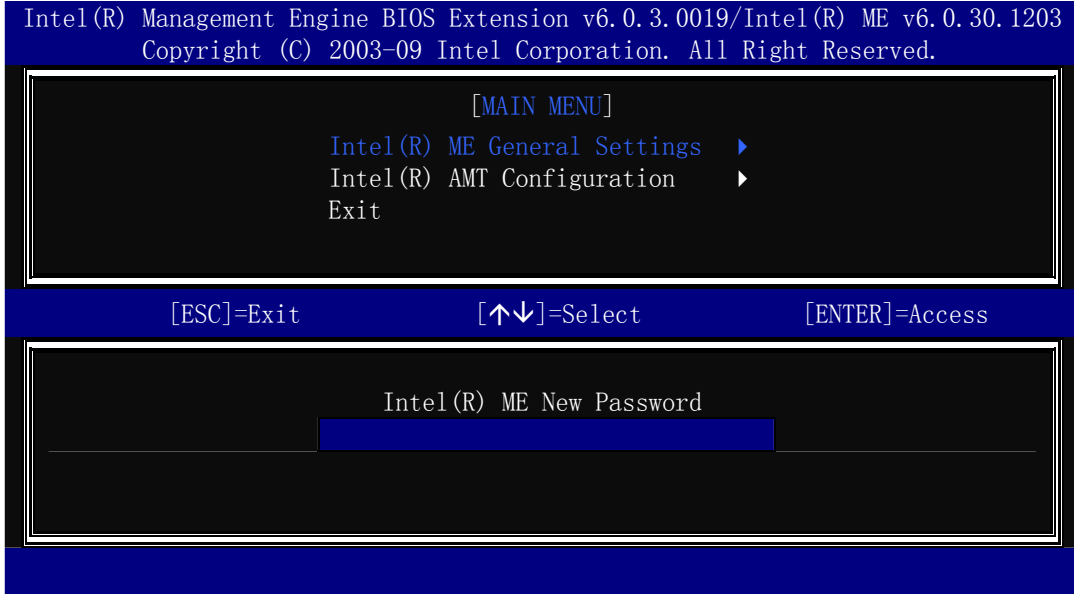

Figure A-3: Intel® ME New Password

**Step 5:** Select Intel® AMT Configuration and press Enter (Figure A-4).

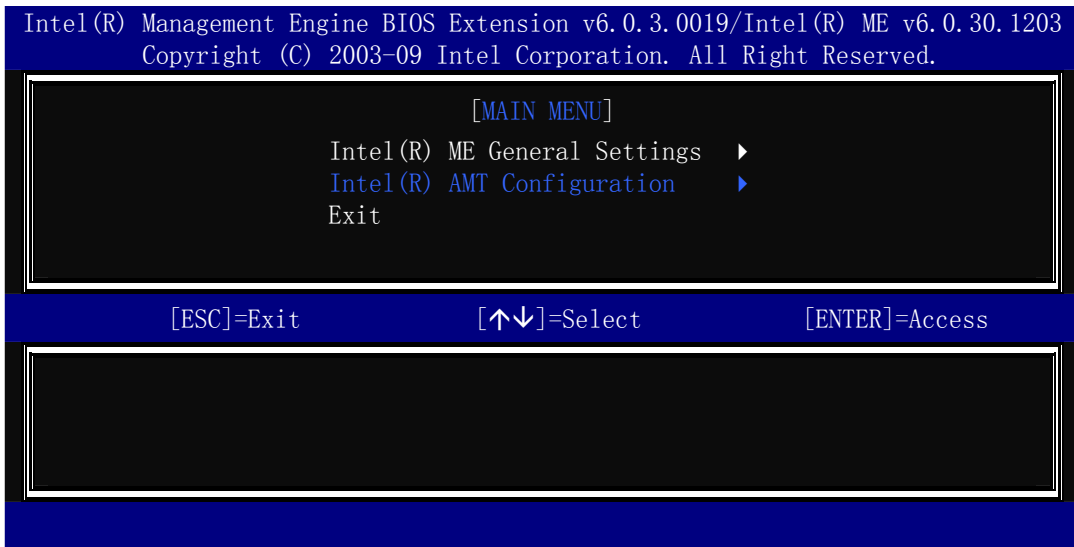
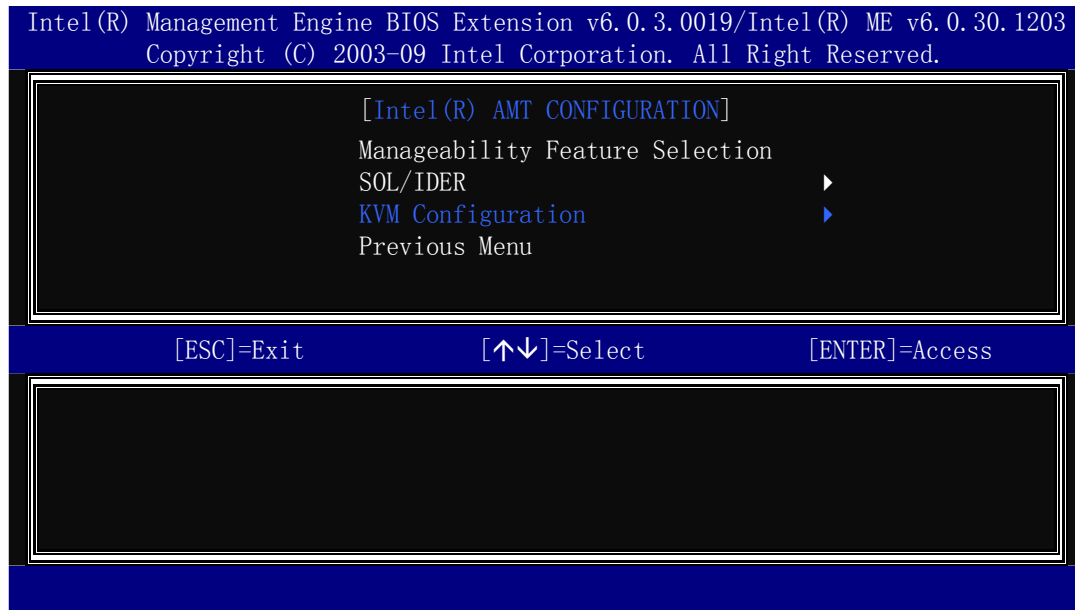

Figure A-4: Intel® AMT Configuration

**Step 6:** Select **KVM Configuration** and press **Enter**. (Figure A-5)



**Figure A-5: Select KVM Configuration**

**Step 7:** When the screen in **Figure A-6** prompts, select **User Opt-in** and press **Enter**.

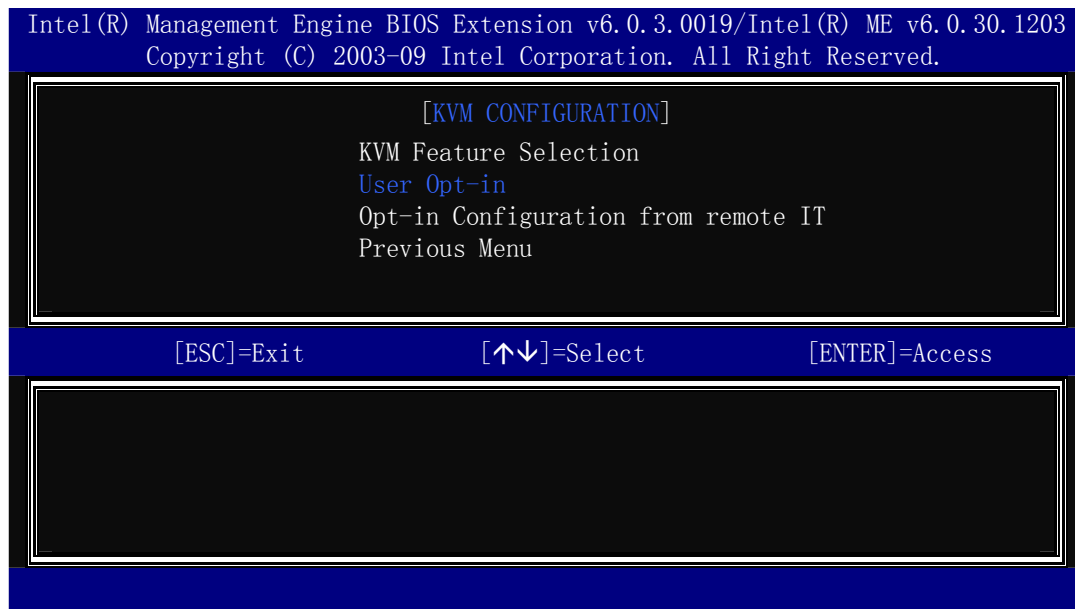

**Figure A-6: KVM Configuration**



**Step 8:** Two options are shown as in **Figure A-7**. Choose **User Consent is not required for KVM session** which means no password is required for using iAMT function. Then press **Enter**.

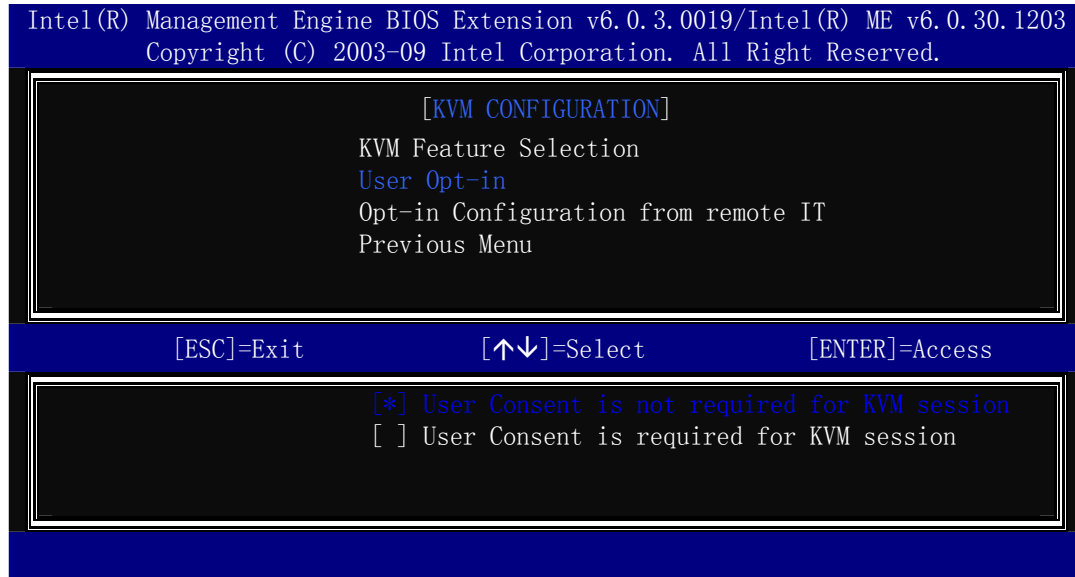

**Figure A-7: KVM User Opt-in**

**Step 9:** Make other necessary settings in the Intel® MEBx depending on users' need.

**Step 10:** To exit the Intel® MEBx, return to the main menu and select Exit. (**Figure A-8**)

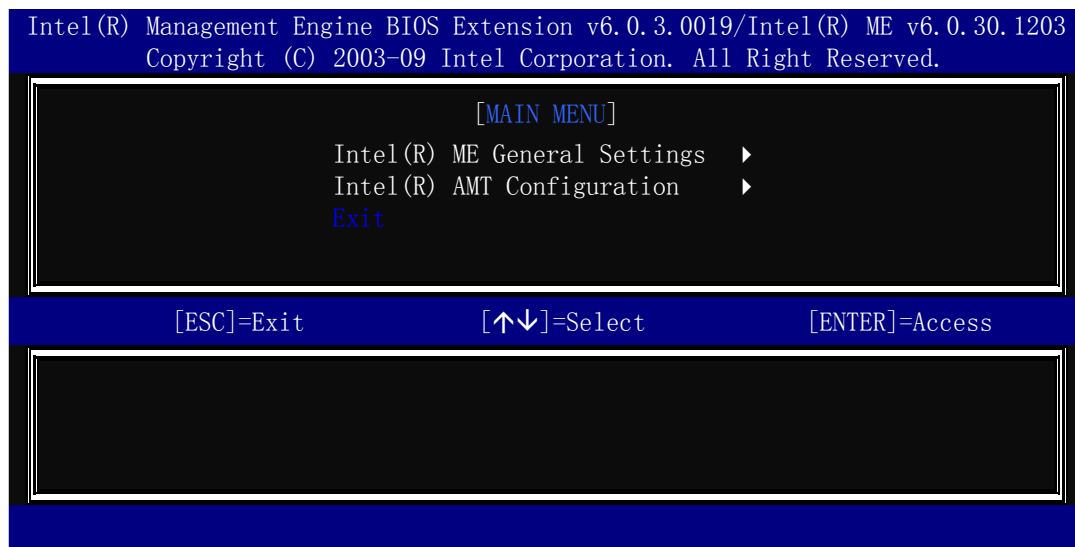

**Figure A-8: Exit**

### A.3 IEI Easy Manager Application



IEI Easy Manager (iEZMan) application program allows a remote user, such as a support person, to remotely control and perform administrative tasks through a graphical user interface in Windows. The functions of the iEZMan application include

- Power Management
- Schedule Power Management
- Remote Access
- Group Management
- Patch Management
- Alert and Events

For more information regarding the iEZMan application, please refer to the instruction manual of the iEZMan.

## Appendix

## B

# BIOS Menu Options

---

BIOS Information .....	59
Memory Information .....	59
System Date [xx/xx/xx] .....	60
System Time [xx:xx:xx] .....	60
ACPI Sleep State [S1 (CPU Stop Clock)] .....	61
SATA Mode [IDE Mode] .....	63
Serial-ATA Controller 0/1 [Enhanced] .....	63
USB Devices .....	64
All USB Devices [Enabled] .....	65
Legacy USB Support [Enabled] .....	65
Serial Port [Enabled] .....	67
Change Settings [Auto] .....	67
Serial Port [Enabled] .....	68
Change Settings [Auto] .....	68
Smart Fan Mode Configuration [Auto Fan by RPM] .....	69
First Boundary Temperature [060] .....	71
Second Boundary Temperature [050] .....	71
Third Boundary Temperature [040] .....	71
Fourth Boundary Temperature [030] .....	72
Segment 1 Speed Count [100] .....	72

## NANO-QM57A EPIC SBC

Segment 2 Speed Count [085] .....	72
Segment 3 Speed Count [070] .....	72
Segment 4 Speed Count [060] .....	73
Segment 5 Speed Count [050] .....	73
Starting Full Speed Count.....	73
PC Health Status .....	73
AMT [Enabled].....	74
Unconfigure AMT/ME [Disabled] .....	74
Console Redirection .....	75
Terminal Type [ANSI].....	76
Bits per second [115200].....	76
Initiate Graphics Adapter [PEG/IGD].....	78
IGD Memory [32 MB].....	79
Restore AC Power Loss [Power Off].....	79
Azalia HD Audio [Enabled].....	80
Set Spread Spectrum function [Disabled].....	80
DVMT/FIXED Memory [128 MB] .....	81
IGD – Boot Type [VBIOS Default].....	81
Quiet Boot [Enabled] .....	82
Bootup NumLock [On].....	82
82577 PXE OpROM [Disabled].....	83
Option ROM Messages [Force BIOS].....	83
Administrator Password .....	84
User Password .....	84
Save Changes and Reset .....	85
Discard Changes and Reset .....	85
Save Changes .....	85
Discard Changes.....	86
Restore Defaults .....	86

Appendix

**C**

# One Key Recovery

---



## C.1 One Key Recovery Introduction

The IEI one key recovery is an easy-to-use front end for the Norton Ghost system backup and recovery tool. The one key recovery provides quick and easy shortcuts for creating a backup and reverting to that backup or for reverting to the factory default settings.

To create the system backup the main storage device must be split into two partitions (three partitions for Linux). The first partition will be for the operating system, while the second partition will be invisible to the operating system and contain the backup made by the one key recovery software.

### C.1.1 System Requirement

The partition created for recovery images must be big enough to contain both the factory default image and the user backup image. The size must be calculated before creating the partitions. Please take the following table as a reference when calculating the size of the partition.

	OS	OS Image after Ghost	Compression Ratio
<b>Windows® 7</b>	7 GB	5 GB	70%
<b>Windows® XPE</b>	776 MB	560 MB	70%
<b>Windows® CE 6.0</b>	36 MB	28 MB	77%



**NOTE:**

Specialized tools are required to change the partition size if the operating system is already installed.

### C.1.2 Supported Operating System

The recovery CD is compatible with both Microsoft Windows and Linux operating system (OS). The supported OS versions are listed below.

- Microsoft Windows
  - Windows XP (Service Pack 2 or 3 required)
  - Windows Vista

- Windows 7
- Windows CE 5.0
- Windows CE 6.0
- Windows XP Embedded
- Linux
  - Fedora Core 12 (Constantine)
  - Fedora Core 11 (Leonidas)
  - Fedora Core 10 (Cambridge)
  - Fedora Core 8 (Werewolf)
  - Fedora Core 7 (Moonshine)
  - RedHat RHEL-5.4
  - RedHat 9 (Ghirke)
  - Ubuntu 8.10 (Intrepid)
  - Ubuntu 7.10 (Gutsy)
  - Ubuntu 6.10 (Edgy)
  - Debian 5.0 (Lenny)
  - Debian 4.0 (Etch)
  - SuSe 11.2
  - SuSe 11.3

**NOTE:**

Installing unsupported OS versions may cause the recovery tool to fail.

---

## NANO-QM57A EPIC SBC



### NOTE:

The recovery CD can only be used with IEI products. The software will fail to run and a warning message will appear when used on non-IEI hardware.

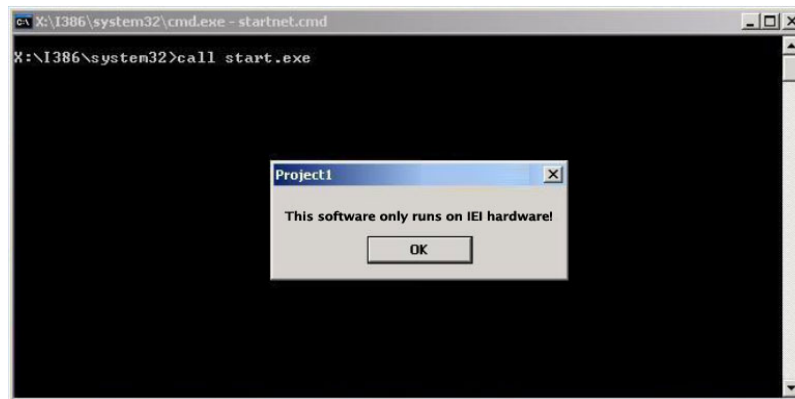

## C.2 Setup Procedure for Windows

Prior to using the recovery tool to backup or restore system, a few setup procedures are required.

- Step 1:** Hardware and BIOS setup
- Step 2:** Create partitions
- Step 3:** Install operating system, drivers and system applications.
- Step 4:** Build-up recovery partition
- Step 5:** Create factory default image

The detailed descriptions are described in the following sections.

**NOTE:**

The setup procedures described below are for Microsoft Windows operating system users. For Linux system, most setup procedures are the same with Microsoft Windows except for several steps which is described in **Section C.3**.

### C.2.1 Hardware and BIOS Setup

- Step 1:** Make sure the system is powered off and unplugged.
- Step 2:** Install a hard driver or SSD in the NANO-QM57A. An unformatted and unpartitioned disk is recommended.
- Step 3:** Connect an optical disk drive to the NANO-QM57A and insert the recovery CD.
- Step 4:** Turn on the system.
- Step 5:** Press the <DELETE> key as soon as the system is turned on to enter the BIOS.
- Step 6:** Select the connected optical disk drive as the 1<sup>st</sup> boot device. (**Boot** → **Boot Device Priority** → **1<sup>st</sup> Boot Device**).
- Step 7:** Save changes and restart the computer. Continue to the next section for instructions on partitioning the internal storage.

### C.2.2 Create Partitions

- Step 1:** Put the recovery CD in the optical drive.
- Step 2:** Turn on the system.
- Step 3:** When prompted, press any key to boot from the recovery CD. It will take a while to launch the recovery tool. Please be patient.
- Step 4:** The recovery tool setup menu is shown as below.

## NANO-QM57A EPIC SBC

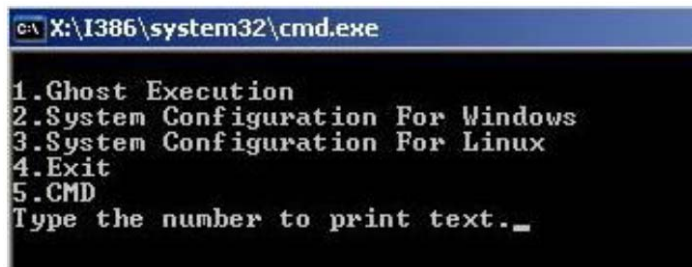

```
C:\X:\I386\system32\cmd.exe
1.Ghost Execution
2.System Configuration For Windows
3.System Configuration For Linux
4.Exit
5.CMD
Type the number to print text._
```

Figure C-1: Recovery Tool Setup Menu

**Step 5:** Press <5> then <Enter>.

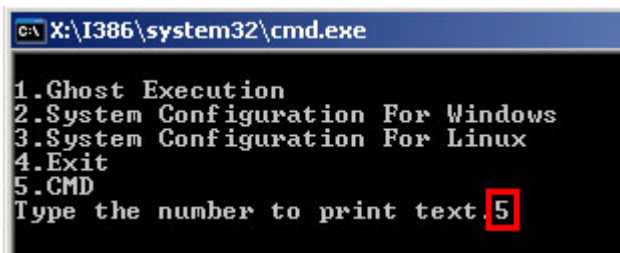

```
C:\X:\I386\system32\cmd.exe
1.Ghost Execution
2.System Configuration For Windows
3.System Configuration For Linux
4.Exit
5.CMD
Type the number to print text. 5
```

Figure C-2: Command Mode

**Step 6:** The command prompt window appears. Type the following commands (marked in red) to create two partitions. One is for the OS installation; the other is for saving recovery files and images which will be an invisible partition.

(Press <Enter> after entering each line below)

```
system32>diskpart
DISKPART>list vol
DISKPART>sel disk 0
DISKPART>create part pri size= ____
DISKPART>assign letter=N
DISKPART>create part pri size= ____
DISKPART>assign letter=F
DISKPART>exit
system32>format N: /fs:ntfs /q /y
```



system32>format F: /fs:ntfs /q /v:Recovery /y

system32>exit

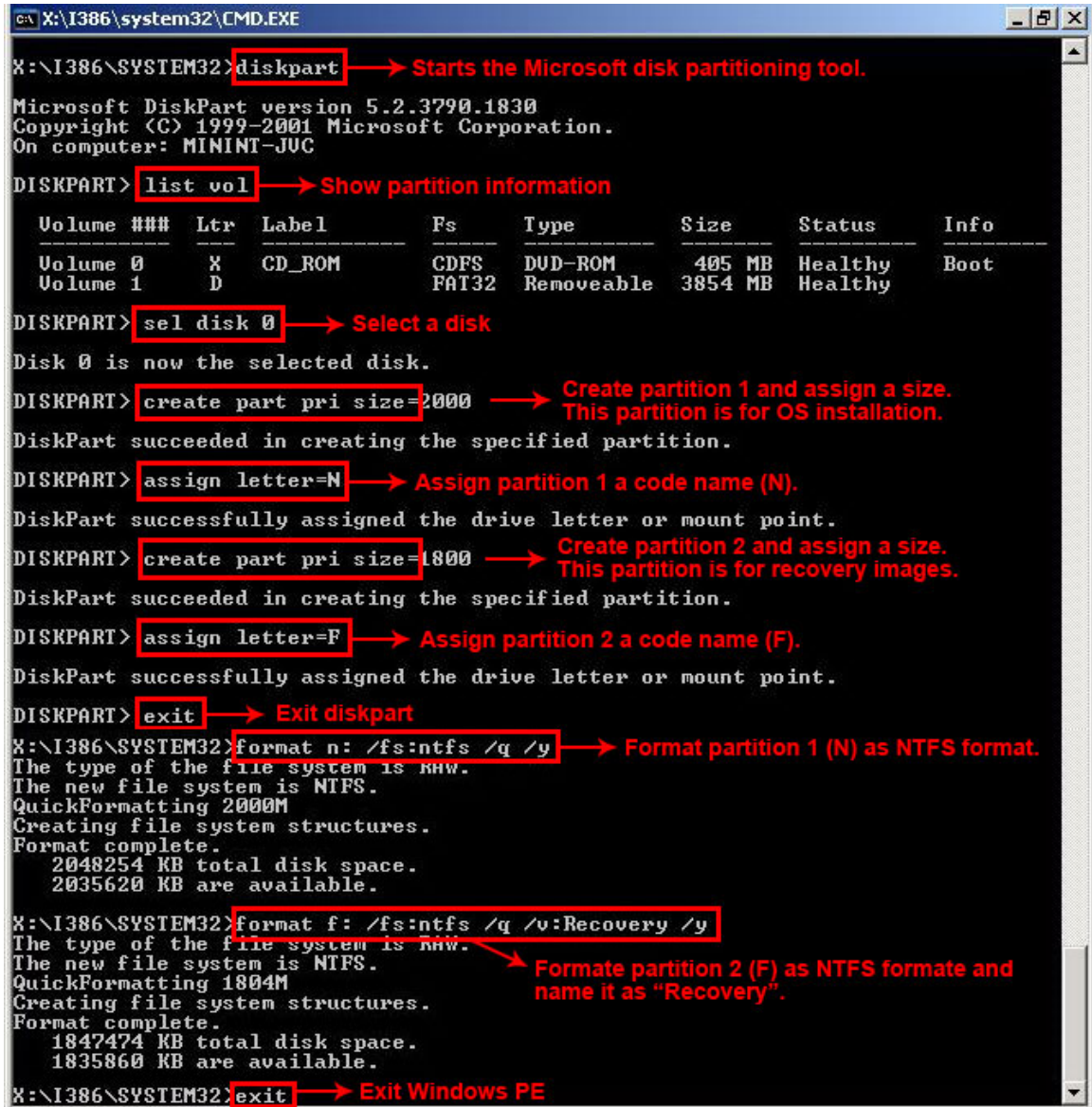

```

X:\I386\SYSTEM32\CMD.EXE
X:\I386\SYSTEM32>diskpart → Starts the Microsoft disk partitioning tool.
Microsoft DiskPart version 5.2.3790.1830
Copyright (C) 1999-2001 Microsoft Corporation.
On computer: MININT-JUC
DISKPART> list vol → Show partition information
Volume ### Ltr Label Fs Type Size Status Info
-----
Volume 0 X CD_ROM GDFS DUD-ROM 405 MB Healthy Boot
Volume 1 D FAT32 Removeable 3854 MB Healthy
DISKPART> sel disk 0 → Select a disk
Disk 0 is now the selected disk.
DISKPART> create part pri size=2000 → Create partition 1 and assign a size.
This partition is for OS installation.
DiskPart succeeded in creating the specified partition.
DISKPART> assign letter=N → Assign partition 1 a code name (N).
DiskPart successfully assigned the drive letter or mount point.
DISKPART> create part pri size=1800 → Create partition 2 and assign a size.
This partition is for recovery images.
DiskPart succeeded in creating the specified partition.
DISKPART> assign letter=F → Assign partition 2 a code name (F).
DiskPart successfully assigned the drive letter or mount point.
DISKPART> exit → Exit diskpart
X:\I386\SYSTEM32>format n: /fs:ntfs /q /y → Format partition 1 (N) as NTFS format.
The type of the file system is ntw.
The new file system is NTFS.
QuickFormatting 2000M
Creating file system structures.
Format complete.
2048254 KB total disk space.
2035620 KB are available.
X:\I386\SYSTEM32>format f: /fs:ntfs /q /v:Recovery /y → Formate partition 2 (F) as NTFS formate and
name it as "Recovery".
The type of the file system is ntw.
The new file system is NTFS.
QuickFormatting 1804M
Creating file system structures.
Format complete.
1847474 KB total disk space.
1835860 KB are available.
X:\I386\SYSTEM32>exit → Exit Windows PE
  
```

Figure C-3: Partition Creation Commands



## NOTE:

Use the following commands to check if the partitions were created successfully.

```
X:\I386\SYSTEM32>diskpart
Microsoft DiskPart version 5.2.3790.1830
Copyright (C) 1999-2001 Microsoft Corporation.
On computer: MININT-JUC

DISKPART> sel disk 0
Disk 0 is now the selected disk.

DISKPART> list part

   Partition ###   Type              Size              Offset
-----
   Partition 1     Primary            2000 MB            32 KB
   Partition 2     Primary            1804 MB           2000 MB

DISKPART> exit
```

**Step 7:** Press any key to exit the recovery tool and automatically reboot the system.

Please continue to the following procedure: Build-up Recovery Partition.

### C.2.3 Install Operating System, Drivers and Applications

Install the operating system onto the unlabelled partition. The partition labeled as "Recovery" is for use by the system recovery tool and should not be used for installing the operating system or any applications.



## NOTE:

The operating system installation program may offer to reformat the chosen partition. DO NOT format the partition again. The partition has already been formatted and is ready for installing the new operating system.

To install the operating system, insert the operating system installation CD into the optical drive. Restart the computer and follow the installation instructions.

### C.2.4 Build-up Recovery Partition

**Step 1:** Put the recover CD in the optical drive.

**Step 2:** Start the system.

**Step 3:** Press any key to boot from the recovery CD. It will take a while to launch the recovery tool. Please be patient.

**Step 4:** When the recovery tool setup menu appears, press <2> then <Enter>.

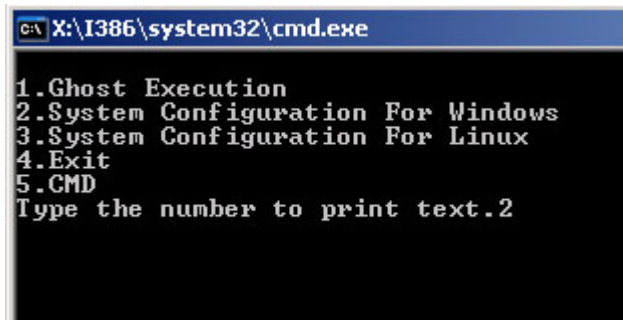

```
C:\X:\I386\system32\cmd.exe
1.Ghost Execution
2.System Configuration For Windows
3.System Configuration For Linux
4.Exit
5.CMD
Type the number to print text.2
```

**Figure C-4: System Configuration for Windows**

**Step 5:** The Symantec Ghost window appears and starts configuring the system to build-up a recovery partition. In this process, the partition which is created for recovery files in **Section C.2.2** is hidden and the recovery tool is saved in this partition.



## NANO-QM57A EPIC SBC

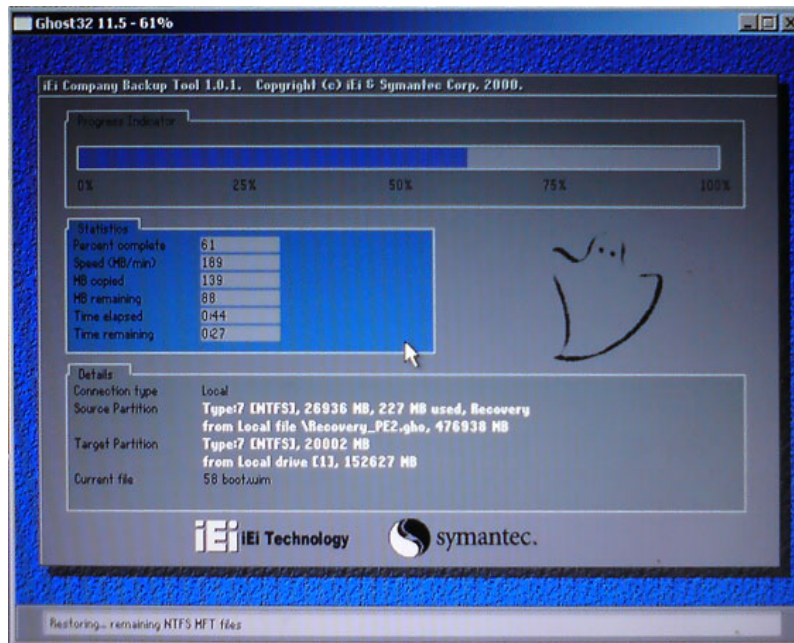

**Figure C-5: Build-up Recovery Partition**

**Step 6:** After completing the system configuration, press any key in the following window to reboot the system.

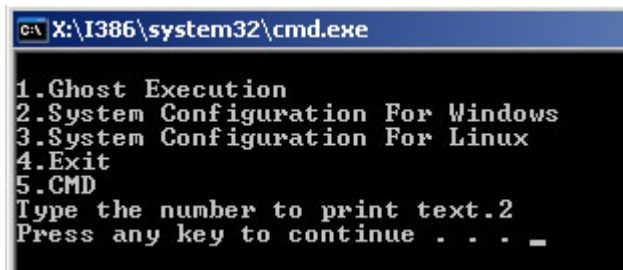

**Figure C-6: Press any key to continue**

**Step 7:** Eject the recovery CD.

## C.2.5 Create Factory Default Image



### NOTE:

Before creating the factory default image, please configure the system to a factory default environment, including driver and application installations.

To create a factory default image, please follow the steps below.

**Step 1:** Turn on the system. When the following screen displays (**Figure A-2**), press the <F3> key to access the recovery tool. The message will display for 10 seconds, please press F3 before the system boots into the operating system.

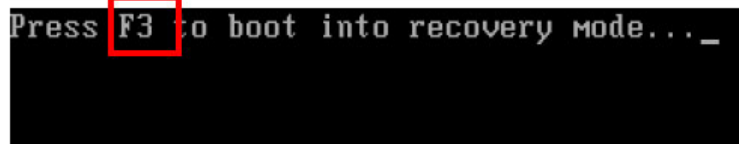

```
Press F3 to boot into recovery mode... _
```

Figure C-7: Press F3 to Boot into Recovery Mode

**Step 2:** The recovery tool menu appears. Type <4> and press <Enter>. (**Figure A-3**)

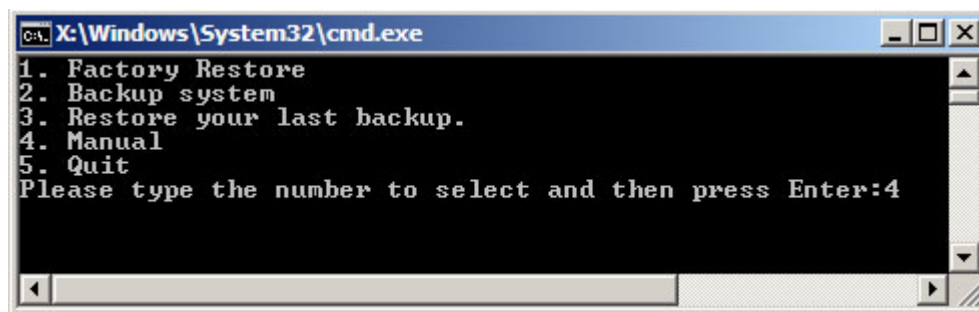

Figure C-8: Recovery Tool Menu

**Step 3:** The About Symantec Ghost window appears. Click **OK** button to continue.



NANO-QM57A EPIC SBC

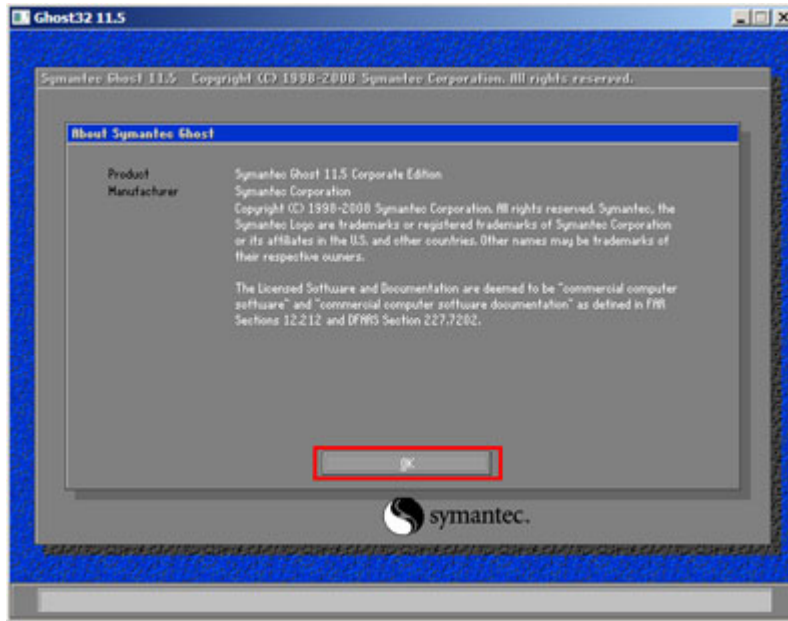

Figure C-9: About Symantec Ghost Window

**Step 4:** Use mouse to navigate to the option shown below (Figure C-10).

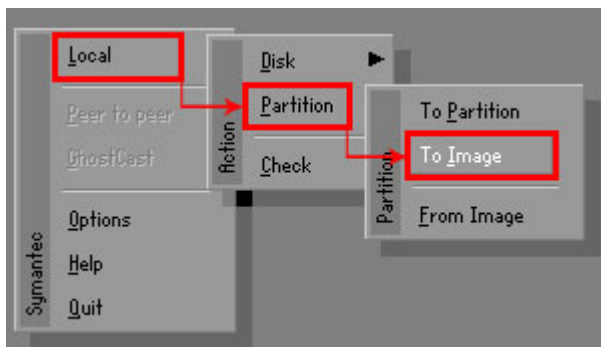
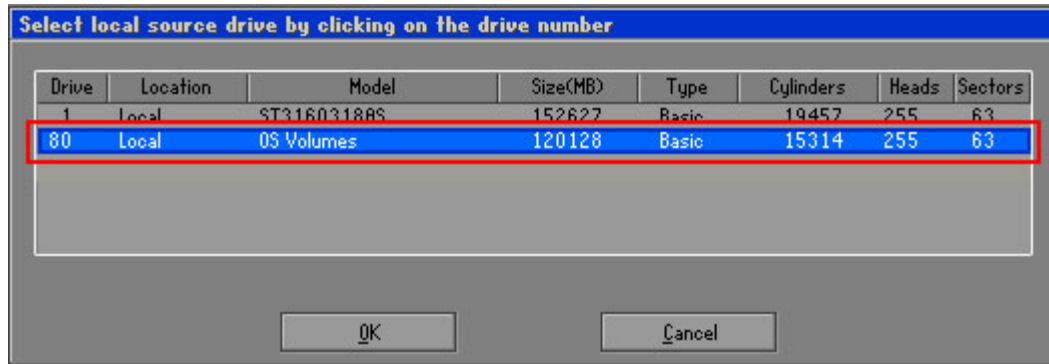

Figure C-10: Symantec Ghost Path

**Step 5:** Select the local source drive as shown in Figure C-11. Then click OK.



**Figure C-11: Select a Local Source Drive**

**Step 6:** Select a source partition from basic drive as shown in **Figure A-4**. Then click OK.

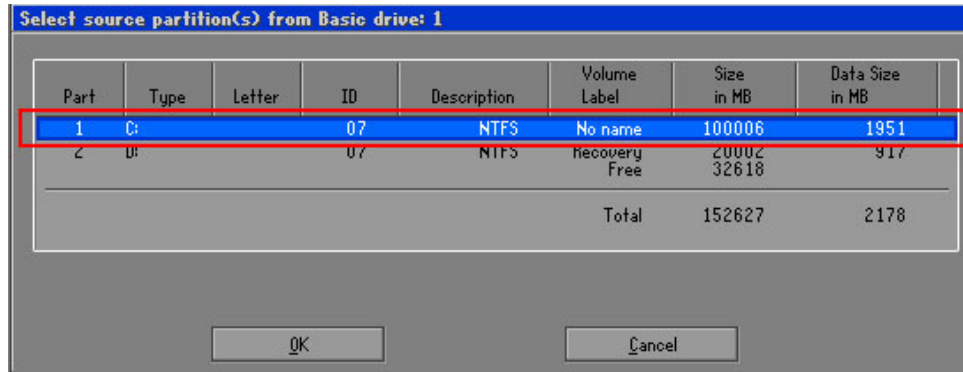

**Figure C-12: Select a Source Partition from Basic Drive**

**Step 7:** Select 1.2: [Recovery] NTFS drive and enter a file name called **iei** (Figure A-5). Click **Save**. The factory default image will then be saved in the selected recovery drive and named IEI.GHO.



**WARNING:**

The file name of the factory default image must be **iei.GHO**.

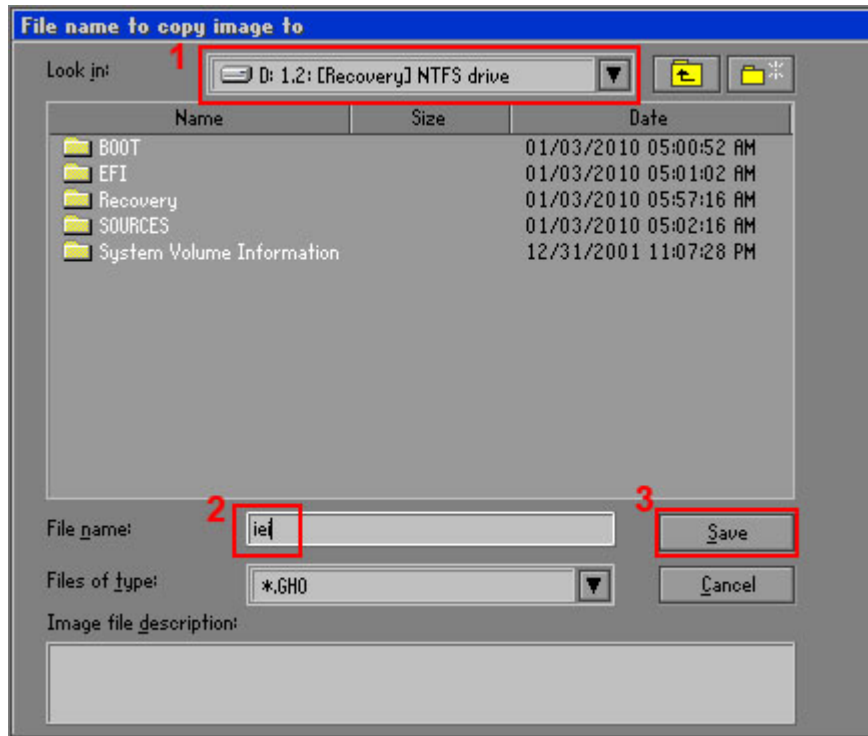

Figure C-13: File Name to Copy Image to

**Step 8:** When the Compress Image screen in **Figure A-6** prompts, click **High** to make the image file smaller.

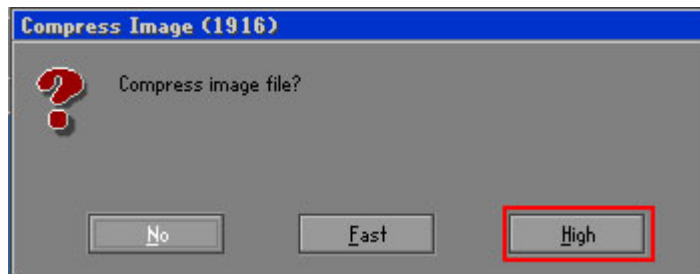
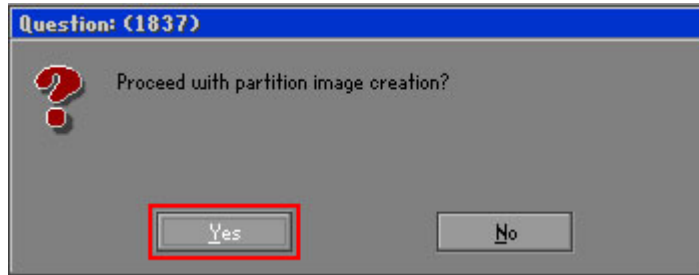

Figure C-14: Compress Image

**Step 9:** The Proceed with partition image creation window appears, click **Yes** to continue.



**Figure C-15: Image Creation Confirmation**

**Step 10:** The Symantec Ghost starts to create the factory default image (**Figure C-16**).

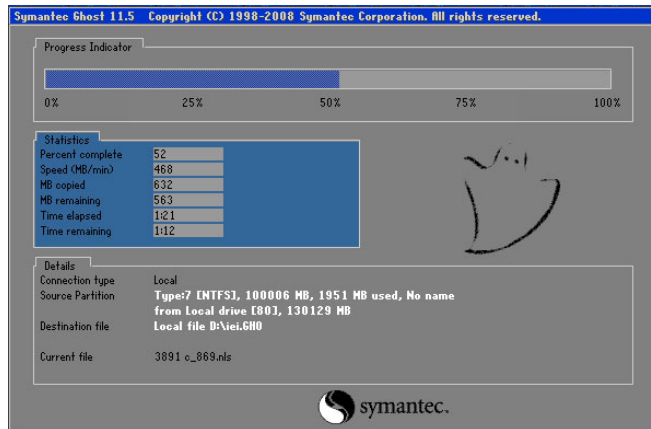

**Figure C-16: Image Creation Complete**

**Step 11:** When the image creation completes, a screen prompts as shown in **Figure A-7**.

Click **Continue** and close the Ghost window to exit the program.

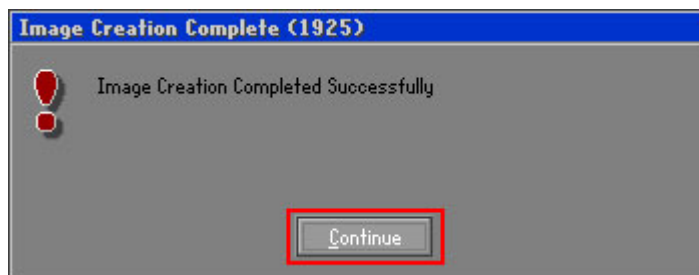
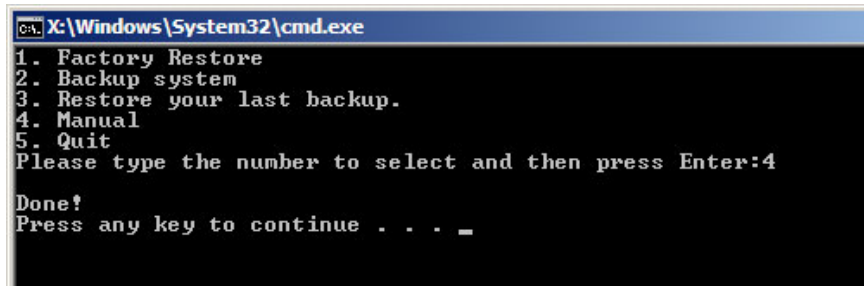

**Figure C-17: Image Creation Complete**



## NANO-QM57A EPIC SBC

**Step 12:** The recovery tool main menu window is shown as below. Press any key to reboot the system.



```
C:\Windows\System32\cmd.exe
1. Factory Restore
2. Backup system
3. Restore your last backup.
4. Manual
5. Quit
Please type the number to select and then press Enter:4
Done!
Press any key to continue . . . _
```

Figure C-18: Press Any Key to Continue

### C.3 Setup Procedure for Linux

The initial setup procedures for Linux system are mostly the same with the procedure for Microsoft Windows. Please follow the steps below to setup recovery tool for Linux OS.

**Step 1:** **Hardware and BIOS setup.** Refer to **Section C.2.1.**

**Step 2:** **Install Linux operating system.** Make sure to install GRUB (v0.97 or earlier) MBR type and Ext3 partition type. Leave enough space on the hard drive to create the recover partition later.



#### NOTE:

If the Linux OS is not installed with GRUB (v0.97 or earlier) and Ext3, the Symantec Ghost may not function properly.

---

While installing Linux OS, please create two partitions:

- Partition 1: /
- Partition 2: **SWAP**





**NOTE:**

Please reserve enough space for partition 3 for saving recovery images.

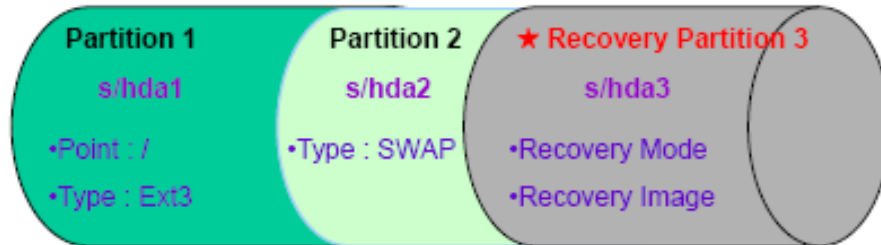

Figure C-19: Partitions for Linux

**Step 3:** Create a recovery partition. Insert the recovery CD into the optical disk drive.

Follow **Step 1 ~ Step 3** described in **Section C.2.2**. Then type the following commands (marked in red) to create a partition for recovery images.

```
system32>diskpart
DISKPART>list vol
DISKPART>sel disk 0
DISKPART>create part pri size= ____
DISKPART>assign letter=N
DISKPART>exit
system32>format N: /fs:ntfs /q /v:Recovery /y
system32>exit
```

**Step 4:** Build-up recovery partition. Press any key to boot from the recovery CD. It will take a while to launch the recovery tool. Please be patient. When the recovery tool setup menu appears, type <3> and press <Enter> (**Figure C-20**). The Symantec Ghost window appears and starts configuring the system to build-up a

## NANO-QM57A EPIC SBC

recovery partition. After completing the system configuration, press any key to reboot the system. Eject the recovery CD.

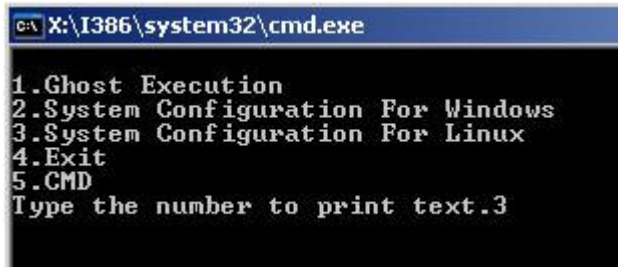

```
C:\X:\I386\system32\cmd.exe
1.Ghost Execution
2.System Configuration For Windows
3.System Configuration For Linux
4.Exit
5.CMD
Type the number to print text.3
```

Figure C-20: System Configuration for Linux

**Step 5:** Access the recovery tool main menu by modifying the “menu.lst”. To first access the recovery tool main menu, the menu.lst must be modified. In Linux system, enter Administrator (root). When prompt appears, type:

```
cd /boot/grub
```

```
vi menu.lst
```

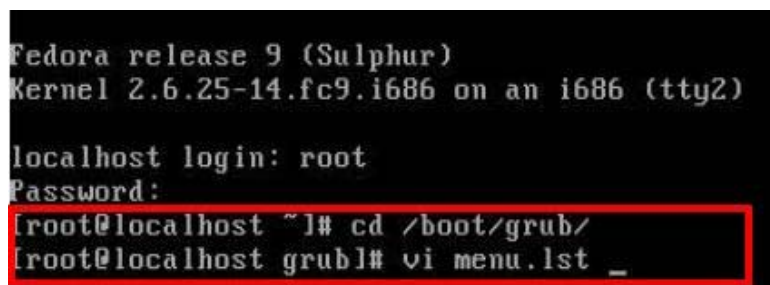

```
Fedora release 9 (Sulphur)
Kernel 2.6.25-14.fc9.i686 on an i686 (tty2)

localhost login: root
Password:
[root@localhost ~]# cd /boot/grub/
[root@localhost grub]# vi menu.lst _
```

Figure C-21: Access menu.lst in Linux (Text Mode)

**Step 6:** Modify the menu.lst as shown below.

```
#boot=/dev/sda
default=0
timeout=10
splashimage=(hd0,0)/grub/splash.xpm.gz
hiddenmenu
title Fedora (2.6.25-14.fc9.i686)
    root (hd0,0)
    kernel /vmlinuz-2.6.25-14.fc9.i686 ro root=UUID=10f1acd
ac38b5c78910 rhgb quiet
    initrd /initrd-2.6.25-14.fc9.i686.img

title Recovery Partition
    root (hd0,2)
    makeactive
    chainloader +1
```

- **Type command:**  
**title Recovery Partition**  
**root (hd0,2)**  
**makeactive**  
**chainloader +1**

**Step 7:** The recovery tool menu appears. (Figure C-22)

```
1. Factory Restore
2. Backup system
3. Restore your last backup.
4. Manual
5. Quit
Please type the number to select and then press Enter:
```

**Figure C-22: Recovery Tool Menu**

**Step 8:** Create a factory default image. Follow **Step 2 ~ Step 12** described in **Section C.2.5** to create a factory default image.

## C.4 Recovery Tool Functions

After completing the initial setup procedures as described above, users can access the recovery tool by pressing **<F3>** while booting up the system. The main menu of the recovery tool is shown below.

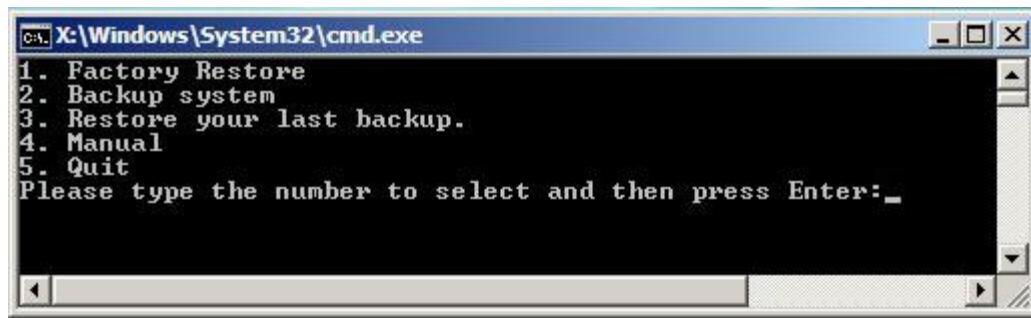

**Figure C-23: Recovery Tool Main Menu**

The recovery tool has several functions including:

1. **Factory Restore:** Restore the factory default image (iei.GHO) created in **Section C.2.5.**
2. **Backup system:** Create a system backup image (iei\_user.GHO) which will be saved in the hidden partition.
3. **Restore your last backup:** Restore the last system backup image
4. **Manual:** Enter the Symantec Ghost window to configure manually.
5. **Quit:** Exit the recovery tool and restart the system.



**WARNING:**

Please do not turn off the system power during the process of system recovery or backup.



**WARNING:**

All data in the system will be deleted during the system recovery. Please backup the system files before restoring the system (either Factory Restore or Restore Backup).



### C.4.1 Factory Restore

To restore the factory default image, please follow the steps below.

**Step 1:** Type <1> and press <Enter> in the main menu.

**Step 2:** The Symantec Ghost window appears and starts to restore the factory default. A factory default image called **iei.GHO** is created in the hidden Recovery partition.

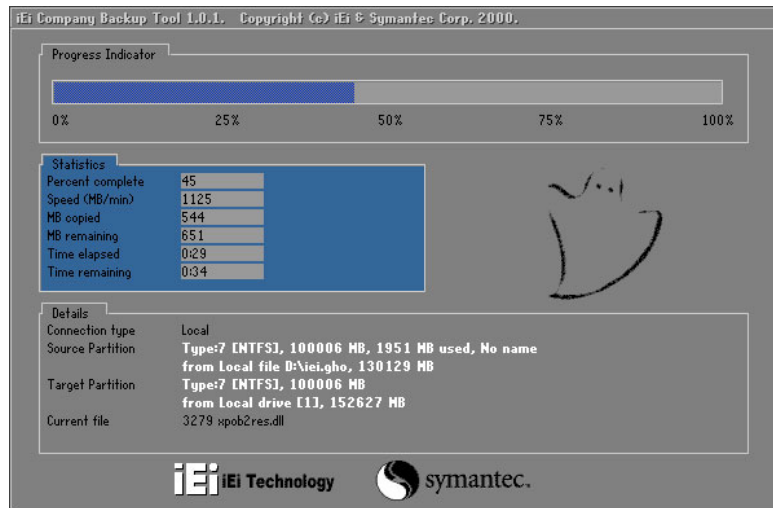

**Figure C-24: Restore Factory Default**

**Step 3:** The screen is shown as in **Figure A-8** when completed. Press any key to reboot the system.

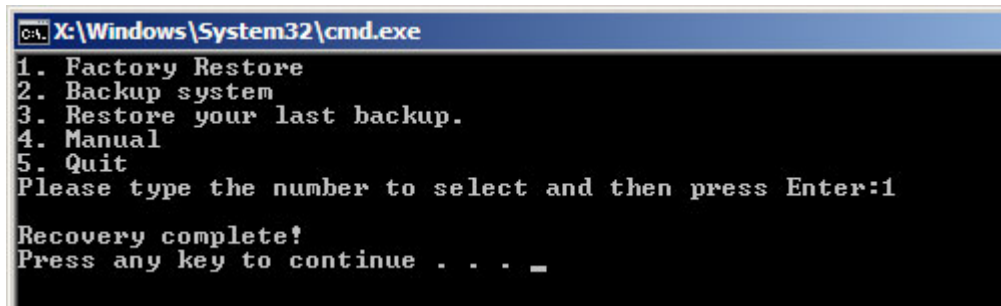

**Figure C-25: Recovery Complete Window**



## NANO-QM57A EPIC SBC

### C.4.2 Backup System

To backup the system, please follow the steps below.

**Step 1:** Type <2> and press <Enter> in the main menu.

**Step 2:** The Symantec Ghost window appears and starts to backup the system. A backup image called `iei_user.GHO` is created in the hidden Recovery partition.

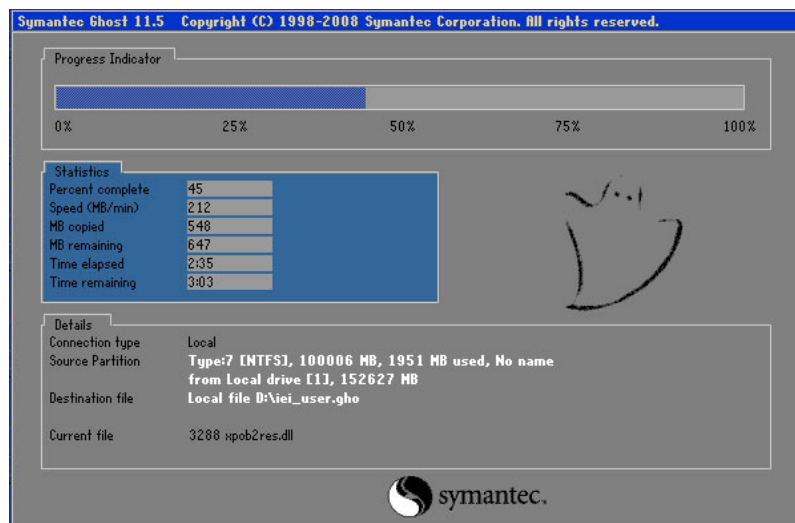

Figure C-26: Backup System

**Step 3:** The screen is shown as in **Figure A-8** when system backup is completed. Press any key to reboot the system.

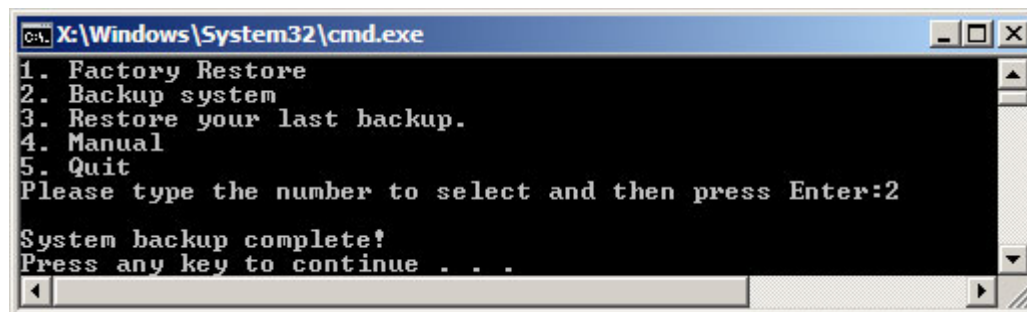

Figure C-27: System Backup Complete Window

### C.4.3 Restore Your Last Backup

To restore the last system backup, please follow the steps below.

**Step 1:** Type <3> and press <Enter> in the main menu.

**Step 2:** The Symantec Ghost window appears and starts to restore the last backup image (iei\_user.GHO).

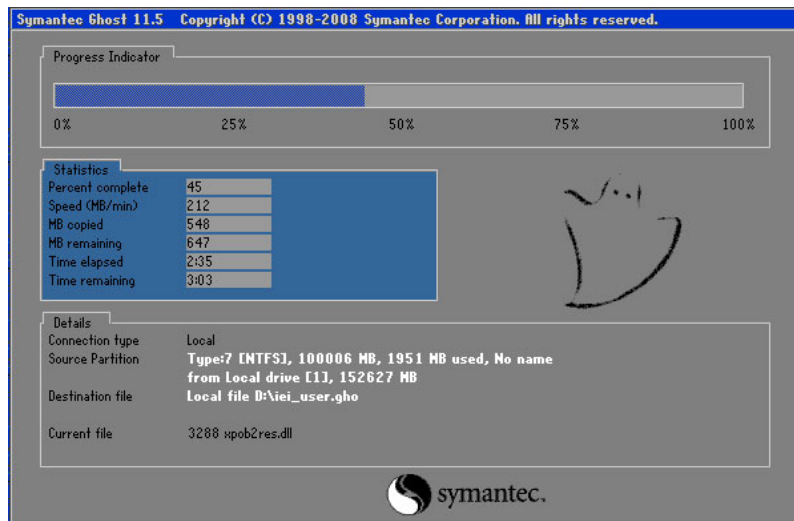

**Figure C-28: Restore Backup**

**Step 3:** The screen is shown as in **Figure A-8** when backup recovery is completed.

Press any key to reboot the system.

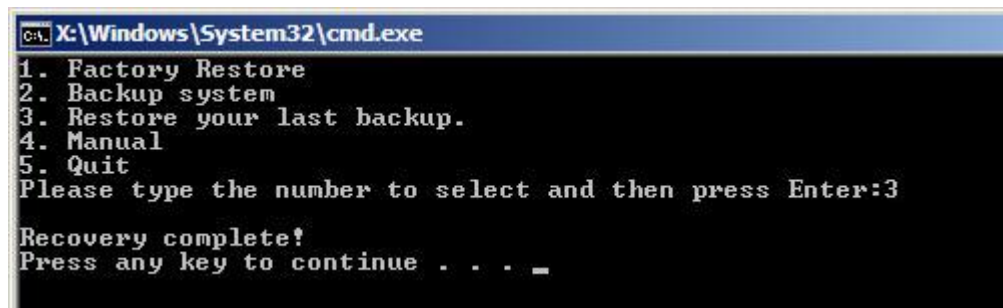

**Figure C-29: Restore System Backup Complete Window**

## NANO-QM57A EPIC SBC

### C.4.4 Manual

To restore the last system backup, please follow the steps below.

**Step 1:** Type <4> and press <Enter> in the main menu.

**Step 2:** The Symantec Ghost window appears. Use the Ghost program to backup or recover the system manually.

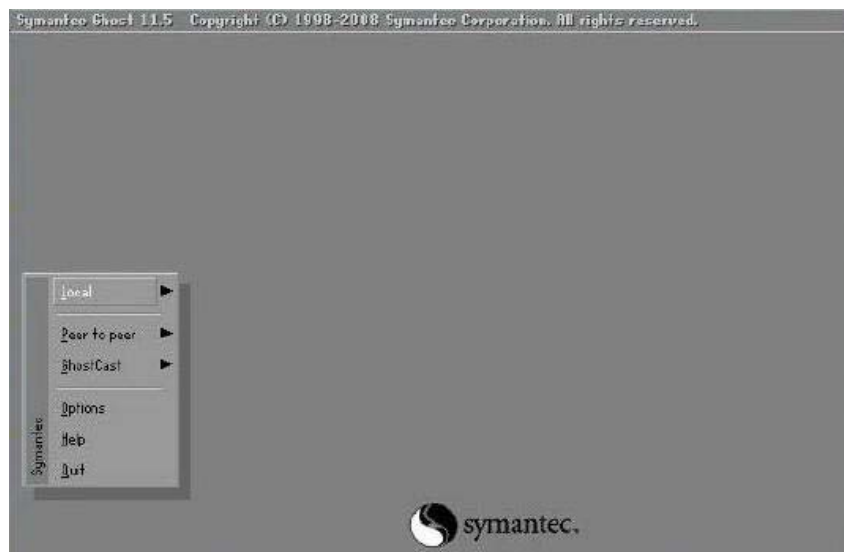

**Figure C-30: Symantec Ghost Window**

**Step 3:** When backup or recovery is completed, press any key to reboot the system.

Appendix

D

# Terminology

---

## NANO-QM57A EPIC SBC

AC '97	Audio Codec 97 (AC'97) refers to a codec standard developed by Intel® in 1997.
ACPI	Advanced Configuration and Power Interface (ACPI) is an OS-directed configuration, power management, and thermal management interface.
AHCI	Advanced Host Controller Interface (AHCI) is a SATA Host controller register-level interface.
ATA	The Advanced Technology Attachment (ATA) interface connects storage devices including hard disks and CD-ROM drives to a computer.
APM	The Advanced Power Management (APM) application program interface (API) enables the inclusion of power management in the BIOS.
ARMD	An ATAPI Removable Media Device (ARMD) is any ATAPI device that supports removable media, besides CD and DVD drives.
ASKIR	Amplitude Shift Keyed Infrared (ASKIR) is a form of modulation that represents a digital signal by varying the amplitude (“volume”) of the signal. A low amplitude signal represents a binary 0, while a high amplitude signal represents a binary 1.
BIOS	The Basic Input/Output System (BIOS) is firmware that is first run when the computer is turned on and can be configured by the end user
CODEC	The Compressor-Decompressor (CODEC) encodes and decodes digital audio data on the system.
CMOS	Complimentary metal-oxide-conductor is a type of integrated circuit used in chips like static RAM and microprocessors.
COM	COM is used to refer to serial ports. Serial ports offer serial communication to expansion devices. The serial port on a personal



	computer is usually a male DE-9 connector.
DAC	The Digital-to-Analog Converter (DAC) converts digital signals to analog signals.
DDR	Double Data Rate refers to a data bus transferring data on both the rising and falling edges of the clock signal.
DMA	Direct Memory Access (DMA) enables some peripheral devices to bypass the system processor and communicate directly with the system memory.
DIMM	Dual Inline Memory Modules are a type of RAM that offer a 64-bit data bus and have separate electrical contacts on each side of the module.
EHCI	The Enhanced Host Controller Interface (EHCI) specification is a register-level interface description for USB 2.0 Host Controllers.
GbE	Gigabit Ethernet (GbE) is an Ethernet version that transfers data at 1.0 Gbps and complies with the IEEE 802.3-2005 standard.
GPIO	General purpose input
IrDA	Infrared Data Association (IrDA) specify infrared data transmission protocols used to enable electronic devices to wirelessly communicate with each other.
L1 Cache	The Level 1 Cache (L1 Cache) is a small memory cache built into the system processor.
L2 Cache	The Level 2 Cache (L2 Cache) is an external processor memory cache.
LVDS	Low-voltage differential signaling (LVDS) is a dual-wire, high-speed differential electrical signaling system commonly used to connect LCD displays to a computer.
MAC	The Media Access Control (MAC) protocol enables several terminals or network nodes to communicate in a LAN, or other multipoint networks.

## NANO-QM57A EPIC SBC

PCIe	PCI Express (PCIe) is a communications bus that uses dual data lines for full-duplex (two-way) serial (point-to-point) communications between the SBC components and/or expansion cards and the SBC chipsets. Each line has a 2.5 Gbps data transmission rate and a 250 MBps sustained data transfer rate.
POST	The Power-on Self Test (POST) is the pre-boot actions the system performs when the system is turned-on.
QVGA	Quarter Video Graphics Array (QVGA) refers to a display with a resolution of 320 x 240 pixels.
RAM	Random Access Memory (RAM) is a form of storage used in computer. RAM is volatile memory, so it loses its data when power is lost. RAM has very fast data transfer rates compared to other storage like hard drives.
SATA	Serial ATA (SATA) is a serial communications bus designed for data transfers between storage devices and the computer chipsets. The SATA bus has transfer speeds up to 1.5 Gbps and the SATA 3Gb/s bus has data transfer speeds of up to 3.0 Gbps.
S.M.A.R.T	Self Monitoring Analysis and Reporting Technology (S.M.A.R.T) refers to automatic status checking technology implemented on hard disk drives.
UART	Universal Asynchronous Receiver-transmitter (UART) is responsible for asynchronous communications on the system and manages the system's serial communication (COM) ports.
UHCI	The Universal Host Controller Interface (UHCI) specification is a register-level interface description for USB 1.1 Host Controllers.
USB	The Universal Serial Bus (USB) is an external bus standard for interfacing devices. USB 1.1 supports 12Mbps data transfer rates, while

USB 2.0 supports 480Mbps data transfer rates.

VGA

The Video Graphics Array (VGA) is a graphics display system developed by IBM.

Appendix

E

# Watchdog Timer

---

**NOTE:**

The following discussion applies to DOS environment. IEI support is contacted or the IEI website visited for specific drivers for more sophisticated operating systems, e.g., Windows and Linux.

The Watchdog Timer is provided to ensure that standalone systems can always recover from catastrophic conditions that cause the CPU to crash. This condition may have occurred by external EMI or a software bug. When the CPU stops working correctly, Watchdog Timer either performs a hardware reset (cold boot) or a Non-Maskable Interrupt (NMI) to bring the system back to a known state.

A BIOS function call (INT 15H) is used to control the Watchdog Timer:

**INT 15H:**

<b>AH – 6FH Sub-function:</b>	
AL – 2:	Sets the Watchdog Timer's period.
BL:	Time-out value (Its unit-second is dependent on the item "Watchdog Timer unit select" in CMOS setup).

**Table E-1: AH-6FH Sub-function**

Call sub-function 2 to set the time-out period of Watchdog Timer first. If the time-out value is not zero, the Watchdog Timer starts counting down. While the timer value reaches zero, the system resets. To ensure that this reset condition does not occur, calling sub-function 2 must periodically refresh the Watchdog Timer. However, the Watchdog timer is disabled if the time-out value is set to zero.

A tolerance of at least 10% must be maintained to avoid unknown routines within the operating system (DOS), such as disk I/O that can be very time-consuming.





## NOTE:

When exiting a program it is necessary to disable the Watchdog Timer, otherwise the system resets.

### Example program:

**; INITIAL TIMER PERIOD COUNTER**

;

W\_LOOP:

```

MOV    AX, 6F02H    ;setting the time-out value
MOV    BL, 30H      ;time-out value is 48 seconds
INT    15H

```

;

**; ADD THE APPLICATION PROGRAM HERE**

;

```

CMP    EXIT_AP, 1    ;is the application over?
JNE    W_LOOP       ;No, restart the application

```

```

MOV    AX, 6F02H    ;disable Watchdog Timer
MOV    BL, 0        ;
INT    15H

```

;

**; EXIT ;**

Appendix

F

# Hazardous Materials Disclosure

---

## **F.1 Hazardous Material Disclosure Table for IPB Products Certified as RoHS Compliant Under 2002/95/EC Without Mercury**

The details provided in this appendix are to ensure that the product is compliant with the Peoples Republic of China (China) RoHS standards. The table below acknowledges the presences of small quantities of certain materials in the product, and is applicable to China RoHS only.

A label will be placed on each product to indicate the estimated “Environmentally Friendly Use Period” (EFUP). This is an estimate of the number of years that these substances would “not leak out or undergo abrupt change.” This product may contain replaceable sub-assemblies/components which have a shorter EFUP such as batteries and lamps. These components will be separately marked.

Please refer to the table on the next page.

Part Name	Toxic or Hazardous Substances and Elements					
	Lead (Pb)	Mercury (Hg)	Cadmium (Cd)	Hexavalent Chromium (CR(VI))	Polybrominated Biphenyls (PBB)	Polybrominated Diphenyl Ethers (PBDE)
Housing	X	O	O	O	O	X
Display	X	O	O	O	O	X
Printed Circuit Board	X	O	O	O	O	X
Metal Fasteners	X	O	O	O	O	O
Cable Assembly	X	O	O	O	O	X
Fan Assembly	X	O	O	O	O	X
Power Supply Assemblies	X	O	O	O	O	X
Battery	O	O	O	O	O	O

O: This toxic or hazardous substance is contained in all of the homogeneous materials for the part is below the limit requirement in SJ/T11363-2006

X: This toxic or hazardous substance is contained in at least one of the homogeneous materials for this part is above the limit requirement in SJ/T11363-2006

## NANO-QM57A EPIC SBC

此附件旨在确保本产品符合中国 RoHS 标准。以下表格标示此产品中某有毒物质的含量符合中国 RoHS 标准规定的限量要求。

本产品上会附有“环境友好使用期限”的标签，此期限是估算这些物质“不会有泄漏或突变”的年限。本产品可能包含有较短的环境友好使用期限的可替换元件，像是电池或灯管，这些元件将会单独标示出来。

部件名称	有毒有害物质或元素					
	铅 (Pb)	汞 (Hg)	镉 (Cd)	六价铬 (CR(VI))	多溴联苯 (PBB)	多溴二苯醚 (PBDE)
壳体	X	O	O	O	O	X
显示	X	O	O	O	O	X
印刷电路板	X	O	O	O	O	X
金属螺帽	X	O	O	O	O	O
电缆组装	X	O	O	O	O	X
风扇组装	X	O	O	O	O	X
电力供应组装	X	O	O	O	O	X
电池	O	O	O	O	O	O

O: 表示该有毒有害物质在该部件所有物质材料中的含量均在 SJ/T11363-2006 标准规定的限量要求以下。

X: 表示该有毒有害物质至少在该部件的某一均质材料中的含量超出 SJ/T11363-2006 标准规定的限量要求。