



IEI Technology Corp.



MODEL:
PPC-5xxx-9455

**Industrial Panel PC for LGA775 Intel™ Core®2 Duo
TFT LCD, Dual Gigabit Ethernet, Touch Screen
RoHS Compliant, IP 65 Protection**

User Manual

Rev. 1.10 – 28 September, 2012



Revision

Date	Version	Changes
28 September, 2012	1.10	Updated Section 1.1.1: Model Variations Updated Section 2.1.4: Power Supply Changed Ethernet controller from Broadcom BCM5787M to Realtek RTL8111CP
9 March, 2011	1.01	Added Section 4.5.6.5 COM5 RS-422 and RS-485 Pinouts
August, 2008	1.00	Initial release

Copyright

COPYRIGHT NOTICE

The information in this document is subject to change without prior notice in order to improve reliability, design and function and does not represent a commitment on the part of the manufacturer.

In no event will the manufacturer be liable for direct, indirect, special, incidental, or consequential damages arising out of the use or inability to use the product or documentation, even if advised of the possibility of such damages.

This document contains proprietary information protected by copyright. All rights are reserved. No part of this manual may be reproduced by any mechanical, electronic, or other means in any form without prior written permission of the manufacturer.

TRADEMARKS

All registered trademarks and product names mentioned herein are used for identification purposes only and may be trademarks and/or registered trademarks of their respective owners.

Manual Conventions

 **WARNING!**

Warnings appear where overlooked details may cause damage to the equipment or result in personal injury. Warnings should be taken seriously. Warnings are easy to recognize. The word “warning” is written as “**WARNING**,” both capitalized and bold and is followed by text. The text is the warning message. A warning message is shown below:

 **WARNING:**

This is an example of a warning message. Failure to adhere to warning messages may result in permanent damage to the PPC-5xxx-9455 or personal injury to the user. Please take warning messages seriously.

 **CAUTION!**

Cautionary messages should also be heeded to help reduce the chance of losing data or damaging the PPC-5xxx-9455. Cautions are easy to recognize. The word “caution” is written as “**CAUTION**,” both capitalized and bold and is followed. The text is the cautionary message. A caution message is shown below:

 **CAUTION:**

This is an example of a caution message. Failure to adhere to cautions messages may result in permanent damage to the PPC-5xxx-9455. Please take caution messages seriously.

 **NOTE:**

These messages inform the reader of essential but non-critical information. These messages should be read carefully as any directions or instructions contained therein can help avoid making mistakes. Notes are easy to recognize. The word “note” is written as “**NOTE**,” both capitalized and bold and is followed by text. The text is the cautionary message. A note message is shown below:

 **NOTE:**

This is an example of a note message. Notes should always be read. Notes contain critical information about the PPC-5xxx-9455. Please take note messages seriously.

Packing List

**NOTE:**

If any of the components listed in the checklist below are missing, please do not proceed with the installation. Contact the IEI reseller or vendor you purchased the PPC-5xxx-9455 from or contact an IEI sales representative directly. To contact an IEI sales representative, please send an email to sales@iei.com.tw.

The items listed below should all be included in the PPC-5xxx-9455 package.

- 1 x PPC-5xxx-9455
- 1 x Hard drive bracket
- 1 x IDE cable (40-pin to 40-pin)
- 1 x IDE cable (44-pin to 44-pin)
- 1 x Jumper pack
- 1 x Wall mounting kit
- 1 x Power cord
- 1 x Screw set
- 1 x IDE adapter for slim-type optical drive
- 1 x Utility CD
- 1 x QIG (quick installation guide)

Images of the above items are shown in **Chapter 3**.

Table of Contents

1 INTRODUCTION.....	1
1.1 GENERAL OVERVIEW	2
1.1.1 Model Variations.....	3
1.1.2 Applications	3
1.1.3 Features	3
1.2 EXTERNAL OVERVIEW.....	4
1.2.1 Front Panel	4
1.2.2 Rear Panel	5
1.2.3 Top Panel	5
1.2.4 Bottom Panel.....	6
1.2.5 Left Panel.....	7
1.2.6 Right Panel.....	7
1.3 INTERNAL OVERVIEW.....	8
2 SPECIFICATIONS.....	9
2.1 INTRODUCTION.....	10
2.1.1 System Specifications.....	10
2.1.2 Motherboard Specifications.....	12
2.1.3 Flat Panel Screen.....	13
2.1.3.1 PPC-5150A-9455 Screen	13
2.1.3.2 PPC-5170A-9455 Screen	14
2.1.3.3 PPC-5190A-9455 Screen	15
2.1.4 Power Supply	16
2.1.4.1 ACE-A618A Power Supply	17
2.1.4.2 ACE-4520C Power Supply	17
2.1.4.3 ACE-A622A Power Supply	19
2.2 DIMENSIONS.....	19
2.2.1 PPC-5150A-9455 Dimensions.....	20
2.2.2 PPC-5170A-9455 Dimensions.....	21
2.2.3 PPC-5190A-9455 Dimensions.....	22
2.3 MOTHERBOARD.....	23

2.4 CPU SUPPORT	23
2.5 SYSTEM CHIPSETS	23
2.5.1 Intel® 945G Northbridge Chipset	24
2.5.2 ICH7 Southbridge Chipset.....	24
2.6 GRAPHICS SUPPORT.....	25
2.6.1 Analog CRT Support	26
2.6.2 LVDS Support	26
2.7 MEMORY	26
2.8 STORAGE.....	27
2.8.1 CompactFlash®	27
2.8.2 SATA Hard Drive.....	28
2.9 EXPANSION SLOTS.....	29
2.10 EXTERNAL DEVICE CONNECTORS	30
2.10.1 USB 2.0 Ports.....	30
2.10.2 Serial Ports	31
2.10.3 Parallel Port	31
2.11 GIGABIT ETHERNET.....	32
2.12 FRONT PANEL.....	32
2.12.1 Flat Screen	32
2.12.2 Touch Screen	33
2.13 OEM OPTIONS	33
3 UNPACKING	34
3.1 ANTI-STATIC PRECAUTIONS	35
3.2 UNPACKING PRECAUTIONS.....	35
3.3 PACKAGE CONTENTS.....	36
4 INSTALLATION AND CONFIGURATION	38
4.1 INSTALLATION PRECAUTIONS	39
4.2 PREINSTALLED COMPONENTS.....	39
4.3 INSTALLATION AND CONFIGURATION STEPS	40
4.4 REMOVE THE BACK COVER.....	41
4.5 JUMPER SETTINGS	42
4.5.1 AT/ATX Power Selection (AT_PWR_SW1)	43
4.5.2 Clear CMOS Setup (JP2).....	43

PPC-5xxx-9455 Panel PC

4.5.3 Monitor Setup (JP1).....	44
4.5.4 CF Card Setup (JP7).....	45
4.5.5 COM Port RI and Voltage Selection (JP3, JP4, JP5, JP6, JP8)	45
4.5.6 COM5 RS-232/422/485 Settings	46
4.5.6.1 COM5 RS-232/422/485 RX Select (J2)	46
4.5.6.2 COM5 RS-422/485 TX Select (J3).....	46
4.5.6.3 COM5 D-Sub Pinout Selection (J4)	47
4.5.6.4 COM5 Termination Resistors (J5, J6).....	47
4.5.6.5 COM5 RS-422 and RS-485 Pinouts	47
4.5.7 LCD Voltage Settings (JP9)	48
4.5.8 Touch Screen Selection (JP7).....	48
4.6 DRIVE INSTALLATION	48
4.6.1 Hard Drive Installation.....	49
4.6.2 CompactFlash [®] Installation.....	51
4.6.3 CD Drive Installation	52
4.7 MOUNTING THE SYSTEM	57
4.7.1 Wall Mounting.....	57
4.7.2 Panel/ Mounting.....	60
4.7.3 Rack and Cabinet Installation	64
4.7.4 Arm Mounting	66
4.8 EXTERNAL PERIPHERAL INTERFACE CONNECTORS.....	67
4.8.1 LCD Panel Connection	67
4.8.2 Ethernet Connection	67
4.8.3 USB Connection.....	68
4.8.4 Keyboard and Mouse Connection.....	68
4.8.5 Parallel Port Connection.....	68
4.8.6 Serial Port Connection	68
4.8.7 Audio Port Connection.....	68
5 BIOS SETUP	69
5.1 INTRODUCTION.....	70
5.1.1 Starting Setup.....	70
5.1.2 Using Setup	70
5.1.3 Getting Help.....	71
5.1.4 Unable to Reboot After Configuration Changes.....	71

5.1.5 BIOS Menu Bar.....	71
5.2 MAIN.....	72
5.3 ADVANCED.....	73
5.3.1 CPU Configuration.....	75
5.3.2 IDE Configuration.....	77
5.3.2.1 IDE Master, IDE Slave.....	79
5.3.3 Floppy Configuration.....	84
5.3.4 Super IO Configuration.....	85
5.3.5 Hardware Health Configuration.....	90
5.3.6 Power Configuration.....	95
5.3.6.1 ACPI Configuration.....	96
5.3.6.2 APM Configuration.....	97
5.3.7 Remote Access Configuration.....	100
5.3.8 USB Configuration.....	103
5.3.8.1 USB Mass Storage Device Configuration.....	105
5.4 PCI/PNP.....	107
5.5 BOOT.....	109
5.5.1 Boot Settings Configuration.....	110
5.5.2 Boot Device Priority.....	112
5.5.3 Hard Disk Drives.....	112
5.5.4 CD/DVD Drives.....	114
5.6 SECURITY.....	116
5.7 CHIPSET.....	117
5.7.1 Northbridge Configuration.....	118
5.7.2 Southbridge Configuration.....	120
5.8 EXIT.....	121
6 SOFTWARE INSTALLATION.....	123
6.1 AVAILABLE SOFTWARE DRIVERS.....	124
6.2 CHIPSET DRIVER.....	124
6.3 GRAPHICS DRIVER.....	128
6.4 GIGABIT ETHERNET DRIVER INSTALLATION.....	133
6.5 AUDIO DRIVER.....	137
6.5.1 BIOS Setup.....	137
6.5.2 Driver Installation.....	138

PPC-5xxx-9455 Panel PC

6.6 TOUCH PANEL DRIVER	139
7 SYSTEM MAINTENANCE	144
7.1 SYSTEM MAINTENANCE INTRODUCTION	145
7.2 MOTHERBOARD REPLACEMENT	145
7.3 BACK COVER REMOVAL.....	145
7.4 DIMM REPLACEMENT	146
7.5 ELEVATED PLATFORM REMOVAL	147
7.6 PSU MODULE REPLACEMENT	149
7.6.1 Remove the Old PSU.....	149
7.6.2 Install the New PSU.....	151
7.7 SYSTEM COOLING FAN REPLACEMENT.....	152
7.7.1 Remove the Old System Cooling Fans.....	152
7.7.2 Install the New System Cooling Fans	153
A BIOS OPTIONS	154
B TERMINOLOGY.....	158
C DIGITAL I/O INTERFACE.....	162
C.1 INTRODUCTION	163
C.2 DIO CONNECTOR PINOUTS.....	163
C.3 ASSEMBLY LANGUAGE SAMPLES.....	164
C.3.1 Enable the DIO Input Function.....	164
C.3.2 Enable the DIO Output Function.....	164
D WATCHDOG TIMER	165
E ADDRESS MAPPING	168
E.1 DIRECT MEMORY ACCESS (DMA).....	169
E.2 INPUT/OUTPUT (IO).....	170
E.3 INTERRUPT REQUEST (IRQ).....	172
E.4 MEMORY.....	173
F COMPATIBILITY.....	174
F.1 COMPATIBLE OPERATING SYSTEMS	175
F.2 COMPATIBLE PROCESSORS.....	175
F.3 COMPATIBLE MEMORY MODULES	176

G HAZARDOUS MATERIALS DISCLOSURE 177

G.1 HAZARDOUS MATERIALS DISCLOSURE TABLE FOR IPB PRODUCTS CERTIFIED AS
ROHS COMPLIANT UNDER 2002/95/EC WITHOUT MERCURY 178

List of Figures

Figure 1-1: PPC-5xxx-9455	2
Figure 1-2: Front View	4
Figure 1-3: PPC-5xxx-9455 Rear View	5
Figure 1-4: PPC-5xxx-9455 Top View.....	5
Figure 1-5: Bottom View	6
Figure 1-6: Left View.....	7
Figure 1-7: Right View	7
Figure 1-8: Internal Components	8
Figure 2-1: PPC-5150A-9455 Dimensions (units in mm).....	20
Figure 2-2: PPC-5170A-9455 Dimensions (units in mm).....	21
Figure 2-3: PPC-5190A-9455 Dimensions (units in mm).....	22
Figure 2-4: POS-9455 Motherboard	23
Figure 2-5: SO-DIMM Socket	27
Figure 2-6: CompactFlash® Slot	28
Figure 2-7: SATA Hard Drive Slot	29
Figure 2-8: Expansion Card Slot	29
Figure 2-9: USB Ports	30
Figure 2-10: Serial Ports	31
Figure 2-11: Parallel Port	31
Figure 2-12: Ethernet.....	32
Figure 4-1: Back Cover Retention Screws	41
Figure 4-2: HDD Retention Screws	49
Figure 4-3: HDD SATA Connector.....	50
Figure 4-4: HDD Retention Screws	50
Figure 4-5: HDD Retention Screws	51
Figure 4-6: CompactFlash® Cover Plate.....	51
Figure 4-7: CompactFlash® Slot.....	52
Figure 4-8: CompactFlash® Cover Plate.....	52
Figure 4-9: CD Drive Adapter Installation	53
Figure 4-10: CD Drive Retention Screws.....	53

Figure 4-11: Optical Drive Blank Plate Assembly	54
Figure 4-12: Optical Drive Screws	55
Figure 4-13: Optical Drive SATA Cable	56
Figure 4-14: Optical Drive Bracket Screws	56
Figure 4-15: Wall-mounting Bracket	58
Figure 4-16: Mount the Chassis	59
Figure 4-17: Secure the Chassis	60
Figure 4-18: 15" Panel Cutout Dimensions.....	61
Figure 4-19: 17" Panel Cutout Dimensions.....	61
Figure 4-20: 19" Panel Cutout Dimensions.....	62
Figure 4-21: Panel Mounting Clamp Positions.....	63
Figure 4-22: Tighten the Panel Mounting Clamp Screws	63
Figure 4-23: The Rack/Cabinet Bracket.....	64
Figure 4-24: Secure the Rack/Cabinet Bracket.....	65
Figure 4-25: Install into a Rack/Cabinet	65
Figure 4-26: Arm Mount Retention Screw Holes	67
Figure 6-1: Chipset Driver Installation Program.....	125
Figure 6-2: Chipset Driver Installation Welcome Screen.....	125
Figure 6-3: Chipset Driver Installation License Agreement	126
Figure 6-4: Chipset Driver Readme File Information	126
Figure 6-5: Chipset Driver Installation Complete	127
Figure 6-6: Chipset Driver Installation Complete	128
Figure 6-7: Graphics Setup Icon	129
Figure 6-8: VGA Driver	129
Figure 6-9: Graphics Driver Installation	130
Figure 6-10: Graphics Driver License Agreement.....	130
Figure 6-11: Graphics Driver Readme file	131
Figure 6-12: Graphics Driver Installation Notice	132
Figure 6-13: Graphics Driver Installation Complete.....	132
Figure 6-14: Windows Control Panel.....	133
Figure 6-15: System Icon	134
Figure 6-16: Device Manager Tab	134
Figure 6-17: Device Manager List	135
Figure 6-18: Search Windows Update Prompt	135
Figure 6-19: Search Windows Update Prompt	136

PPC-5xxx-9455 Panel PC

Figure 6-20: Hardware Installation Complete	137
Figure 6-21: Select the Audio Codec	138
Figure 6-22: Audio Driver Installation.....	138
Figure 6-23: InstallShield Wizard Complete.....	139
Figure 6-24: S-Video Patch Folder	140
Figure 6-25: Touch Panel Driver Welcome Screen	140
Figure 6-26: Touch Panel License Agreement	141
Figure 6-27: Touch Panel Installation Directory	141
Figure 6-28: Touch Panel Drivers Installing	142
Figure 6-29: Windows Logo Testing.....	142
Figure 6-30: InstallShield Wizard Complete.....	143
Figure 7-1: DIMM Socket Clip Locations	147
Figure 7-2: Top Panel Elevated Platform Screws.....	147
Figure 7-3: Side Panel Elevated Platform Screws.....	148
Figure 7-4: Bottom Panel Elevated Platform Screws.....	148
Figure 7-5: Internal Elevated Platform Screws.....	149
Figure 7-6: PSU Power Cables	150
Figure 7-7: PSU Bottom Panel Retention Screws	150
Figure 7-8: PSU Rear Panel Screws.....	151
Figure 7-9: System Cooling Fans Motherboard Connector	152
Figure 7-10: System Cooling Fans Left Panel Retention Screws.....	153

List of Tables

Table 1-1: PPC-5xxx-9455 Model Variations	3
Table 2-1: PPC-5xxx-9455 Specifications	12
Table 2-2: Motherboard Specifications	13
Table 2-3: 15" TFT LCD Monitor Specifications	14
Table 2-4: 17" TFT LCD Monitor Specifications	15
Table 2-5: 19" TFT LCD Monitor Specifications	16
Table 2-6: ACE-A618A Power Supply Specifications	17
Table 2-7: ACE-4520C Power Supply Specifications	18
Table 2-8: ACE-A618A Power Supply Specifications	19
Table 3-1: Package List Contents	37
Table 4-1: Onboard Jumpers.....	43
Table 4-2: AT/ATX Power Selection.....	43
Table 4-3: Clear CMOS Jumper Settings.....	44
Table 4-4: LCD Resolution Settings.....	44
Table 4-5: Monitor Settings	44
Table 4-6: CF Card Setup Jumper Settings	45
Table 4-7: COM1 RI and Voltage Selection Jumper	45
Table 4-8: COM2 RI and Voltage Selection Jumper	45
Table 4-9: COM3 RI and Voltage Selection Jumper	45
Table 4-10: COM4 RI and Voltage Selection Jumper	46
Table 4-11: COM5 RI and Voltage Selection Jumper	46
Table 4-12: COM5 RS-232/422/485 RX Select	46
Table 4-13: COM5 RS-422/485 TX Select	46
Table 4-14: COM5 RS-422/485 TX Select	47
Table 4-15: COM5 RS-422/485 TX Select	47
Table 4-16: RS-422 Pinouts	47
Table 4-17: RS-485 Pinouts	47
Table 4-18: LCD Voltage Settings	48
Table 4-19: Touch Screen Selection.....	48
Table 5-1: BIOS Navigation Keys.....	71

BIOS Menus

BIOS Menu 1: Main	72
BIOS Menu 2: Advanced	74
BIOS Menu 3: CPU Configuration	75
BIOS Menu 4: IDE Configuration	77
BIOS Menu 5: IDE Master and IDE Slave Configuration	79
BIOS Menu 6: IDE Master and IDE Slave Configuration	84
BIOS Menu 7: Super IO Configuration	85
BIOS Menu 8: Hardware Health Configuration	90
BIOS Menu 9: ACPI Configuration	95
BIOS Menu 10: ACPI Configuration	96
BIOS Menu 11: Advanced Power Management Configuration	97
BIOS Menu 12: Remote Access Configuration [Advanced]	100
BIOS Menu 13: USB Configuration	103
BIOS Menu 14: USB Mass Storage Device Configuration	105
BIOS Menu 15: PCI/PnP Configuration	107
BIOS Menu 16: Boot	109
BIOS Menu 17: Boot Settings Configuration	110
BIOS Menu 18: Boot Device Priority Settings	112
BIOS Menu 19: Hard Disk Drives	113
BIOS Menu 20: CD/DVD Drives	115
BIOS Menu 21: Security	116
BIOS Menu 22: Chipset	117
BIOS Menu 23: Northbridge Chipset Configuration	118
BIOS Menu 24: Southbridge Chipset Configuration	120
BIOS Menu 25: Exit	121

Chapter

1

Introduction

1.1 General Overview



Figure 1-1: PPC-5xxx-9455

The PPC-5xxx-9455 flat panel PC is for industrial environments like production lines and machine automation. The PPC-5xxx-9455 provides all the features of a PC, combined with a touch panel screen for mouse and keyboard free data input. The PPC-5xxx-9455 provides wired and, optionally, wireless networking for integration into company networks. All major external device connections including USB, serial and parallel port connectors. Storage options include a 2.5" hard drive and a CompactFlash® slot, allowing for flexibility in choosing solid state drives or traditional hard drives. A VGA output on the rear panel allows the PPC-5xxx-9455 to connect to a second screen for duplicating the screen contents or extending the user interface.

PPC-5xxx-9455 Panel PC

1.1.1 Model Variations

Four IEI PPC-5xxx-9455 models are available. The models are listed in **Table 1-1**.

Model	Socket / CPU	Power	Screen	Touch Screen
PPC-5150A-R11/9455-E2160/A618A/T-R/1GB	LGA775	AC input	15"	Yes
PPC-5150A-R11/9455-E2160/4520C/T-R/1GB		24 V DC input	15"	
PPC-5170A-R11/9455-E2160/A622A/T-R/1GB	1.8 GHz Intel® Pentium®	AC input	17"	
PPC-5170A-R11/9455-E2160/4520C/T-R/1GB		24 V DC input	17"	
PPC-5190A-R11/9455-E2160/A622A/T-R/1GB	E2160	AC input	19"	
PPC-5190A-R11/9455-E2160/4520C/T-R/1GB		24 V DC input	19"	

Table 1-1: PPC-5xxx-9455 Model Variations

1.1.2 Applications

The PPC-5xxx-9455 flat panel PC is designed for rigorous industrial environments where it may be exposed to both heat and moisture. Its durability and strength also makes it an ideal choice for public access computers. Some possible applications include:

- Automated manufacturing processes
- Public information gathering point
- Plant environment monitoring system
- Factory automation
- Manufacturing shop flow
- Equipment and device control

1.1.3 Features

Some of the features of the PPC-5xxx-9455 flat panel PC include:

- Mainstream panel PC design with dual display function.
- Aluminum die-casting front panel meet IP 65 water proof standard
- Support LGA775 Intel® Pentium® processor E2160 with 800 MHz FSB
- Dual DDR memory DIMM support up to 2 GB SDRAM
- SATA connectors

- High brightness industrial grade LCD panel
- The following I/O ports
 - 5 x COM (1 for Touch Screen)
 - 4 x USB 2.0 ports
 - 1 x PCI slot
 - 1 x CompactFlash® slot
 - 1 x VGA port
 - 1 x Parallel port
- Dual 10/100/Gigabit Ethernet supported
- RoHS compliant

1.2 External Overview

The PPC-5xxx-9455 flat panel PC is comprised of an LCD screen, aluminum front panel and heavy duty steel rear and side panels. The rear panel provides screw holes for wall and an arm mounting. The right panel provides access to a slim type CD drive bay and a floppy disk drive bay. The bottom panel provides access to external interface connectors that include GbE, USB 2.0, audio, parallel port, serial port connectors, VGA port, PCI card slot and a CompactFlash® card slot.

1.2.1 Front Panel

The front panel of the PPC-5xxx-9455 (Figure 1-2) is a flat panel TFT LCD screen surrounded by an aluminum frame.

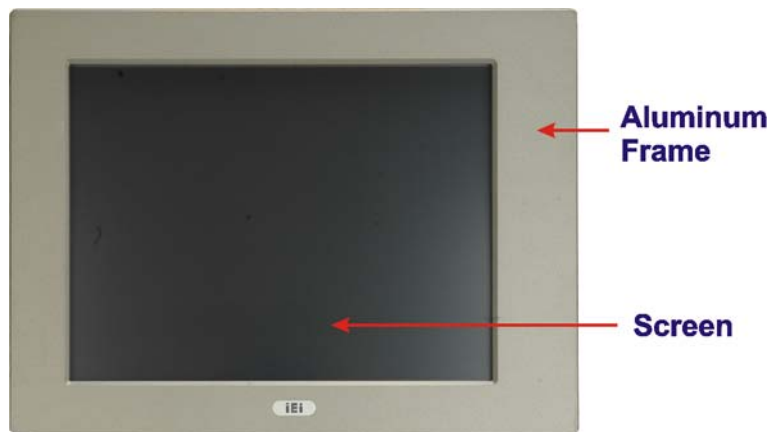

Figure 1-2: Front View

PPC-5xxx-9455 Panel PC

1.2.2 Rear Panel

The rear panel has a fan vent, four VESA standard mounting holes and several retention screw holes. The VESA mounting holes are circled in Figure 1-3.

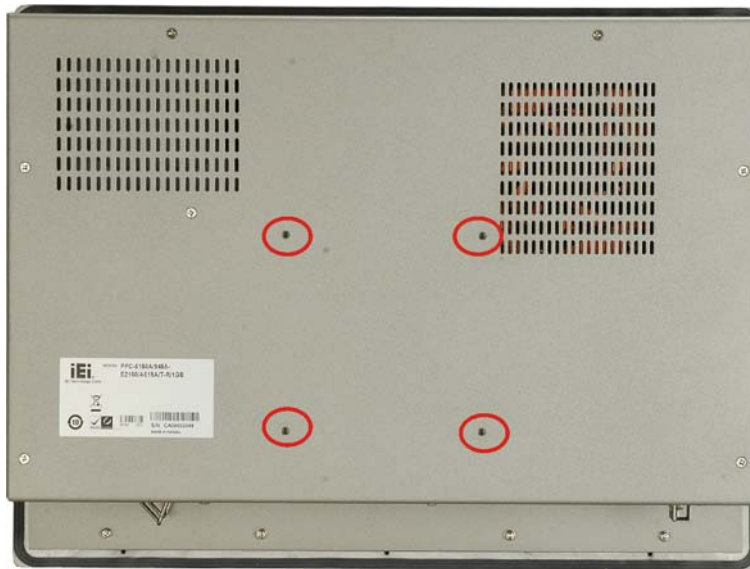

Figure 1-3: PPC-5xxx-9455 Rear View

1.2.3 Top Panel

The top panel has two fan vents, eight mounting clamp slots and three retention screws for securing the drive bay bracket. The retention screws are circled in Figure 1-4 below.

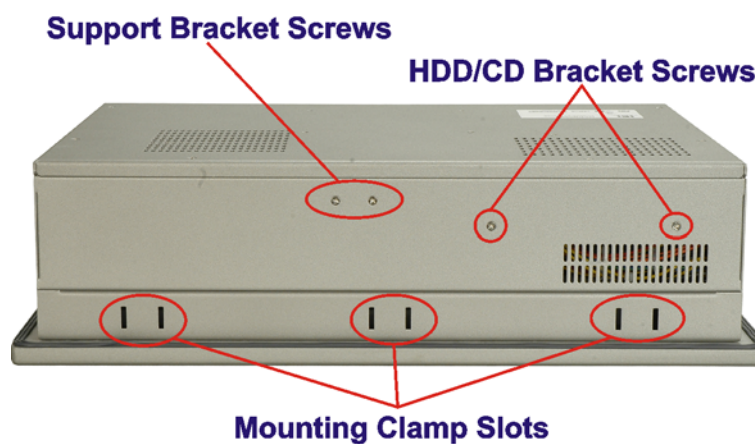

Figure 1-4: PPC-5xxx-9455 Top View

1.2.4 Bottom Panel

The bottom panel shown in Figure 1-5 has the following interfaces:

- 1 x Power input connector
- 1 x Power switch
- 4 x USB connectors
- 1 x Reset button
- 2 x RJ-45 GbE connectors
- 1 x PS/2 mouse connector
- 1 x PS/2 keyboard connector
- 5 x Serial port (COM) connectors
- 1 x PCI add-on card slot
- 1 x Parallel port connector
- 3 x Audio jacks
- 1 x VGA connector
- 1 x CompactFlash® slot

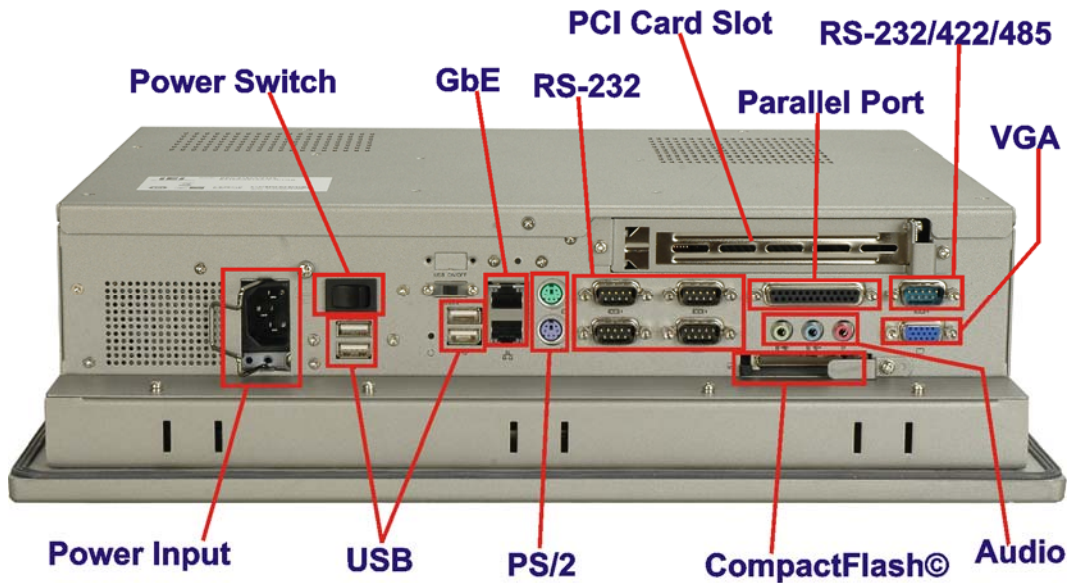

Figure 1-5: Bottom View

PPC-5xxx-9455 Panel PC

1.2.5 Left Panel

The left side panel has two fan vents and four retention screws for securing the two internal fans. The retention screws are circled in Figure 1-6.

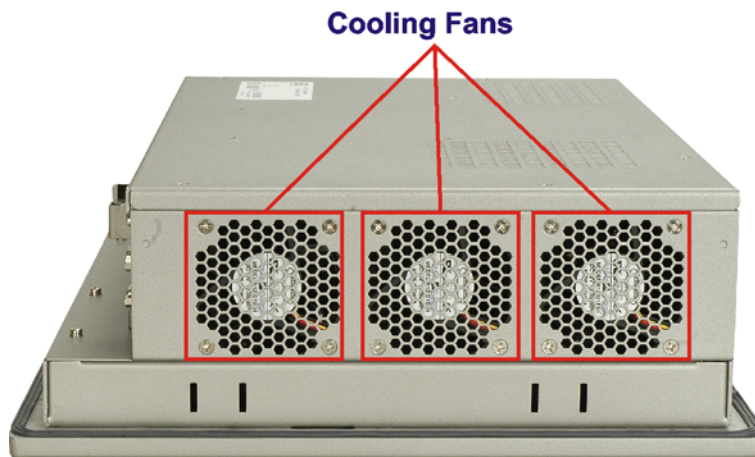

Figure 1-6: Left View

1.2.6 Right Panel

The right side panel provides access to a slim type CD drive bay and a FDD drive bay shown in Figure 1-7.

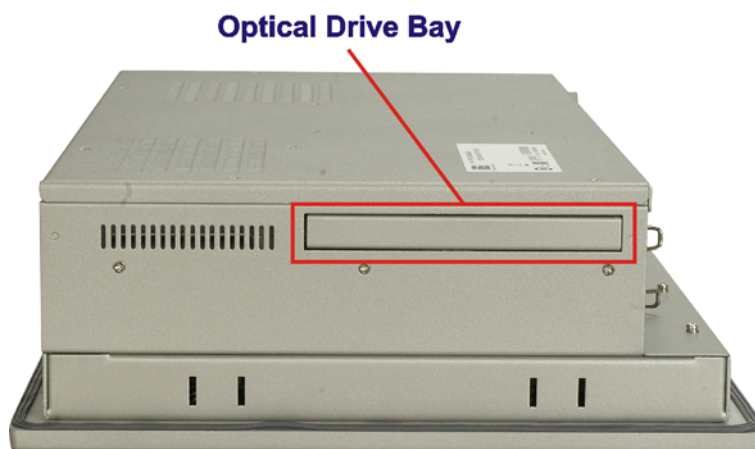

Figure 1-7: Right View

1.3 Internal Overview

The PPC-5xxx-9455 internal components are configured in three levels. The PSU cover bracket to the left (Figure 1-8) supports the hard drive and optical drive brackets. Below the PSU cover bracket is the power supply. On the same level as the power supply is the motherboard. Below the motherboard and PSU level is an LCD panel. An overview picture of the internal components is shown in Figure 1-8 below.

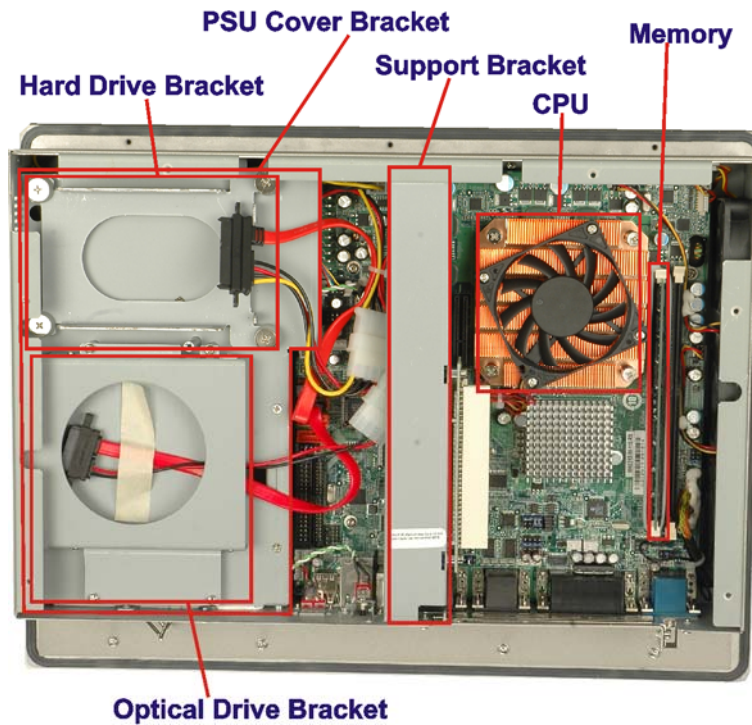

Figure 1-8: Internal Components

Chapter

2

Specifications

2.1 Introduction

The PPC-5xxx-9455 flat panel PC has the following preinstalled components:

- 1 x Motherboard
- 1 x TFT LCD screen
- 1 x Power supply
- 2 x Cooling fans

The technical specifications for these components and the system are shown in the sections below.

2.1.1 System Specifications

The technical specifications for the PPC-5xxx-9455 system are listed in Table 2-1.

SPECIFICATION	DESCRIPTION
Front Panel	Aluminum Front Panel meets IP 65 standard
Chassis	Heavy-duty Steel
LCD Panel	High luminance TFT LCD
Resolution	PPC-5150A-9455: 1024 x 768 (XGA) PPC-5170A-9455: 1280 x 1024 (SXGA) PPC-5190A-9455: 1280 x 1024 (SXGA)
Brightness	PPC-5150A-9455: 350 cd/m ² PPC-5170A-9455: 300 cd/m ² PPC-5190A-9455: 300 cd/m ²
Contrast Ratio	PPC-5150A-9455: 700:1 PPC-5170A-9455: 800:1 PPC-5190A-9455: 800:1
LCD MTBF	50,000 hrs
Backlight MTBF	50,000 hrs
Viewing Angle (H/V)	PPC-5150A-9455: 140/125 PPC-5170A-9455: 160/160 PPC-5190A-9455: 160/160

PPC-5xxx-9455 Panel PC

SPECIFICATION	DESCRIPTION
Touch Screen	Optional 5-wire resistive type touch screen with RS-232 interface
Display	Supports Dual Display
Add-On Card (Optional)	One PCI card
Drive Bay	One 2.5" HDD bay with anti-shock One slim type CD drive bay One slim type FDD bay One CompactFlash® slot
Power Supply	Input voltage: 90~265 V AC, 50~60 Hz Output rating: 180 W Output voltage: +3.3 V @ 16.8A +5 V @ 12A +12 V @ 10A -12 V @ 0.8A +5 VSB @ 2A
	Input voltage: 24 VDC (18-36 VDC) Output rating: 200 W Output voltage: +3.3 V @ 12A +5 V @ 12A +12 V @ 15.4A -12 V @ 0.5A +5 VSB @ 2A
Mounting Feature	Panel, Arm, Wall, or Rack/Cabinet
Color	Silver (PANTONE PMS-8001)
Operating Temperature	0~50°C
Relative Humidity	5 ~ 85%, non-condensing
Vibration	5 - 17Hz, 0.1" double amplitude displacement 17 - 640Hz, 1.5G acceleration, peak to peak

SPECIFICATION	DESCRIPTION
Shock	10G Acceleration, peak to peak (11ms)
Dimensions (W x D x H)	PPC-5150A-9455: 410 mm x 309 mm x 110.5 mm PPC-5170A-9455: 452 mm x 356 mm x 115 mm PPC-5190A-9455: 483 mm x 399 mm x 115.2 mm
Net/Gross Weight	PPC-5150A-9455: 7 kg/11 kg PPC-5170A-9455: 8 kg/12 kg PPC-5190A-9455: 12.6 kg/18.2 kg
Environment	RoHS Compliant

Table 2-1: PPC-5xxx-9455 Specifications

2.1.2 Motherboard Specifications

The PPC-5xxx-9455 comes with a POS-9455 motherboard. The technical specifications of the motherboard are listed in Table 2-2.

SPECIFICATION	DESCRIPTION
CPU	LGA775 Intel® Pentium® processor E2160 (1M Cache, 1.80 GHz, 800 MHz FSB)
Northbridge	Intel® 945G
Southbridge	Intel® ICH7
Max. FSB	800 MHz
Memory	2 x 2.0 GB (max) 400/533/667 MHz DDR2 DIMM sockets up to 4.0 GB (total)
BIOS	AMI BIOS Label
Display	CRT integrated in Intel® 945G LVDS Dual 18/24-bit TTL LCD implemented through a Chrontel CH7308B LVDS chipset
Expansion Interface	1 x PCI slot 1 x PCIe slot
Audio	HD Audio

PPC-5xxx-9455 Panel PC

SPECIFICATION	DESCRIPTION
Ethernet	2 x Realteck RTL8111CP GbE controller
COM	1 x RS-232/422/485 port 5 x RS-232 ports (1 used internally for touch screen)
USB 2.0	6 x USB 2.0 ports
Drive Interfaces	2 x SATA drive connectors
LPT	1 x Parallel port
KB/ MS	2 x PS/2 connector
IrDA	1 x IrDA interface

Table 2-2: Motherboard Specifications

2.1.3 Flat Panel Screen

The PPC-5xxx-9455 comes with a flat panel TFT LCD screen. Screen specifications for each model are detailed below.

2.1.3.1 PPC-5150A-9455 Screen

The PPC-5150A-9455 comes with a 15" TFT LCD monitor at the front of the flat panel PC. The specifications for the LCD monitor are shown in Table 2-3 below.

SPECIFICATION	DETAILS
Model	AUO-G150XG01
Size	15"
Resolution	XGA (1024 x 768)
Active Area (mm)	304.1 x 228.1
Pixel Pitch (mm)	0.297
Mode	TN
Number of Colors	262K
Color Saturation (%)	60
View Angel (H/V)	120/100

SPECIFICATION	DETAILS
Brightness (cd/m ²)	350
Contrast Ratio	400:1
Response Time (ms) (at 25°C)	16
Power Consumption (W)	11.5
Interface	1ch LVDS
Supply Voltage (V)	3.3
Backlight	2 CCFL
Outline Dimensions (mm)	326.5 x 253.5 x 12.0
Weight (g)	1100

Table 2-3: 15" TFT LCD Monitor Specifications

2.1.3.2 PPC-5170A-9455 Screen

The PPC-5170A-9455 comes with a 17" TFT LCD monitor at the front of the flat panel PC. The specifications for the LCD monitor are shown in Table 2-4 below.

SPECIFICATION	DETAILS
Model	AUO-M170EG01 V8
Size	17"
Resolution	SXGA (1280 x 1024)
Active Area (mm)	337.9 x 270.3
Pixel Pitch (mm)	0.264
Mode	TN
Number of Colors	16.2M
Color Saturation (%)	72
View Angel (H/V)	140 / 130
Brightness (cd/m ²)	300
Contrast Ratio	500 : 1

PPC-5xxx-9455 Panel PC

SPECIFICATION	DETAILS
Response Time (ms) (at 25°C)	8
Power Consumption (W)	25.8
Interface	2ch LVDS
Supply Voltage (V)	5
Backlight	4 CCFL
Outline Dimensions (mm)	358.5 x 296.5 x 17.0
Weight (g)	1900

Table 2-4: 17" TFT LCD Monitor Specifications

2.1.3.3 PPC-5190A-9455 Screen

The PPC-5190A-9455 comes with a 19" TFT LCD monitor at the front of the flat panel PC.

The specifications for the LCD monitor are shown in Table 2-5 below.

SPECIFICATION	DESCRIPTION
Model	AUO-M190EG02
Size	19"
Resolution	SXGA (1280 x 1024)
Active Area (mm)	376.32 x 301.06
Pixel Pitch (mm)	0.294
Mode	TN
Number of Colors	16.2M
Color Saturation (%)	72
View Angel (H/V)	160 / 160
Brightness (cd/m2)	300
Contrast Ratio	700 : 1
Response Time (ms) (at 25°C)	6
Power Consumption (W)	28

SPECIFICATION	DESCRIPTION
Interface	2ch LVDS
Supply Voltage (V)	5
Backlight	4 CCFL
Outline Dimensions (mm)	396.0 x 324.0 x 17.5
Weight (g)	2500

Table 2-5: 19" TFT LCD Monitor Specifications

2.1.4 Power Supply

The PPC-5xxx-9455 flat panel PC comes with either an ACE-A618A 180 W 1U, ACE-4520C 200 W DC 1U or ACE-A622A 220 W 1 U RoHS compliant ATX power supply. The PSUs have an MTBF greater than 100,000 hours.



WARNING:

Under no circumstances is the PSU case to be opened. The PSU module is not user serviceable and there are dangerous high-voltages inside the case. If there are any problems with the PSU module, please contact the dealer or reseller immediately.

2.1.4.1 ACE-A618A Power Supply

Specifications for the ACE-A618A PSU module are shown in (Table 2-6).

Specification		Rating				
INPUT	Voltage	90 V ~ 264 VAC Full Range				
OUTPUT	Voltage (V)	+3.3 V	+5 V	+12 V	-12 V	5 VSB
	Min. Load (A)	0.3A	0.3A	1.5A	0A	0A
	Max. Load (A)	14A	16A	14A	0.5A	2A
GENERAL	Watt	180 W				
	Efficiency	68%				
	MTBF	100,000hrs				
	Temperature	0~50°C (Operating) -20~80°C (Storage)				
	Humidity	5 –95% RH, Non-condensing (Operating & Storage)				
	Dimension	150 mm (W) x 81.5 mm (H) x 40.5 mm (D)				

Table 2-6: ACE-A618A Power Supply Specifications

2.1.4.2 ACE-4520C Power Supply

Specifications for the ACE-4520C PSU module are shown in (Table 2-7).

Specification		Rating
INPUT	Voltage	18 VDC ~ 36 VDC Full Range
	Input Current	15A
	Inrush Current	100A

Specification		Rating				
OUTPUT	Voltage (V)	+3.3 V	+5 V	+12 V	-12 V	5 VSB
	Min. Load (A)	0.0A	1.0A	0.5A	0.0A	0.0A
	Max. Load (A)	12A	12A	15.4A	0.5A	2.0A
	Ripple and Noise (mV)	50mV	50mV	120mV	120mV	50mV
	+3.3 V & +5 V \leq 80 W; +3.3 V & +5 V & +12 V \leq 184 W					
GENERAL	Watt	200 W				
	PFC	Active				
	Hold-up time	20ms minimum				
	Efficiency	78%				
	MTBF	100,000hrs				
	Temperature	0~50°C (Operating); -20~80°C (Storage)				
	Humidity	5 –95% RH, Non-condensing (Operating & Storage)				
	Dimension	150 mm (W) x 81.5 mm (H) x 40.3 mm (D)				

Table 2-7: ACE-4520C Power Supply Specifications

2.1.4.3 ACE-A622A Power Supply

Specifications for the ACE-A622A PSU module are shown in (Table 2-8).

Specification		Rating					
INPUT	Voltage	90 V ~ 264 VAC Full Range					
OUTPUT	Voltage (V)	+3.3 V	+5 V	+12 V	-5 V	-12 V	5 VSB
	Min. Load (A)	0.5A	0.5A	1A	1A	0A	0A
	Max. Load (A)	14A	16A	16A	10A	0.8A	2.5A
GENERAL	Watt	220 W					
	Efficiency	80%					
	MTBF	100,000hrs					
	Temperature	0~50°C (Operating) -20~80°C (Storage)					
	Humidity	5 –95% RH, Non-condensing (Operating & Storage)					
	Dimension	150 mm (W) x 81.5 mm (H) x 40.5 mm (D)					

Table 2-8: ACE-A618A Power Supply Specifications

2.2 Dimensions

The dimensions of the PPC-5xxx-9455 are shown in the sections below.

2.2.1 PPC-5150A-9455 Dimensions

The dimensions of the PPC-5150A-9455 flat panel PC are shown in Figure 2-1 below.

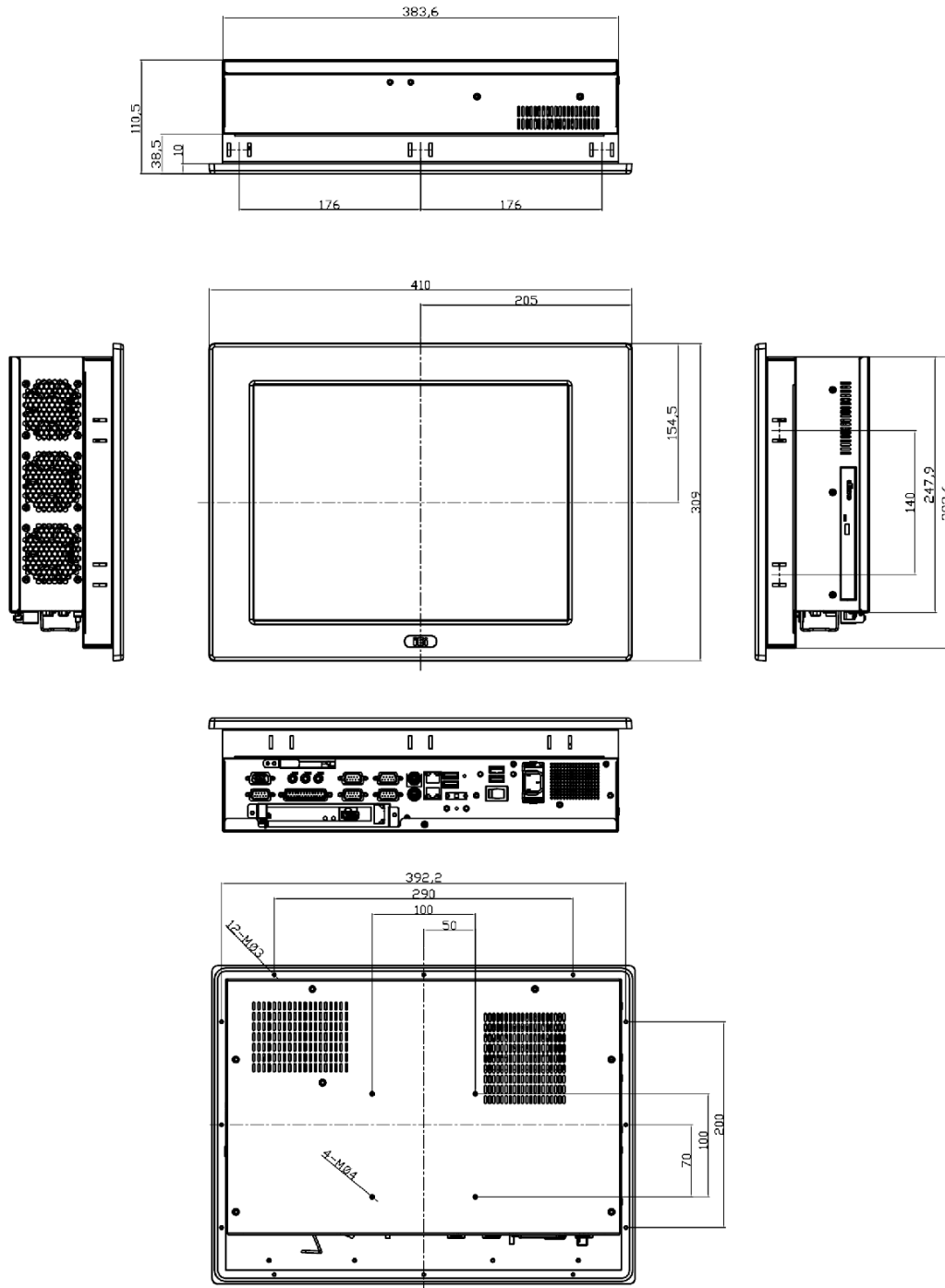

Figure 2-1: PPC-5150A-9455 Dimensions (units in mm)

PPC-5xxx-9455 Panel PC

2.2.2 PPC-5170A-9455 Dimensions

The dimensions of the PPC-5170A-9455 flat panel PC are shown in Figure 2-2 below.

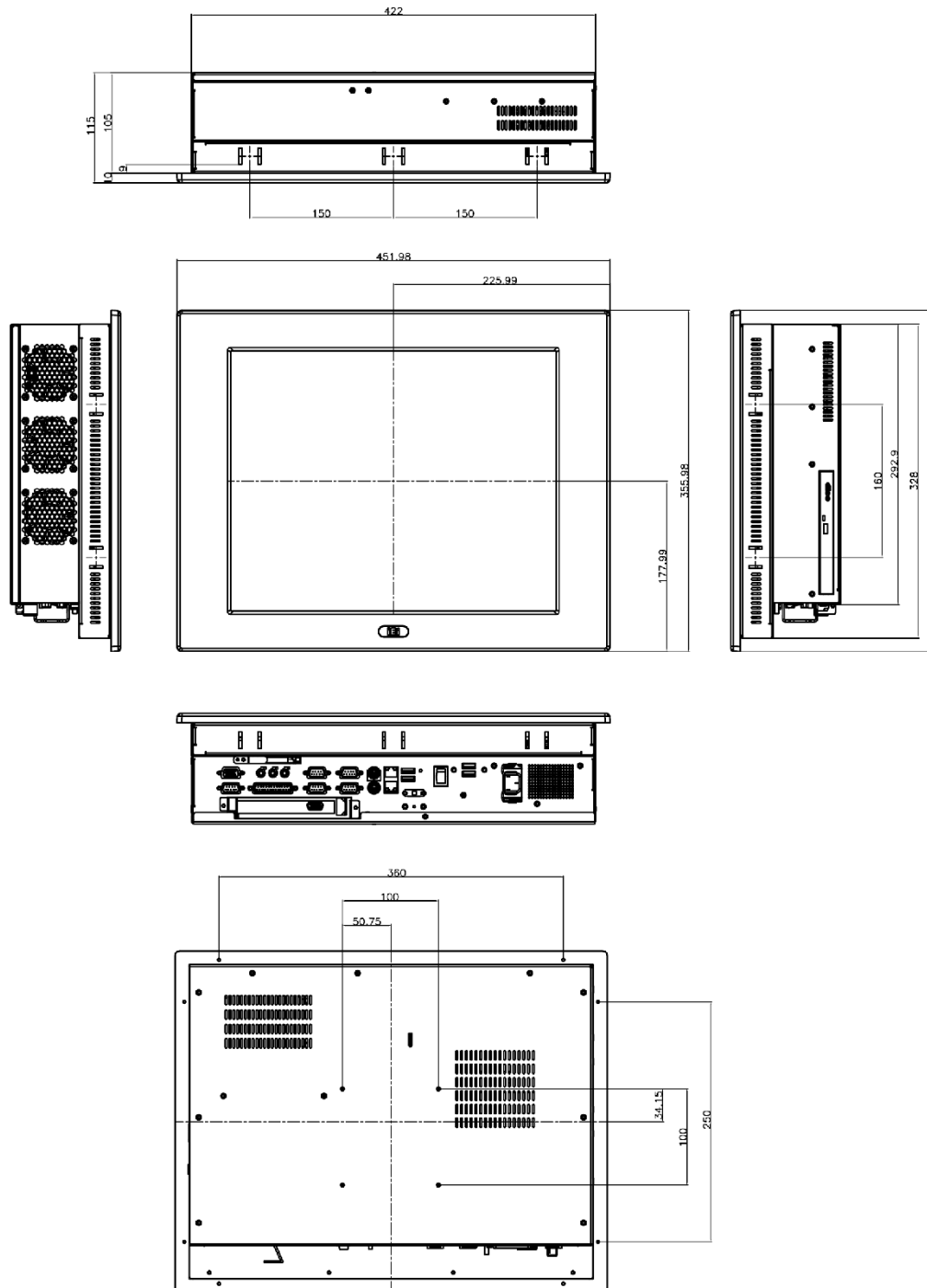

Figure 2-2: PPC-5170A-9455 Dimensions (units in mm)

2.2.3 PPC-5190A-9455 Dimensions

The dimensions of the PPC-5190A-9455 flat panel PC are shown in Figure 2-3 below.

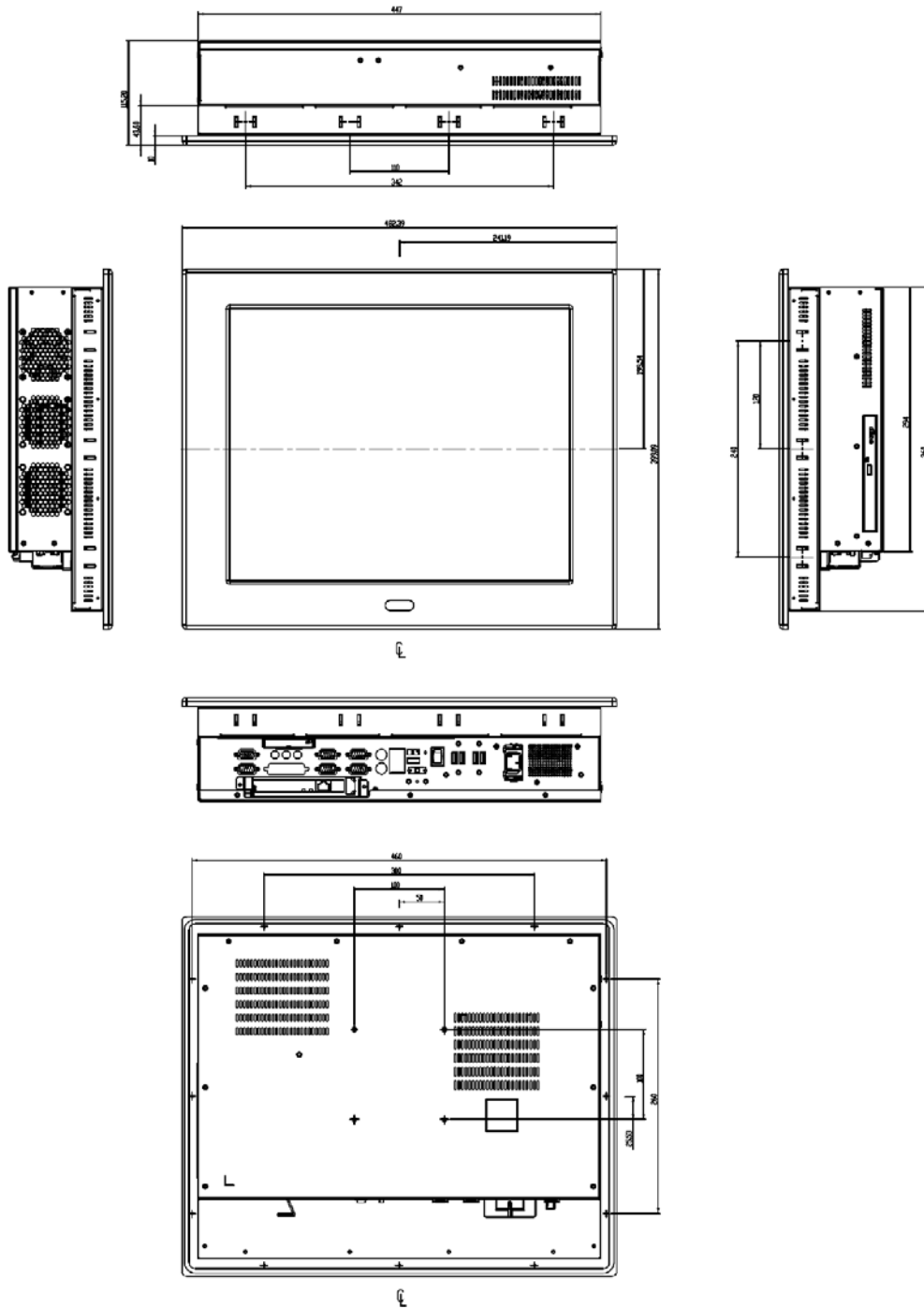

Figure 2-3: PPC-5190A-9455 Dimensions (units in mm)

PPC-5xxx-9455 Panel PC

2.3 Motherboard

The PPC-5xxx-9455 flat screen PC contains a POS-9455 motherboard. The motherboard is the heart of any computer and is responsible for transmitting, receiving and processing data as well as driving the different on-board devices. This chapter gives a brief introduction to the POS-9455 motherboard. For more complete details on the connectors and the different implementations of the POS-9455, please refer to the POS-9455 user manual.

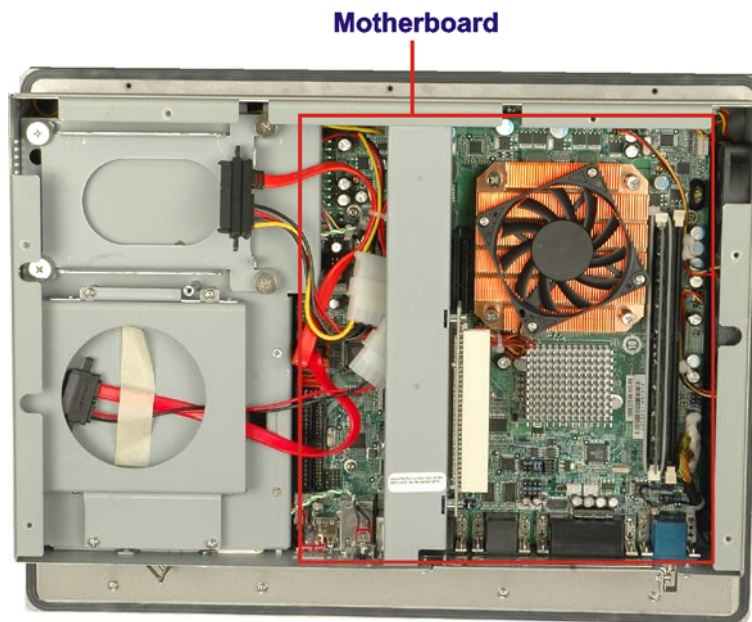

Figure 2-4: POS-9455 Motherboard

2.4 CPU Support

The PPC-5xxx-9455 panel PC is preinstalled with a LGA775 1.8 GHz Intel® Pentium® processor E2160.

2.5 System Chipsets

The following chipsets are preinstalled on the board:

- **Northbridge:** Intel® 945G
- **Southbridge:** Intel® ICH7

Specifications of these two chipsets are listed in the subsections below.

2.5.1 Intel® 945G Northbridge Chipset

The Intel® 945G Northbridge chipset comes with the following features:

- Supports the Intel Pentium 4 processor and Intel Celeron processor with Intel NetBurst® microarchitecture
- 400 MHz or 533 MHz system bus delivers a high-bandwidth connection between the processor and the platform
- Integrated graphics utilizing Intel® Extreme Graphics 2 technology
- Display
 - Analog display support
 - Dual independent pipe support
 - DVO (DVOB and DVOC) support
 - Dedicated Local Flat Panel (LFP) LVDS interface
- Intel® Embedded Graphics Drivers
 - Graphics interface support
 - Multi-monitor support
 - Dynamic display-mode support
 - Embedded video BIOS

2.5.2 ICH7 Southbridge Chipset

The ICH7 Southbridge chipset comes with the following features:

- PCI Bus Interface
 - New: Supports PCI Revision 2.3 Specification at 33 MHz
 - 6 available PCI REQ/GNT pairs
 - One PCI REQ/GNT pair can be given higher arbitration priority (intended for external 1394 host controller)
 - Support for 44-bit addressing on PCI using DAC protocol
- Integrated LAN Controller
 - Integrated ASF Management Controller
 - WfM 2.0 and IEEE 802.3 Compliant
 - LAN Connect Interface (LCI)
 - 10/100/1000 Mbit/sec Ethernet Support

PPC-5xxx-9455 Panel PC

- Integrated Serial ATA Host Controllers
 - Independent DMA operation on two ports.
 - Data transfer rates up to 1.5 Gb/s (150 MB/s).
- Integrated IDE Controller
 - Supports “Native Mode” Register and Interrupts
 - Independent timing of up to 4 drives
 - Ultra ATA/100/66/33, BMIDE and PIO modes
 - Tri-state modes to enable swap bay
- Interrupt Controller
 - Supports up to 8 PCI interrupt pins
 - Supports PCI 2.3 Message Signaled Interrupts
 - Two cascaded 82C59 with 15 interrupts
 - Integrated I/O APIC capability with 24 interrupts
 - Supports Front Side Bus interrupt delivery
- High-Precision Event Timers
- 1.5 V operation with 3.3 V I/O
 - 5 V tolerant buffers on IDE, PCI, USB Overcurrent and Legacy signals
- Integrated 1.5 V Voltage Regulator (INTVR) for the Suspend wells
- Enhanced DMA Controller
 - Two cascaded 8237 DMA controllers
 - PCI DMA: Supports PC/PCI — Includes two PC/PCI REQ#/GNT# pairs
 - Supports LPC DMA
 - Supports DMA Collection Buffer to provide Type-F DMA performance for all DMA channels
- Real-Time Clock
 - 256-byte battery-backed CMOS RAM
 - Integrated oscillator components
 - Lower Power DC/DC Converter implementation

2.6 Graphics Support

The ATi M690T Northbridge chipset has an integrated graphics engine that supports the following display devices:

- Analog CRT
- Digital LVDS

2.6.1 Analog CRT Support

The VGA port connects a peripheral monitor to the PPC-5xxx-9455 system. A DB-15 VGA connector on the external peripheral interface connector panel is interfaced to the Intel® 945G Northbridge. The Intel® 945G supports analog CRT monitors with the following features:

- Supports max DAC frequency up to 400 MHz
- 24-bit RAMDAC support
- DDC2B compliant
- Up to 2048 x 1536 mode support

2.6.2 LVDS Support

The LVDS connector drives the built-in LCD panel. The 30-pin LVDS crimp connector is connected to the Chrontel CH7308B chipset, which is connected to the Intel® 945G through the SDVO interface.

- 18/24-bit outputs
- Up to 140 megapixels per second

2.7 Memory

All processors supported by the PPC-5xxx-9455 have their own internal DDR2 memory controller. The DDR2 controller has the following features:

- Low-latency, high-bandwidth
- 800 MHz 128-bit DDR2 SDRAM controller
- Supports one un-buffered DDR2 SO-DIMM
- Each SO-DIMM has a maximum capacity of 1.0 GB

The DDR2 controller on the processor is interfaced to one SO-DIMM socket on the PPC-5xxx-9455.

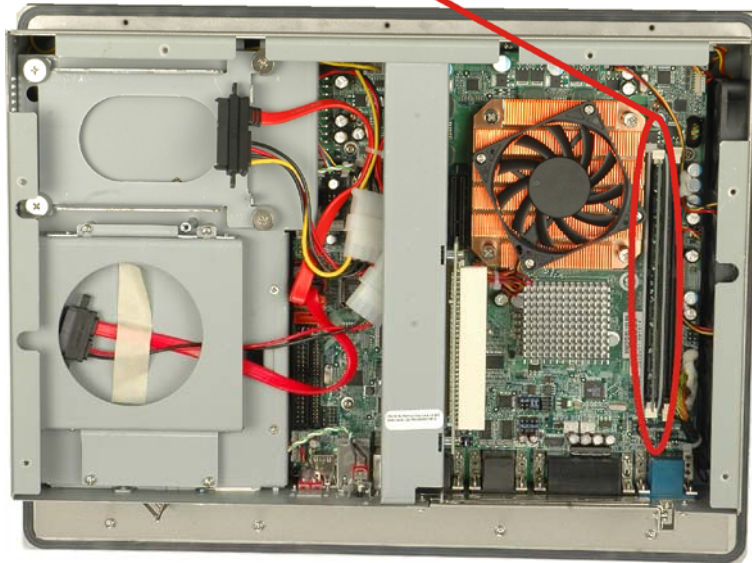
Memory**Figure 2-5: SO-DIMM Socket**

2.8 Storage

The following storage options are available:

- CompactFlash®
- SATA hard drive

2.8.1 CompactFlash®

The CompactFlash® socket supports standard CompactFlash® Type I and CompactFlash® Type II cards. The chipset flash interface is multiplexed with an IDE interface and can be connected to an array of industry standard NAND Flash or NOR Flash devices. The CompactFlash® slot location is shown below.

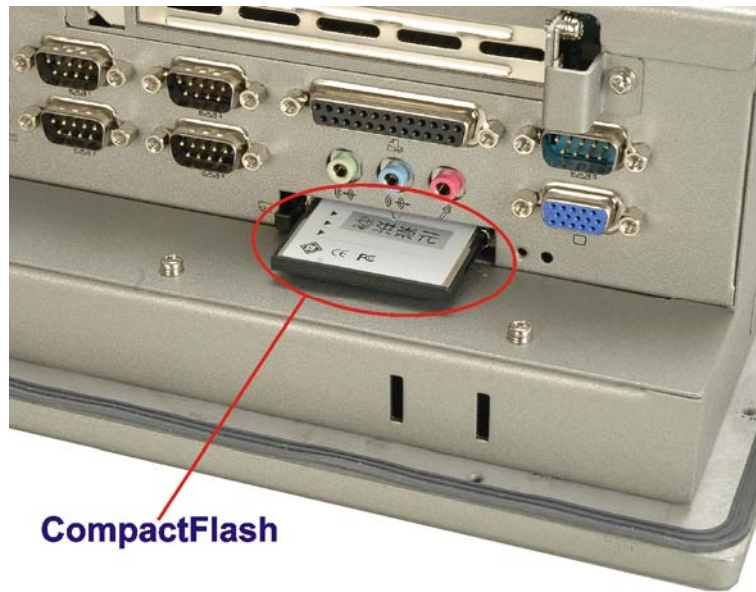

Figure 2-6: CompactFlash® Slot

2.8.2 SATA Hard Drive

The integrated SATA controller supports two SATA drives with independent DMA operations. One SATA port is implemented internally for the internal 2.5" SATA hard drive. The second SATA port is implemented on the external connector panel through an eSATA connector. SATA controller specifications are listed below.

- Supports two SATA drives
- Supports 3.0 Gb/s data transfer speeds
- Supports Serial ATA Specification, Revision 1.0a

Hard Drive

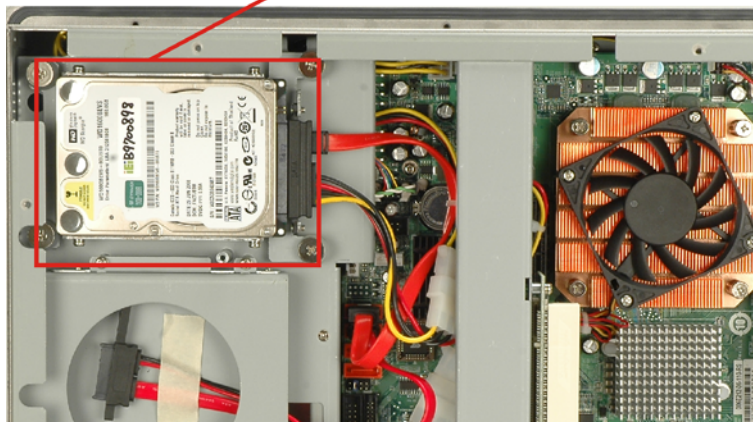

Figure 2-7: SATA Hard Drive Slot

2.9 Expansion Slots

The PPC-5xxx-9455 includes either a PCI or PCIe x4 expansion card slot. The expansion card slots add additional functionality to the PPC-5xxx-9455.

Expansion Card Interface **Expansion Card Slot Cover**

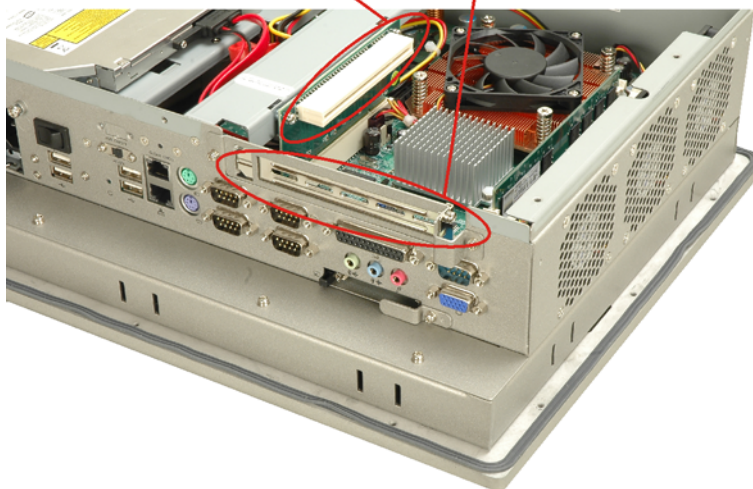

Figure 2-8: Expansion Card Slot

PCI cards available for the PPC-5xxx-9455 include:

- SCSI adapter cards

- Ethernet adapter cards
- Modem cards
- Sound cards

PCIe x4 cards available for the PPC-5xxx-9455 include:

- Gigabit Ethernet adapter cards
- SATA 3.0Gb/s or RAID controller cards
- TV tuner cards
- Graphics cards
- Firewire & USB cards

2.10 External Device Connectors

The external device connectors allow external components to be attached to the PPC-5xxx-9455. The external communications device connectors are shown in the sections below.

2.10.1 USB 2.0 Ports

USB connections provide fast data transmission to external devices including USB flash disks.



Figure 2-9: USB Ports

Some of the features of the USB ports include

- USB 2.0 compliant
- Support for low speed (1.5 Mb/s), full speed (12 Mb/s) and hi-speed (480 Mb/s) USB devices
- Hotplugging capabilities

2.10.2 Serial Ports

Serial ports provide communications to external devices. Four of the external serial ports provide short-range communications, while one provides for longer range communication.

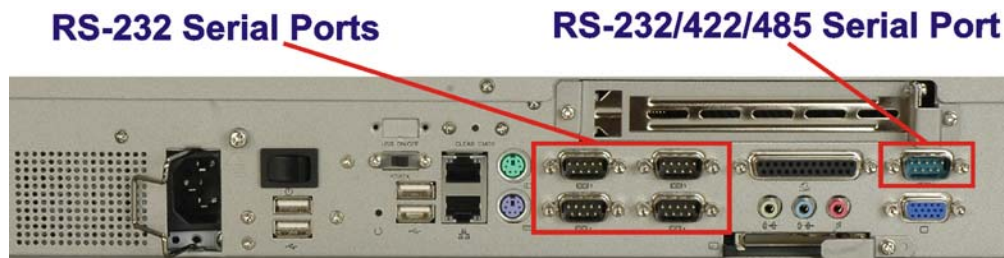

Figure 2-10: Serial Ports

Some features of the serial ports include:

- RS-232 transmission protocol for easy connection to devices with a standard RS-232 interface
- RS-422 and RS-485 transmission capabilities for longer distance connections.

2.10.3 Parallel Port

The parallel port can be programmed for machine control, or used in the standard setup for parallel port printers and other devices that use a standard parallel port.



Figure 2-11: Parallel Port

Some of the features of the parallel port include:

- Programmable pin functions for customized applications

- Standard setup connects to devices with a standard parallel port, like printers

2.11 Gigabit Ethernet

The Realtek RTL8111CP PCI Express (PCIe) GbE controller is a 10/100/1000BASE-T Ethernet LAN controller. The RTL8111CP combines a triple-speed IEEE 802.3 compliant Media Access Controller (MAC) with a triple-speed Ethernet transceiver, a PCIe bus interface, and an embedded memory.

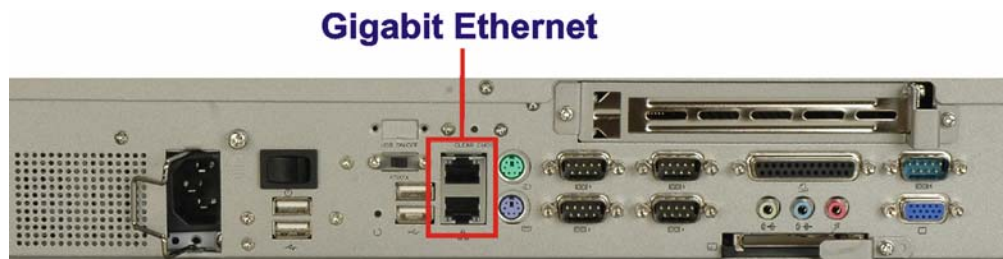

Figure 2-12: Ethernet

Some of the RTL8111CP controller features are listed below:

- Integrated 10/100/1000BASE-T transceiver
- Auto-Negotiation with Next Page capability
- PCIe v1.1
- Wake-On-LAN and remote wake-up support
- Supports pair swap/polarity/skew correction
- Crossover Detection & Auto-Correction

2.12 Front Panel

The front panel of the PPC-5xxx-9455 consists of an LCD monitor and a touch screen panel.

2.12.1 Flat Screen

The PPC-5xxx-9455 comes with a TFT LCD monitor. The tough construction of the TFT monitor allows the PPC-5xxx-9455 to withstand the conditions it is likely to be exposed to during regular use. Some of the specifications of the TFT monitors are shown below:

PPC-5xxx-9455 Panel PC

- Pixel pitch of 0.297 mm or less
- 700:1 contrast ratio or better
- 300 cd/m² or greater
- 8 msec optical response time or less
- 0°C to 50°C operating temperature

2.12.2 Touch Screen

The touch screen panel on the PPC-5xxx-9455 allows complete user interaction without the need for a keyboard or mouse. Some of the features of the touch panel are listed below.

- 5-wire analog resistive type
- 78% transmission
- Control chipset built onto the motherboard
- -10°C to 50°C operating temperature
- 7 V maximum voltage

2.13 OEM Options

Some of the peripheral device connectors are not connected to any devices. These connectors are reserved for OEM customizations. For a customized option, please contact the vendor, reseller, or IEI sales representative.

Chapter

3

Unpacking

3.1 Anti-static Precautions



Failure to take ESD precautions during the installation of the PPC-5xxx-9455 may result in permanent damage to the PPC-5xxx-9455 and severe injury to the user.

Electrostatic discharge (ESD) can cause serious damage to electronic components, including the PPC-5xxx-9455. Dry climates are especially susceptible to ESD. It is critical that the following anti-static precautions are strictly adhered to whenever handling the PPC-5xxx-9455 or any other electrical component.

- **Wear an anti-static wristband** - Wearing a simple anti-static wristband can help to prevent ESD from damaging the PPC-5xxx-9455.
- **Self-grounding** - Touch a grounded conducting material before handling and periodically while handling the PPC-5xxx-9455.
- **Use an anti-static pad** - When configuring the PPC-5xxx-9455, place it on an anti-static pad to reduce the possibility of ESD damage.
- **Only handle the edges of the PPC-5xxx-9455** - When handling the PPC-5xxx-9455, hold it by its edges.

3.2 Unpacking Precautions

When the PPC-5xxx-9455 is unpacked, please do the following:

- Follow the anti-static precautions outlined in **Section 3.1**.
- Make sure the packing box is facing upwards so the PPC-5xxx-9455 does not fall out of the box.
- Make sure all the components shown in **Section 3.3** are present.

3.3 Package Contents

NOTE:

If any components listed in the checklist below are missing, do not proceed with the installation. Contact the IEI reseller or vendor the PPC-5xxx-9455 was purchased from or contact an IEI sales representative directly by sending an email to sales@iei.com.tw.

The PPC-5xxx-9455 is shipped with the following components:

Quantity	Item and Part Number	Image
1	PPC-5xxx-9455	
1	Hard drive bracket	
1	IDE cable (40-pin to 40-pin)	
1	IDE cable (44-pin to 44-pin)	
1	Jumper pack	
1	Wall mounting kit	
1	Power cord	

PPC-5xxx-9455 Panel PC





Quantity	Item and Part Number	Image
1	Screw set	
1	IDE adapter (for slim CD-ROM)	
1	User manual CD and driver CD	
1	Touch pen	

Table 3-1: Package List Contents

Chapter

4

Installation and Configuration

PPC-5xxx-9455 Panel PC

4.1 Installation Precautions

When installing the PPC-5xxx-9455, please follow the precautions listed below:

- **Turn power off:** When installing the PPC-5xxx-9455 make sure the power is off. Failing to turn off the power may cause severe injury to the body and/or damage to the system.
- **Certified Engineers:** Only certified engineers should install and modify on-board functions.
- **Mounting:** The PPC-5xxx-9455 is a heavy device. When mounting the system onto a rack, panel, wall or arm please make sure that at least two people are assisting with the procedure.
- **Anti-static Discharge:** If a user open the rear panel of the PPC-5xxx-9455, to configure the jumpers or plug in added peripheral devices, ground themselves first and wear an anti-static wristband.

4.2 Preinstalled Components

The following components are all preinstalled.

- Motherboard
- TFT LCD
- Touch screen
- Power switch
- Power supply
- Inverter board
- PCI riser card
- System cooling fans

Preinstalled OEM customizations may include the following.

- CPU
- HDD
- CD drive
- DIMM

Removal and reinstallation of some of the components are described in **Chapter 4**.

4.3 Installation and Configuration Steps

The following installation steps must be followed.

Step 1: Unpack the PPC-5xxx-9455.

Step 2: Set the jumper settings.

Step 3: Install HDD, CompactFlash® and CD drive.

Step 4: Mount the PPC-5xxx-9455 flat panel PC.

Step 5: Connect peripheral devices to the bottom panel of the PPC-5xxx-9455.

Step 6: Configure the system.

PPC-5xxx-9455 Panel PC

4.4 Remove the Back Cover

Remove all the retention screws on the back cover. Lift the cover up to remove (Figure 4-1).

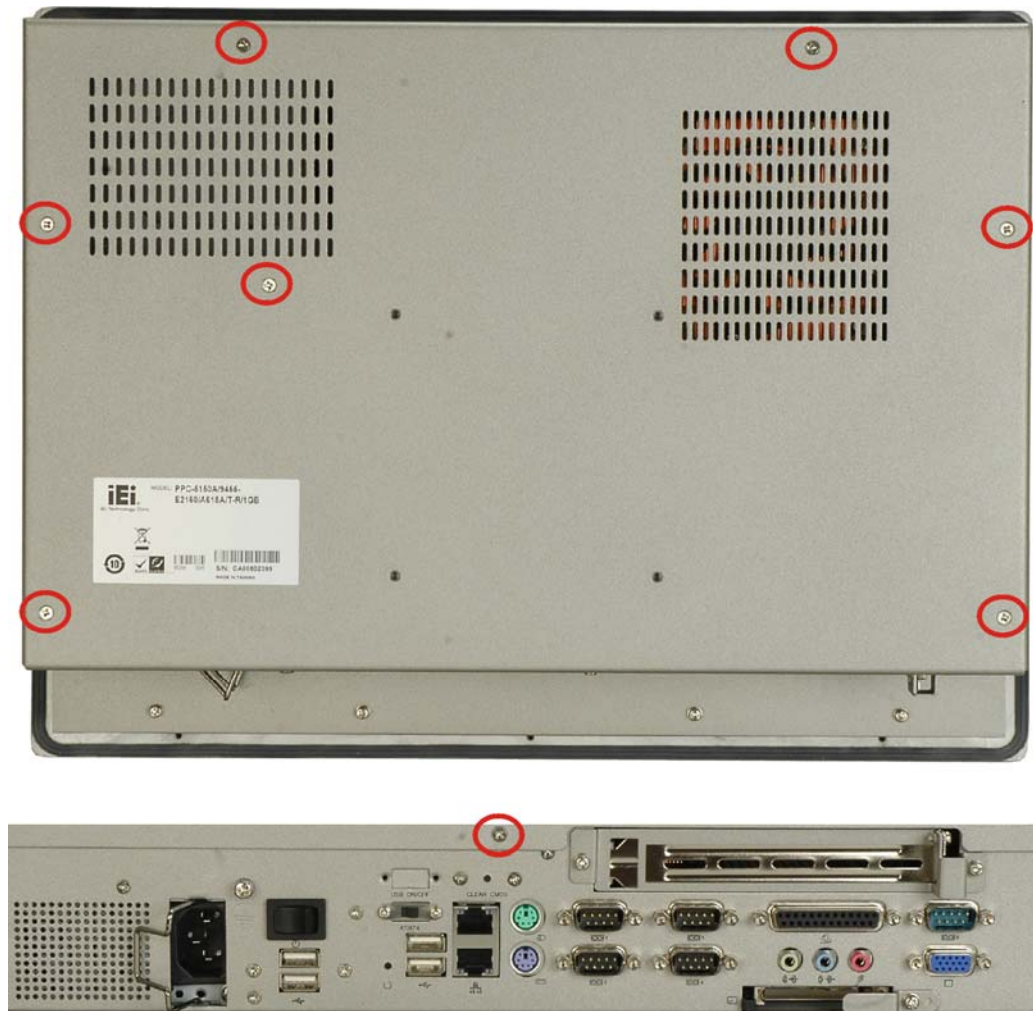

Figure 4-1: Back Cover Retention Screws

4.5 Jumper Settings

NOTE:

These jumper settings and the jumper locations are described in detail in the user manual that came with the POS-9455 motherboard. Please refer to the manual for more detailed descriptions of the jumper settings.

NOTE:

A jumper is a metal bridge that is used to close an electrical circuit. It consists of two metal pins and a small metal clip (often protected by a plastic cover that slides over the pins to connect them. To CLOSE/SHORT a jumper means connecting the pins of the jumper with the plastic clip and to OPEN a jumper means removing the plastic clip from a jumper.

The POS-9455 comes with some jumpers as listed in Table 4-1.

Jumper	Type	Label
AT/ATX power selection	2-pin header	AT_PWR_SW1
Clear CMOS	3-pin header	JP2
Monitor Setup	8-pin header	JP1
CompactFlash® card setup	2-pin header	JP7
COM port pin-9 setting	6-pin header	JP3, JP4, JP5, JP6, JP8
COM5 RS-232/422/485 RX select	6-pin header	J2
COM5 RS-422/485 TX select	6-pin header	J3

PPC-5xxx-9455 Panel PC

Jumper	Type	Label
COM5 D-SUB setup	12-pin header	J4
COM5 termination resistor	2-pin header	J5, J6
LCD voltage selection	6-pin header	JP9
Touch screen selection	4-pin header	J7

Table 4-1: Onboard Jumpers

4.5.1 AT/ATX Power Selection (AT_PWR_SW1)

The AT/ATX power selection switch selects AT or ATX power for the PPC-5xxx-9455. ATX power has more power saving capabilities than AT power.

The AT/ATX selection jumper is connected to the AT/ATX switch on the I/O panel of the PPC-5xxx-9455.

AT_PWR_SW1	DESCRIPTION
Closed	AT power
Open	ATX power

Table 4-2: AT/ATX Power Selection

4.5.2 Clear CMOS Setup (JP2)

If the motherboard fails to boot due to improper BIOS settings, use this jumper to clear the CMOS data and reset the system BIOS information. To do this, use the jumper cap to close pins 2 and 3 for a few seconds then reinstall the jumper clip back to pins 1 and 2.

If the “CMOS Settings Wrong” message displays during the boot up process, try to correct the fault by pressing the F1 to enter the CMOS Setup menu. Then do one of the following:

- Enter the correct CMOS setting
- Load Optimal Defaults

After one of the above has been done, save the changes and exit the CMOS Setup menu.

JP2	DESCRIPTION
1-2	Normal (Default)
2-3	Clear CMOS

Table 4-3: Clear CMOS Jumper Settings

4.5.3 Monitor Setup (JP1)

WARNING:

Do not change these settings. They are set for the installed LCD panel. Using different settings on the preinstalled monitor can destroy it.

The monitor setup jumper sets the default settings for all monitors connected to the PPC-5xxx-9455.

Pins 1-4 adjust the resolution of the screen.

JP1 (pins 1-4)	LCD Resolution
OPEN	1024 x 768 (18-bit)
1-2	1024 x 768 (24-bit)
3-4	1280 x 1024 (36-bit)
1-2, 3-4	1280 x 1024 (48-bit)

Table 4-4: LCD Resolution Settings

Pins 5-8 adjust the monitor setup on the system.

JP1 (pins 5-8)	Monitor Setup
OPEN	LVDS + CRT
5-6	LVDS
7-8	CRT
5-6, 7-8	Auto

Table 4-5: Monitor Settings

4.5.4 CF Card Setup (JP7)

The CF Card Setup jumper configures a CF card as either the IDE slave or IDE master.

JP7	DESCRIPTION
Open	Slave
Close	Master

Table 4-6: CF Card Setup Jumper Settings

4.5.5 COM Port RI and Voltage Selection (JP3, JP4, JP5, JP6, JP8)

Use the COM port settings jumpers to select the voltage of serial port pin 9.

JP3	COM1 Pin-9 Setting
1-2	12 V
3-4	RI
5-6	5 V

Table 4-7: COM1 RI and Voltage Selection Jumper

JP4	COM2 Pin-9 Setting
1-2	12 V
3-4	RI
5-6	5 V

Table 4-8: COM2 RI and Voltage Selection Jumper

JP5	COM3 Pin-9 Setting
1-2	12 V
3-4	RI
5-6	5 V

Table 4-9: COM3 RI and Voltage Selection Jumper

JP6	COM4 Pin-9 Setting
1-2	12 V
3-4	RI
5-6	5 V

Table 4-10: COM4 RI and Voltage Selection Jumper

JP8	COM5 Pin-9 Setting
1-2	12 V
3-4	RI
5-6	5 V

Table 4-11: COM5 RI and Voltage Selection Jumper

4.5.6 COM5 RS-232/422/485 Settings

To enable RS-232, RS-422 or RS-485 on COM5, all the following jumpers should be setup.

4.5.6.1 COM5 RS-232/422/485 RX Select (J2)

Jumper J2 sets the COM5 serial port as RS-232, RS-422 or RS-485.

J2	DESCRIPTION
1-2	RS232 (default)
3-4	RS422
5-6	RS485

Table 4-12: COM5 RS-232/422/485 RX Select

4.5.6.2 COM5 RS-422/485 TX Select (J3)

Jumper J3 sets the COM5 serial port as RS-422 or RS-485.

J3	DESCRIPTION
1-3, 2-4	RS422
3-5, 4-6	RS485

Table 4-13: COM5 RS-422/485 TX Select

4.5.6.3 COM5 D-Sub Pinout Selection (J4)

Jumper J4 sets the external COM5 serial port as RS-232 or RS-422/485.

J4	DESCRIPTION
1-2, 4-5, 7-8, 10-11	RS-232
2-3, 5-6, 8-9, 11-12	RS-422/485

Table 4-14: COM5 RS-422/485 TX Select

4.5.6.4 COM5 Termination Resistors (J5, J6)

The termination resistors J5 and J6 can remedy communication errors for RS-422/485 setups with cables over 1.5 km in length

J5	J6	DESCRIPTION
Open	Open	No terminator resistor set
Closed	Closed	Termination resistor set

Table 4-15: COM5 RS-422/485 TX Select

4.5.6.5 COM5 RS-422 and RS-485 Pinouts

The pinouts for RS-422 and RS-485 operation of serial port COM 5 are detailed below.

COM 5	RS-422 Description
Pin 1	TX-
Pin 2	TX+
Pin 6	RX-
Pin 7	RX+

Table 4-16: RS-422 Pinouts

COM 5	RS-485 Description
Pin 1	Data-
Pin 2	Data+

Table 4-17: RS-485 Pinouts

4.5.7 LCD Voltage Settings (JP9)



WARNING:

Do not change these settings. They are set for the installed LCD panel. Using different settings on the preinstalled monitor can destroy it.

The LCD setup sets the voltage and default monitor settings on the PPC-5xxx-9455.

JP9	LCD Voltage
1-2	3.3 V
3-4	5 V
5-6	12 V

Table 4-18: LCD Voltage Settings

4.5.8 Touch Screen Selection (JP7)

The touch screen selection jumper selects the type of touch screen panel connected to the system.

JP7	DESCRIPTION
1-2	5-wire touch panel
2-3 closed	4-wire or 8-wire touch panel

Table 4-19: Touch Screen Selection

4.6 Drive Installation

The drive installation process is shown in the sections below. The installation process of the following drives are shown.

- 4.6.1 Hard Drive Installation..... 49
- 4.6.2 CompactFlash® Installation 51
- 4.6.3 CD Drive Installation 52

PPC-5xxx-9455 Panel PC

4.6.1 Hard Drive Installation

To install a HDD, please follow the steps below:

Step 1: Remove the back cover (**Section 4.4**).

Step 2: The HDD bracket is attached to the elevated platform by four retention screws.

Remove the four retention screws from the elevated platform (**Figure 4-2**).

Hard Drive Bracket Screws

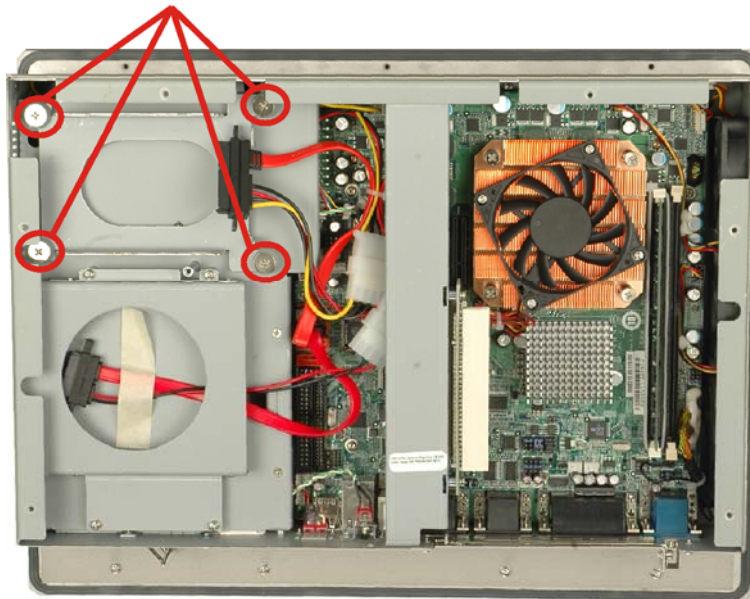

Figure 4-2: HDD Retention Screws

Step 3: Attach the SATA connector cable to the bracket.



Figure 4-3: HDD SATA Connector

Step 4: Attach the hard drive in the bracket. To do this, slide the hard drive onto the bracket until it connects with the SATA connector at the back. Fasten the four retention screws on the side.

Hard Drive Screws

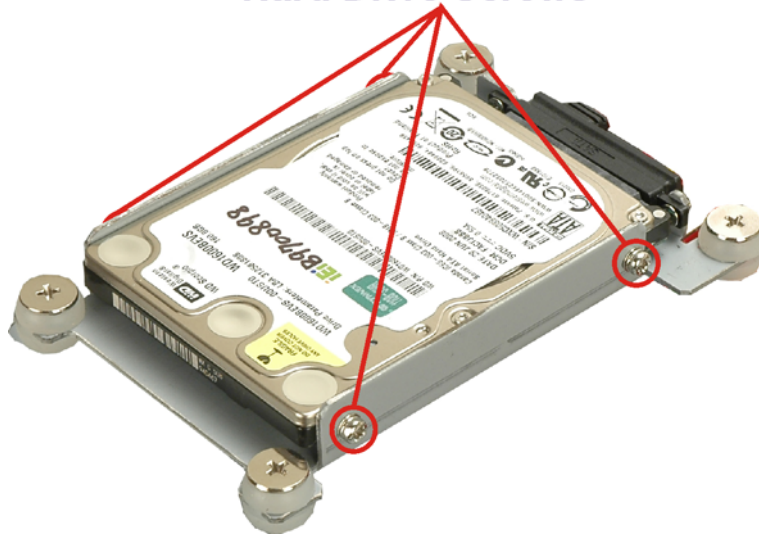

Figure 4-4: HDD Retention Screws

Step 5: Install the hard drive bracket (with hard drive and SATA cable attached) into the PPC-5xxx-9455 and fasten the four hard drive bracket screws.

Hard Drive Bracket Screws

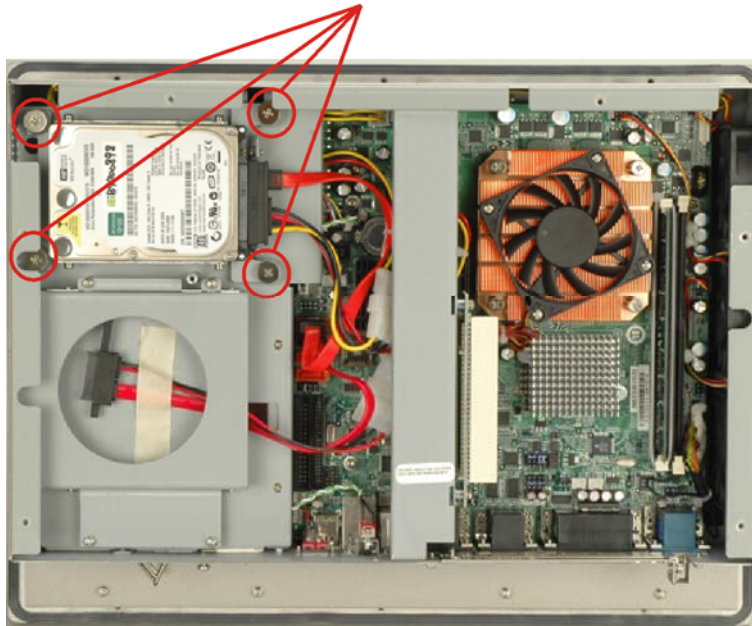

Figure 4-5: HDD Retention Screws

4.6.2 CompactFlash® Installation

To install the CompactFlash® card, please follow the steps below:

- Step 1:** Undo the CompactFlash® slot cover screw and remove the CompactFlash® cover plate.

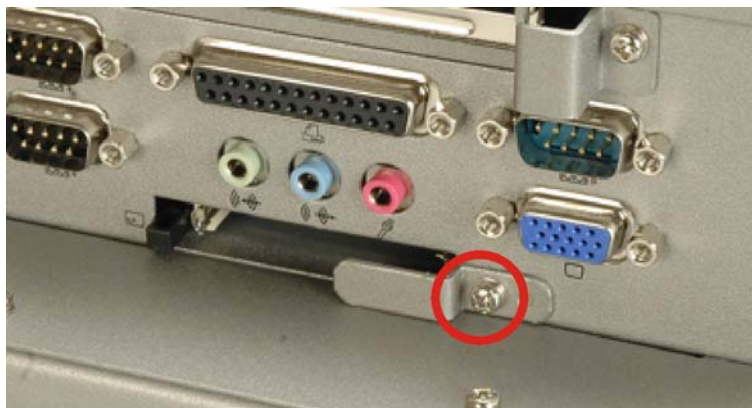

Figure 4-6: CompactFlash® Cover Plate

Step 2: Insert the CompactFlash® card into the slot.



Figure 4-7: CompactFlash® Slot

Step 3: Fasten the CompactFlash® cover plate.



Figure 4-8: CompactFlash® Cover Plate

4.6.3 CD Drive Installation

To install a CD drive, please follow the steps below.

Step 1: Remove the back cover (**Section 4.4**).

Step 2: Attach the CD drive adapter to the CD-ROM if it is an IDE drive (if it is a SATA drive, proceed to Step 5:). Attach a CD drive adapter to a CD drive by aligning the two retention screw holes in the CD drive adapter with the retention screw holes on the rear side of the CD drive.

Step 3: Place two spacers between the CD drive and CD drive adapter.

Step 4: Insert two retention screws and secure the adapter to the CD drive (**Figure 4-9**).

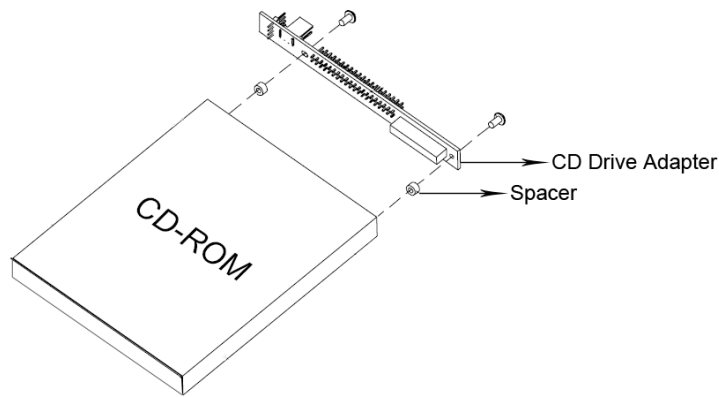

Figure 4-9: CD Drive Adapter Installation

Step 5: Undo the optical drive bracket screws and remove the optical drive bracket.

Optical Drive Bracket Screws

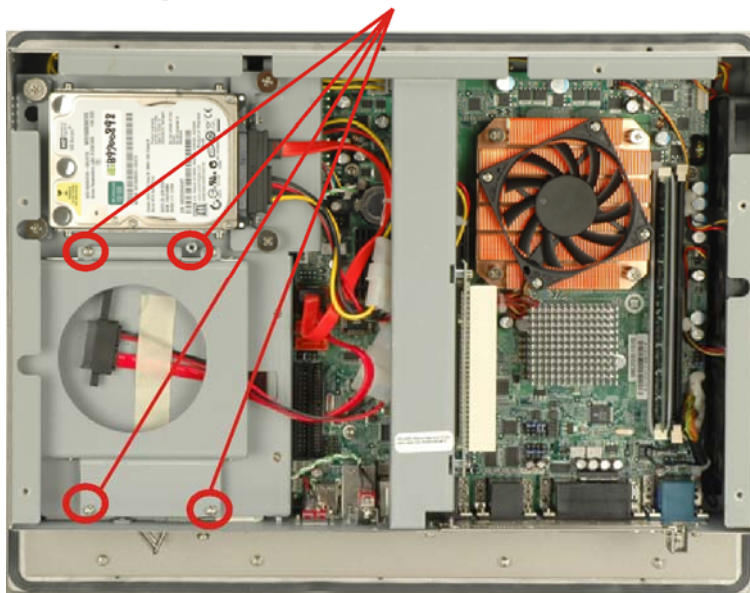

Figure 4-10: CD Drive Retention Screws

Step 6: Remove the four screws from the optical drive bracket assembly. Remove the blank drive plate.

Optical Drive Blank Plate Screws

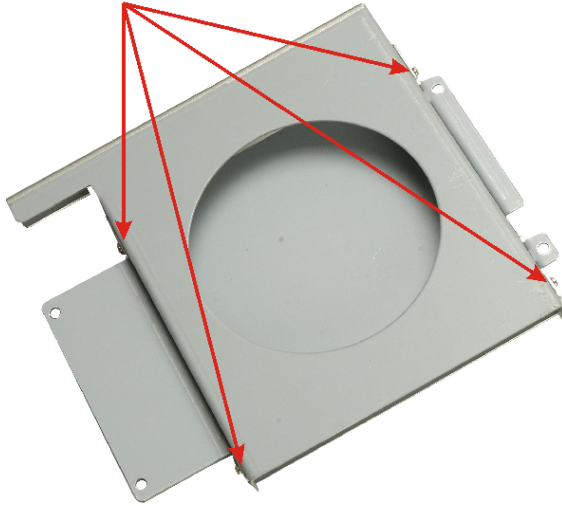

Figure 4-11: Optical Drive Blank Plate Assembly

PPC-5xxx-9455 Panel PC

Step 7: Install the optical drive in the same position as the previously removed blank optical drive plate. Fasten the same four screws to attach the optical drive to the bracket.

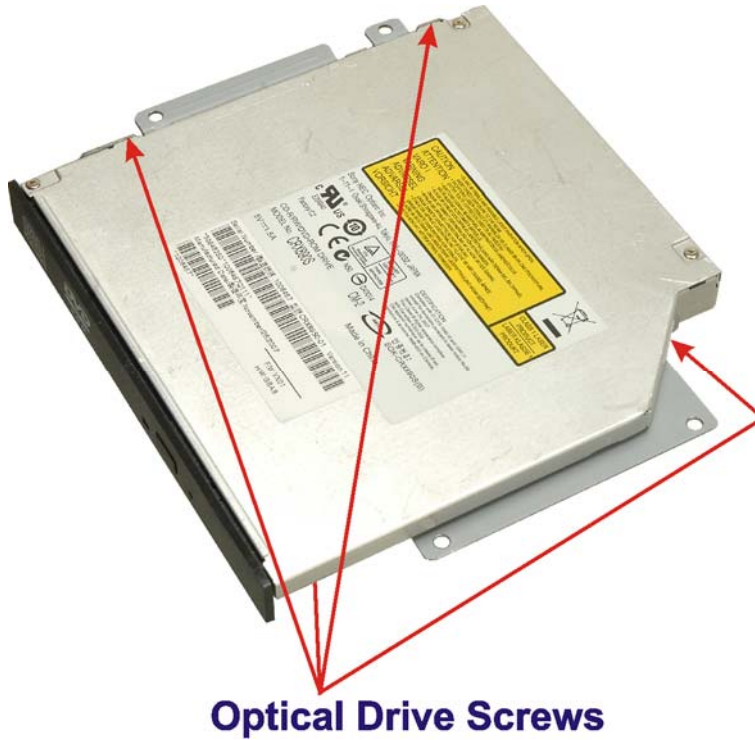

Figure 4-12: Optical Drive Screws

Step 8: Attach the SATA cable to the back of the optical drive and fasten the SATA cable screws.

SATA Cable and Screws



Figure 4-13: Optical Drive SATA Cable

Step 9: Reinstall the optical drive bracket into the PPC-5xxx-9455 and fasten the optical bracket screws.

Optical Drive Bracket Screws

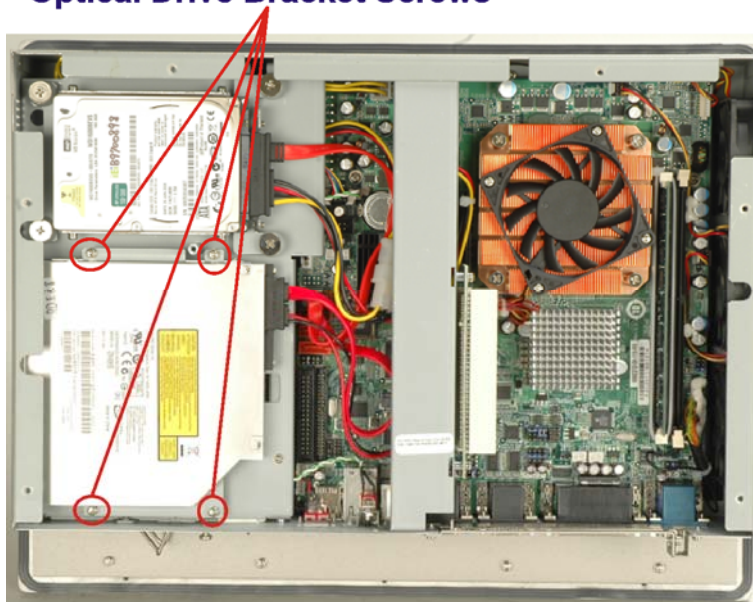

Figure 4-14: Optical Drive Bracket Screws

4.7 Mounting the System



WARNING!

When mounting the PPC-5xxx-9455 flat panel PC onto an arm, wall or into a panel, it is advisable to have more than one person help with the installation to prevent accidental damage to the panel and avoid personal injury.

The methods of mounting the PPC-5xxx-9455 are:

- Wall mounting
- Panel mounting
- Arm mounting
- Rack mounting

The mounting methods are fully described below.

4.7.1 Wall Mounting

To mount the PPC-5xxx-9455 flat panel PC onto a wall, please follow the steps below.

Step 1: Select the location on the wall for the wall-mounting bracket.

Step 2: Carefully mark the locations of the four bracket screw holes on the wall.

Step 3: Drill four pilot holes at the marked locations on the wall for the bracket retention screws.

Step 4: Align the wall-mounting bracket screw holes with the pilot holes.

Step 5: Secure the mounting-bracket to the wall by inserting the retention screws into the four pilot holes and tightening them.

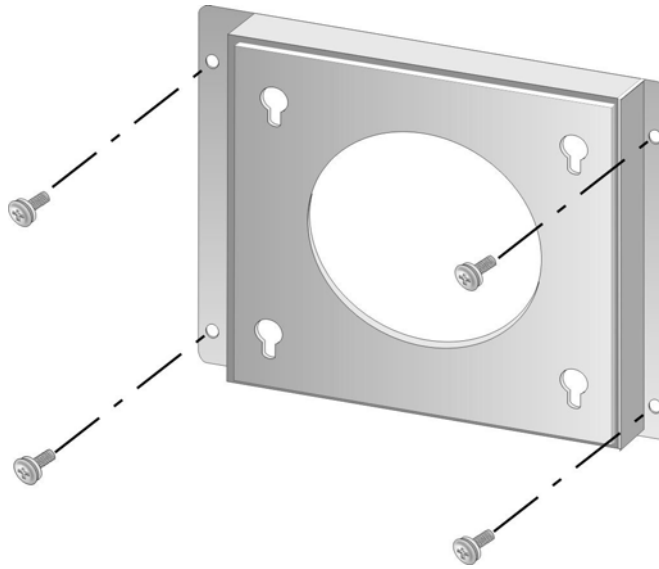

Figure 4-15: Wall-mounting Bracket

- Step 6:** Insert the four monitor mounting screws provided in the wall mounting kit into the four screw holes on the rear panel of the monitor and tighten until the screw shank is secured against the rear panel.
- Step 7:** Align the mounting screws on the monitor rear panel with the mounting holes on the bracket.
- Step 8:** Carefully insert the screws through the holes and gently pull the monitor downwards until the monitor rests securely in the slotted holes. Ensure that all four of the mounting screws fit snugly into their respective slotted holes.



NOTE:

In the diagram below the bracket is already installed on the wall.

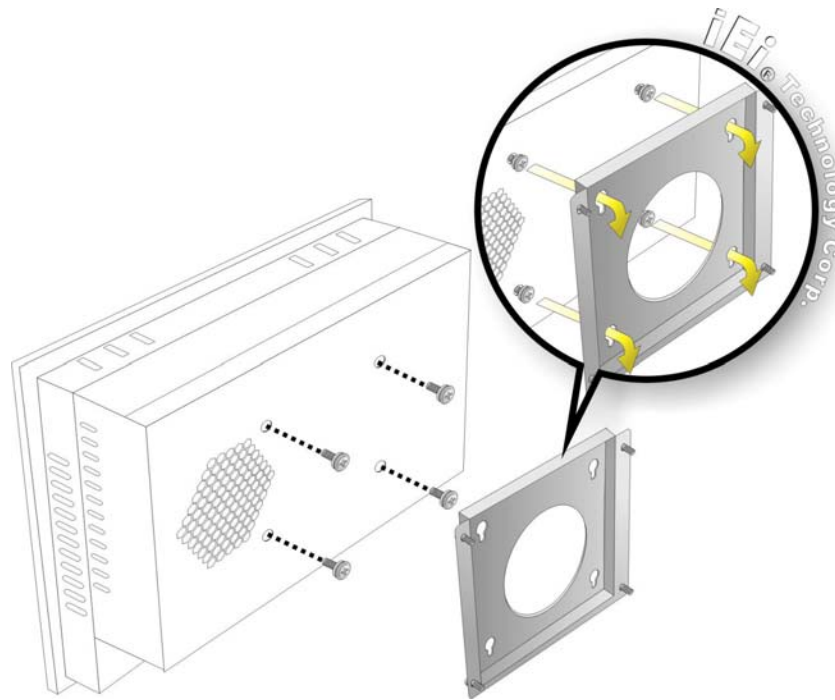

Figure 4-16: Mount the Chassis

Step 9: Secure the panel PC with the wall-mounting kit. To do this, stick the protective cushion to the wall-mounting kit first. Then, put the wall-mounting kit on the top panel of the panel PC. Carefully mark the location of the wall-mounting kit screw holes on the wall. Drill a pilot hole at the marked location on the wall. Secure the wall-mounting kit to the wall by inserting a retention screw into the pilot hole on the wall (**Figure 4-17**). This step is to avoid the panel PC being pushed apart from the wall-mounting bracket accidentally.

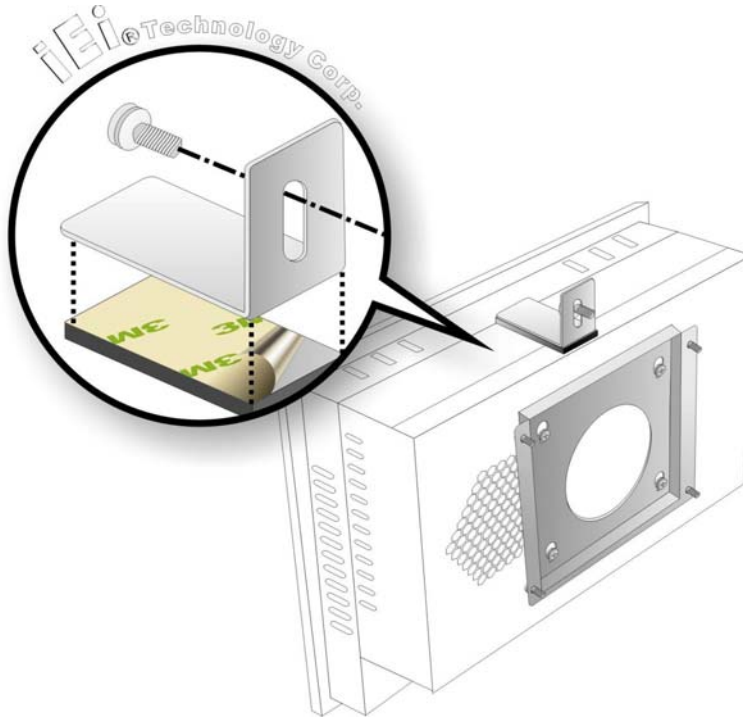

Figure 4-17: Secure the Chassis

4.7.2 Panel/ Mounting

To mount the PPC-5xxx-9455 flat panel PC into a panel, please follow the steps below.



NOTE:

The maximum panel thickness should be no more than 6 mm.

Step 1: Select the position on the panel to mount the PPC-5xxx-9455.

Step 2: Cut out a section of the panel that corresponds to the rear panel dimensions of the PPC-5xxx-9455. The recommended cutout sizes are shown below (Figure 4-18, Figure 4-19 and Figure 4-20).

PPC-5xxx-9455 Panel PC

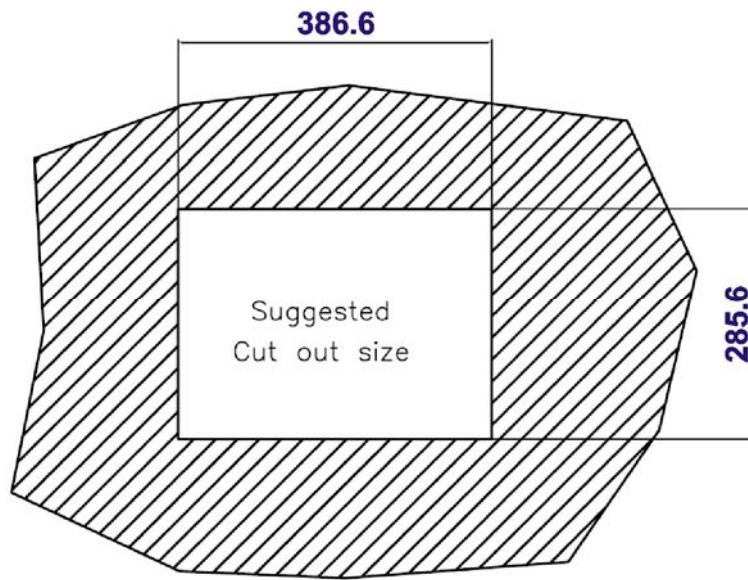

Figure 4-18: 15" Panel Cutout Dimensions

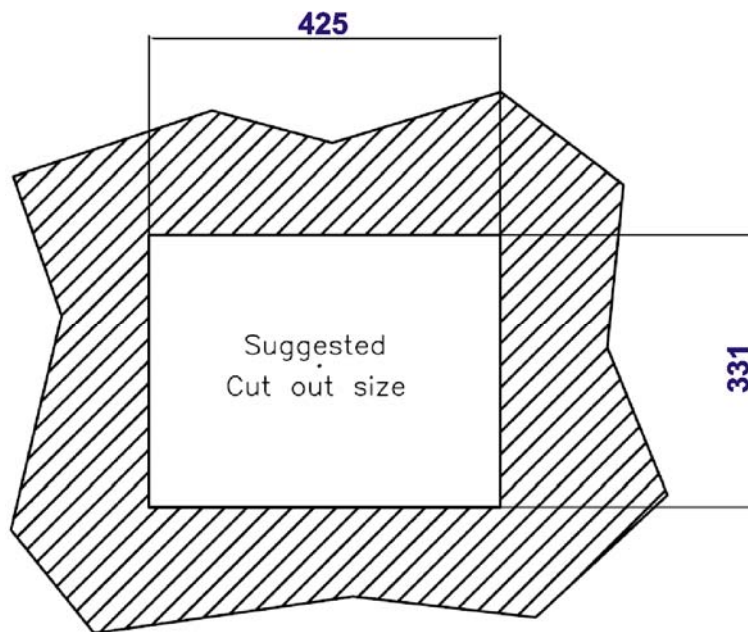

Figure 4-19: 17" Panel Cutout Dimensions

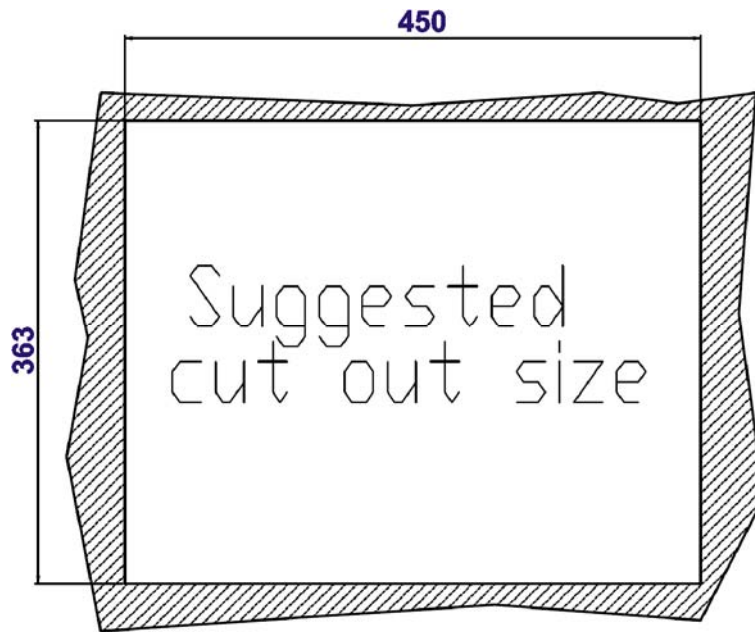

Figure 4-20: 19" Panel Cutout Dimensions

- Step 3:** Slide the PPC-5xxx-9455 through the hole until the metal frame is flush against the panel.
- Step 4:** Insert the panel mounting clamps into the pre-formed holes along the edges of the PPC-5xxx-9455, behind the metal frame (**Figure 4-21**). Refer to the mounting kit packing list for the required number of mounting clamps.

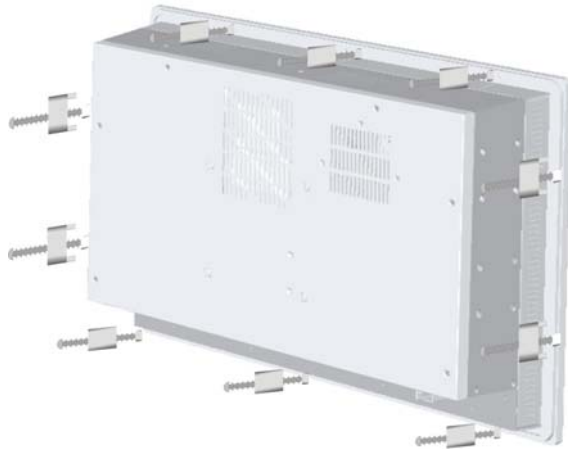

Figure 4-21: Panel Mounting Clamp Positions

Step 5: Tighten the screws that pass through the panel mounting clamps until the plastic caps at the front of all the screws are firmly secured to the panel (**Figure 4-22**).

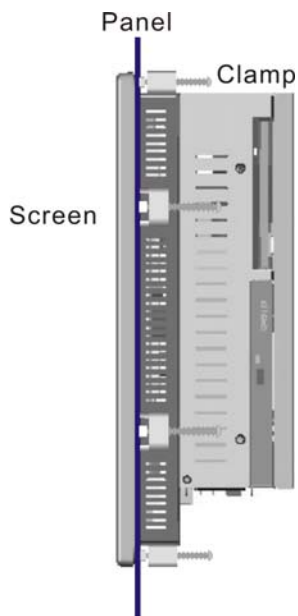

Figure 4-22: Tighten the Panel Mounting Clamp Screws

4.7.3 Rack and Cabinet Installation

To mount the PPC-5xxx-9455 into a rack/cabinet, please follow the steps below.



NOTE:

When purchasing the cabinet/rack installation bracket, make sure it is compatible with both the PPC-5xxx-9455 flat panel PC and the rack/cabinet into which the PPC-5xxx-9455 is installed.

Step 1: Slide the rear of the PPC-5xxx-9455 panel PC through the rack/cabinet bracket until the aluminum frame is flush against the front of the bracket (**Figure 4-23**).

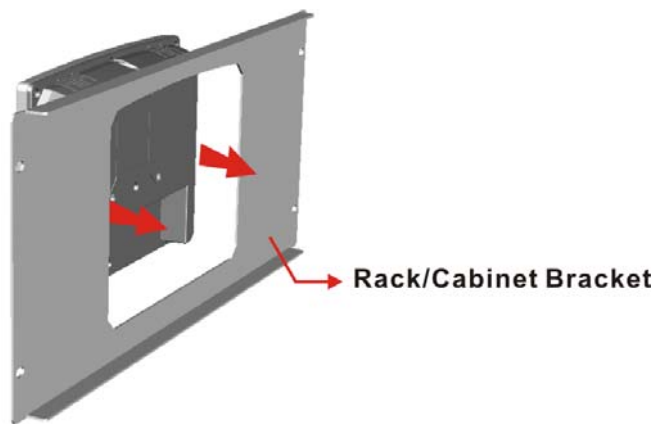

Figure 4-23: The Rack/Cabinet Bracket

Step 2: Insert the rack mounting clamps into the pre-formed holes along the edges of the panel PC, behind the ABS/PC plastic frame.

Step 3: Tighten the screws that pass through the rack mounting clamps until the plastic caps at the front of all the screws are firmly secured to the bracket (**Figure 4-24**).

PPC-5xxx-9455 Panel PC

Rack/Cabinet Bracket

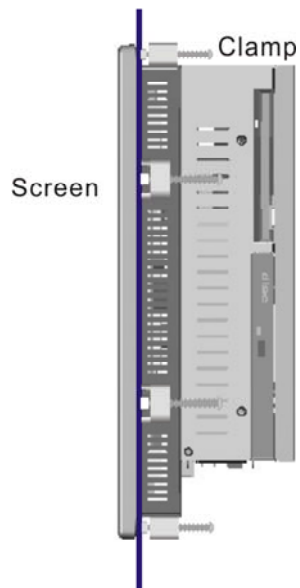

Figure 4-24: Secure the Rack/Cabinet Bracket

Step 4: Slide the panel PC with the attached rack/cabinet bracket into a rack or cabinet (Figure 4-25).

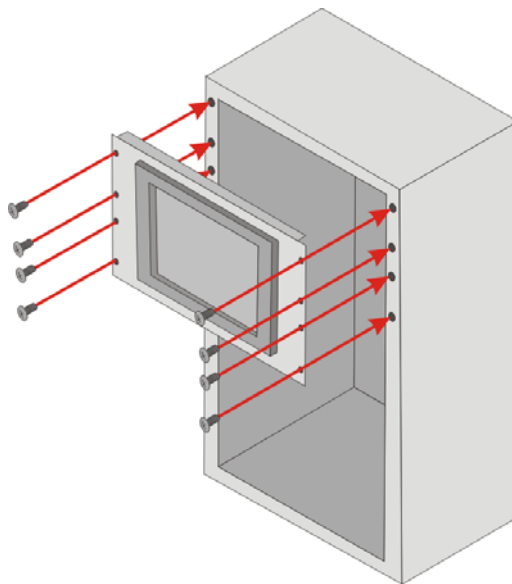

Figure 4-25: Install into a Rack/Cabinet

Step 5: Once the panel PC with the attached rack/cabinet bracket has been properly inserted into the rack or cabinet, secure the front of the rack/cabinet bracket to the front of the rack or cabinet (**Figure 4-25**).

4.7.4 Arm Mounting

The PPC-5xxx-9455 is VESA (Video Electronics Standards Association) compliant and can be mounted on an arm with a 100 mm interface pad. To mount the PPC-5xxx-9455 on an arm, please follow the steps below.

Step 1: The arm is a separately purchased item. Please correctly mount the arm onto the surface it uses as a base. To do this, refer to the installation documentation that came with the mounting arm.



NOTE:

When purchasing the arm please ensure that it is VESA compliant and that the arm has a 100 mm interface pad. If the mounting arm is not VESA compliant, it cannot be used to support the PPC-5xxx-9455 flat panel PC.

Step 2: Once the mounting arm has been firmly attached to its surface, lift the PPC-5xxx-9455 flat panel PC onto the interface pad of the mounting arm.

Step 3: Align the retention screw holes on the mounting arm interface with those in the PPC-5xxx-9455 flat panel PC. The PPC-5xxx-9455 flat panel PC arm mount retention screw holes are shown below.

PPC-5xxx-9455 Panel PC

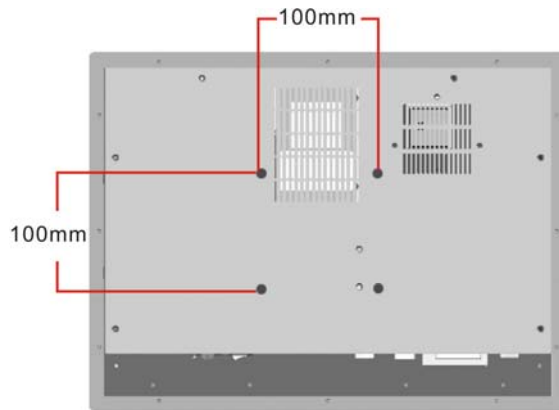

Figure 4-26: Arm Mount Retention Screw Holes

Step 4: Secure the PPC-5xxx-9455 to the interface pad by inserting four retention screws through the mounting arm interface pad and into the PPC-5xxx-9455 flat panel PC.

4.8 External Peripheral Interface Connectors

4.8.1 LCD Panel Connection

A conventional CRT VGA 15-pin female D-SUB connector is located on the bottom panel to connect the PPC-5xxx-9455 flat panel PC to a second monitor.



NOTE:

To use the dual screen option, please configure this option in the Intel® Extreme Graphics configuration settings. To do this, open the Control Panel, locate the Intel® Extreme Graphics icon and click on it. Once opened, an option for Multiple Display is available. Select this option and select notebook as the primary device.

4.8.2 Ethernet Connection

The two external peripheral interface RJ-45 connectors can be connected to an external LAN to provide Internet connectivity to the flat panel PC.

4.8.3 USB Connection

The external peripheral interface USB connectors provide easy and quick access to external USB devices. The external peripheral interface USB connectors are a standard connector and can easily be connected to other USB devices.

4.8.4 Keyboard and Mouse Connection

Two PS/2 connectors on the external peripheral interface panel facilitate the connection of a mouse and a keyboard. To connect either device, plug the PS/2 connector at the end of the keyboard or mouse cable into the corresponding PS/2 connector on the external peripheral interface panel.

4.8.5 Parallel Port Connection

The parallel port is typically connected to a printer, but can also be connected to other parallel devices.

4.8.6 Serial Port Connection

The external peripheral interface panel serial connectors provide easy and quick access to external serial devices.

4.8.7 Audio Port Connection

The external peripheral interface panel audio ports provide line in, line out and speaker connectivity.

Chapter

5

BIOS Setup

5.1 Introduction

A licensed copy of AMI BIOS is preprogrammed into the ROM BIOS. The BIOS setup program allows users to modify the basic system configuration. This chapter describes how to access the BIOS setup program and the configuration options that may be changed.

5.1.1 Starting Setup

The AMI BIOS is activated when the computer is turned on. The setup program can be activated in one of two ways.

1. Press the **DELETE** key as soon as the system is turned on or
2. Press the **DELETE** key when the “**Press Del to enter SETUP**” message appears on the screen.

If the message disappears before the **DELETE** key is pressed, restart the computer and try again.

5.1.2 Using Setup

Use the arrow keys to highlight items, press **ENTER** to select, use the PageUp and PageDown keys to change entries, press **F1** for help and press **ESC** to quit. Navigation keys are shown in.

Key	Function
Up arrow	Move to previous item
Down arrow	Move to next item
Left arrow	Move to the item on the left hand side
Right arrow	Move to the item on the right hand side
Esc key	Main Menu – Quit and not save changes into CMOS Status Page Setup Menu and Option Page Setup Menu -- Exit current page and return to Main Menu
Page Up key	Increase the numeric value or make changes
Page Dn key	Decrease the numeric value or make changes

Key	Function
F1 key	General help, only for Status Page Setup Menu and Option Page Setup Menu
F2 /F3 key	Change color from total 16 colors. F2 to select color forward.
F10 key	Save all the CMOS changes, only for Main Menu

Table 5-1: BIOS Navigation Keys

5.1.3 Getting Help

When **F1** is pressed a small help window describing the appropriate keys to use and the possible selections for the highlighted item appears. To exit the Help Window press **Esc** or the **F1** key again.

5.1.4 Unable to Reboot After Configuration Changes

If the computer cannot boot after changes to the system configuration is made, CMOS defaults. Use the jumper described in **Section 4.5**.

5.1.5 BIOS Menu Bar

The **menu bar** on top of the BIOS screen has the following main items:

- Main Changes the basic system configuration.
- Advanced Changes the advanced system settings.
- PCIPnP Changes the advanced PCI/PnP Settings
- Boot Changes the system boot configuration.
- Security Sets User and Supervisor Passwords.
- Chipset Changes the chipset settings.
- Exit Selects exit options and loads default settings

The following sections completely describe the configuration options found in the menu items at the top of the BIOS screen and listed above.

5.2 Main

The **Main** BIOS menu (**BIOS Menu 1**) appears when the **BIOS Setup** program is entered. The **Main** menu gives an overview of the basic system information.

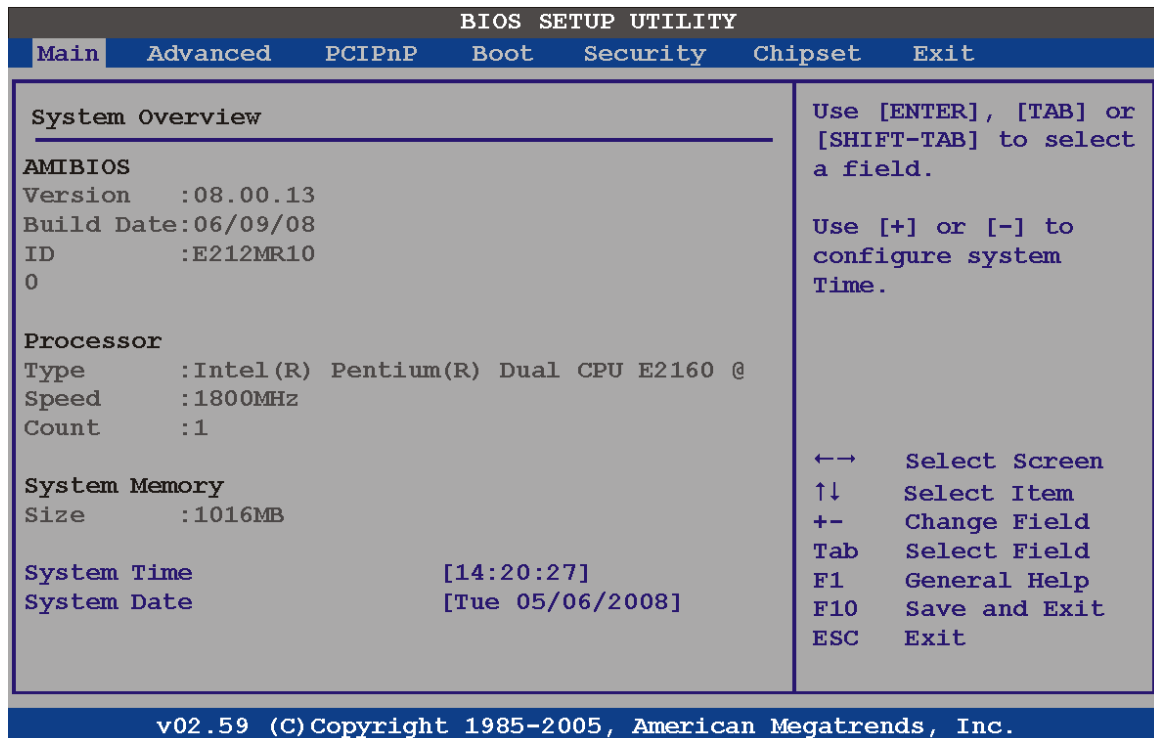

BIOS Menu 1: Main

→ System Overview

The **System Overview** lists a brief summary of different system components. The fields in **System Overview** cannot be changed. The items shown in the system overview include:

- AMI BIOS: Displays auto-detected BIOS information
 - **Version:** Current BIOS version
 - **Build Date:** Date the current BIOS version was made
 - **ID:** Installed BIOS ID
- Processor: Displays auto-detected CPU specifications
 - **Type:** Names the currently installed processor
 - **Speed:** Lists the processor speed
 - **Count:** The number of CPUs on the motherboard

PPC-5xxx-9455 Panel PC

- System Memory: Displays the auto-detected system memory.
 - **Size:** Lists memory size

The **System Overview** field also has two user configurable fields:

➔ **System Time [xx:xx:xx]**

Use the **System Time** option to set the system time. Manually enter the hours, minutes and seconds.

➔ **System Date [xx/xx/xx]**

Use the **System Date** option to set the system date. Manually enter the day, month and year.

5.3 Advanced

Use the **Advanced** menu (**BIOS Menu 2**) to configure the CPU and peripheral devices through the following sub-menus:



WARNING!

Setting the wrong values in the sections below may cause the system to malfunction. Make sure that the settings made are compatible with the hardware.

▪ 5.3.1 CPU Configuration	75
▪ 5.3.2 IDE Configuration.....	77
▪ 5.3.3 Floppy Configuration.....	84
▪ 5.3.4 Super IO Configuration	85
▪ 5.3.5 Hardware Health Configuration.....	90
▪ 5.3.6 Power Configuration	95
▪ 5.3.7 Remote Access Configuration.....	100
▪ 5.3.8 USB Configuration	103

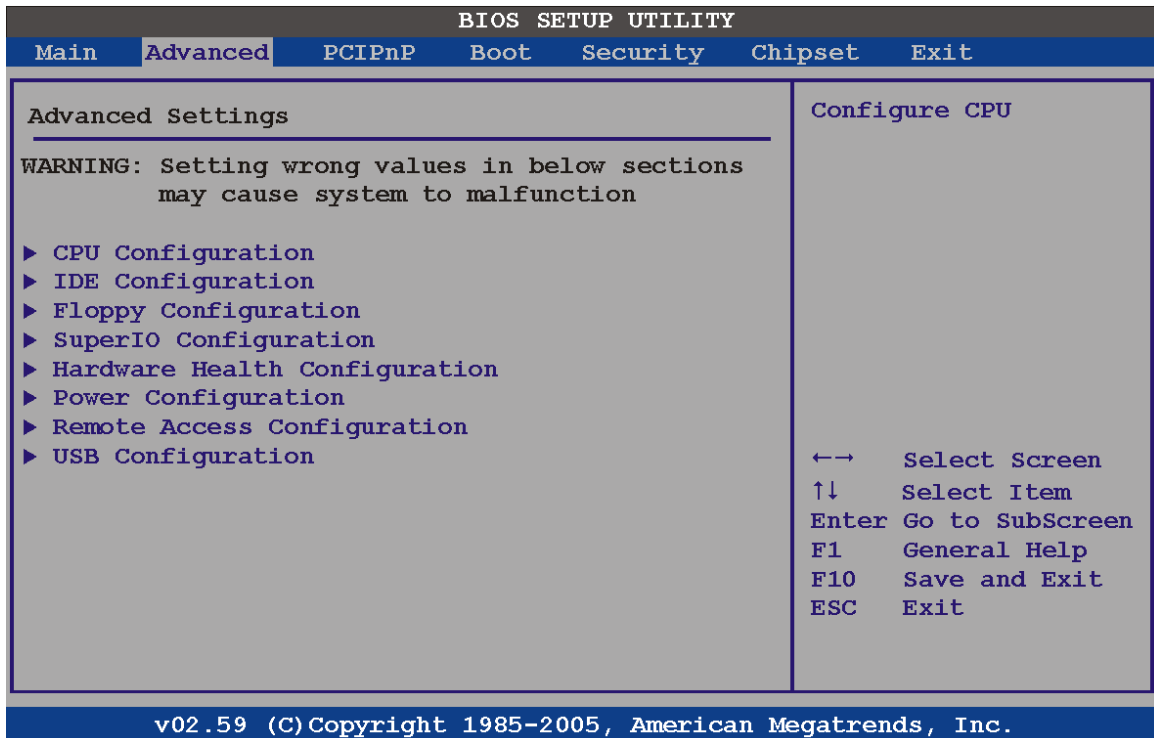

BIOS Menu 2: Advanced

PPC-5xxx-9455 Panel PC

5.3.1 CPU Configuration

Use the CPU Configuration menu (BIOS Menu 3) to view detailed CPU specifications and configure the CPU.

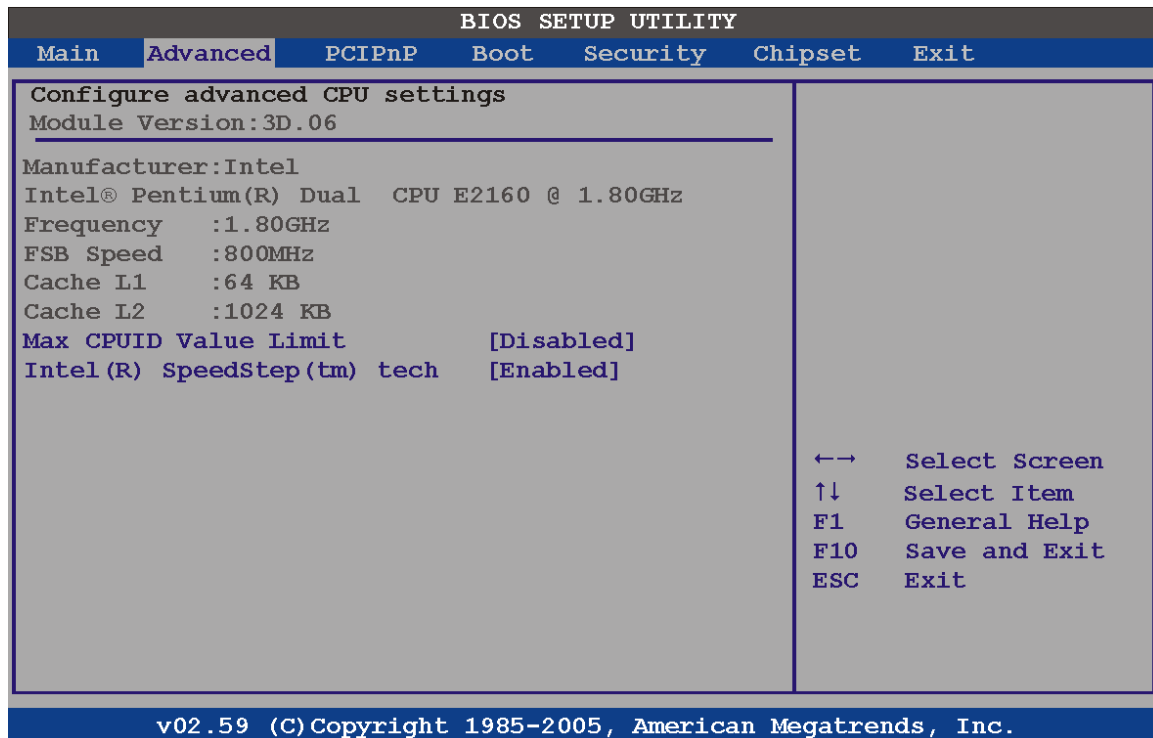

BIOS Menu 3: CPU Configuration

The CPU Configuration menu (BIOS Menu 3) lists the following CPU details:

- Manufacturer: Lists the name of the CPU manufacturer
- Brand String: Lists the brand name of the CPU being used
- Frequency: Lists the CPU processing speed
- FSB Speed: Lists the FSB speed
- Cache L1: Lists the CPU L1 cache size
- Cache L2: Lists the CPU L2 cache size

➔ Max CPUID Value Limit [Disabled]

The Max CPUID Value Limit option to allow an older operating system such as Windows 95 or Windows 98 to work with Pentium® 4 processors with Hyper-Threading Technology

(HTT). If the operating system recognizes the installed processor, then this option should be kept in the default **Disabled** setting.

- ➔ **Disabled** **DEFAULT** CPUID is reported in full.
- ➔ **Enabled** Limits the maximum CPUID to 30h.

➔ **Intel® SpeedStep® Technology [Enabled]**

The Intel® SpeedStep® Technology option allows the processor to use SpeedStep® if the processor supports it.

- ➔ **Disabled** SpeedStep® is always disabled
- ➔ **Enabled** **DEFAULT** SpeedStep® is enabled if supported by the processor

PPC-5xxx-9455 Panel PC

5.3.2 IDE Configuration

Use the **IDE Configuration** menu (**BIOS Menu 4**) to change and/or set the configuration of the IDE devices installed in the system.

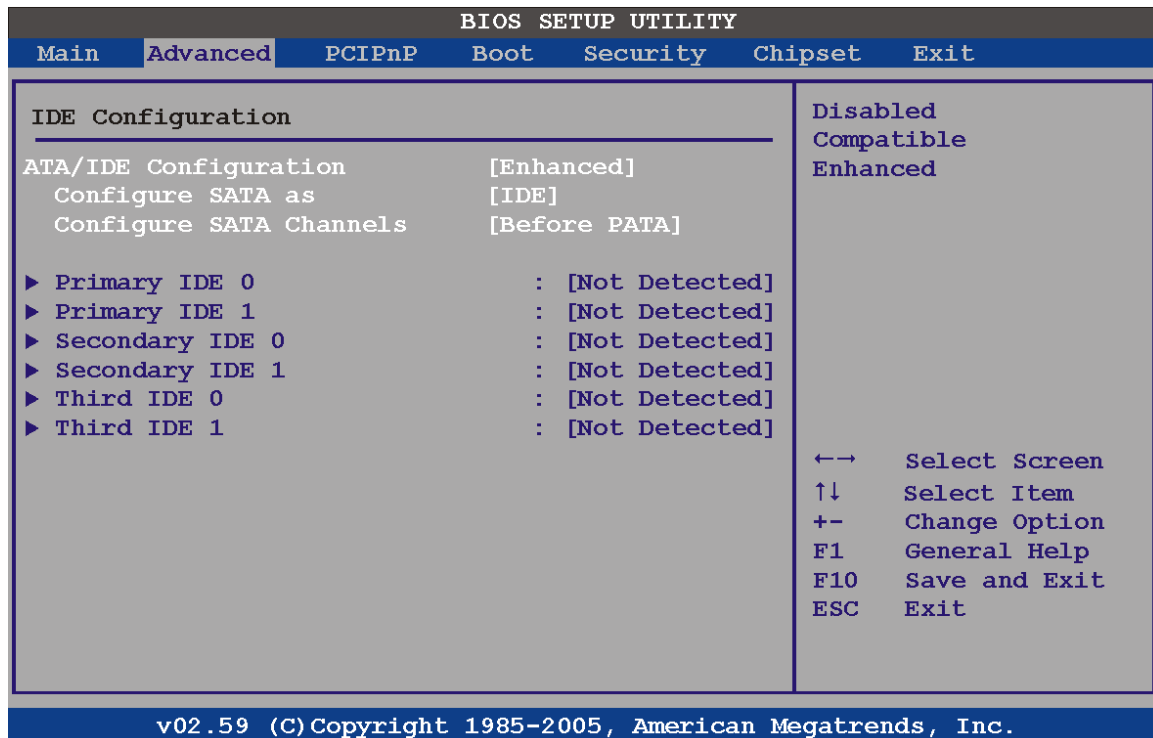

BIOS Menu 4: IDE Configuration

→ ATA/IDE Configurations [Enhanced]

Use the **ATA/IDE Configurations** option to configure the ATA/IDE controller.

- **Disabled** Disables the on-board ATA/IDE controller.
- **Compatible** Configures the on-board ATA/IDE controller to be in compatible mode. In this mode, a SATA channel will replace one of the IDE channels. This mode supports up to 4 storage devices.

- **Enhanced** **DEFAULT** Configures the on-board ATA/IDE controller to be in Enhanced mode. In this mode, IDE channels and SATA channels are separated. Some legacy OS do not support this mode.

→ **Configure SATA as [IDE]**

The “Configure SATA as” option sets the configuration of the SATA ports.

- **IDE** **DEFAULT** The SATA drives are configured as IDE devices and no enhanced functions are available

→ **Configure SATA Channels [IDE]**

The “Configure SATA Channels” option sets the order in which the IDE devices are configured.

- **Before PATA** **DEFAULT** The SATA drives are configured before the PATA drives
- **Behind PATA** The SATA drives are configured after the PATA drives

→ **Legacy IDE Channels [PATA Pri, SATA Sec]**

- **SATA Only** Only the SATA drives are enabled.
- **PATA Pri, SATA Sec** **DEFAULT** The IDE drives are enabled on the Primary IDE channel. The SATA drives are enabled on the Secondary IDE channel.
- **PATA Pri., PATA Sec** The IDE drives are enabled on the primary and secondary IDE channels. SATA drives are disabled.
- **PATA Only** Only the PATA drives are enabled.

→ **IDE Master and IDE Slave**

When entering setup, BIOS auto detects the presence of IDE devices. BIOS displays the status of the auto detected IDE devices. The following IDE devices are detected and are shown in the **IDE Configuration** menu:

PPC-5xxx-9455 Panel PC

- Primary IDE Master
- Primary IDE Slave

The **IDE Configuration** menu (**BIOS Menu 4**) allows changes to the configurations for the IDE devices installed in the system. If an IDE device is detected, and one of the above listed four BIOS configuration options are selected, the IDE configuration options shown in **Section 5.3.2.1** appear.

5.3.2.1 IDE Master, IDE Slave

Use the **IDE Master** and **IDE Slave** configuration menu to view both primary and secondary IDE device details and configure the IDE devices connected to the system.

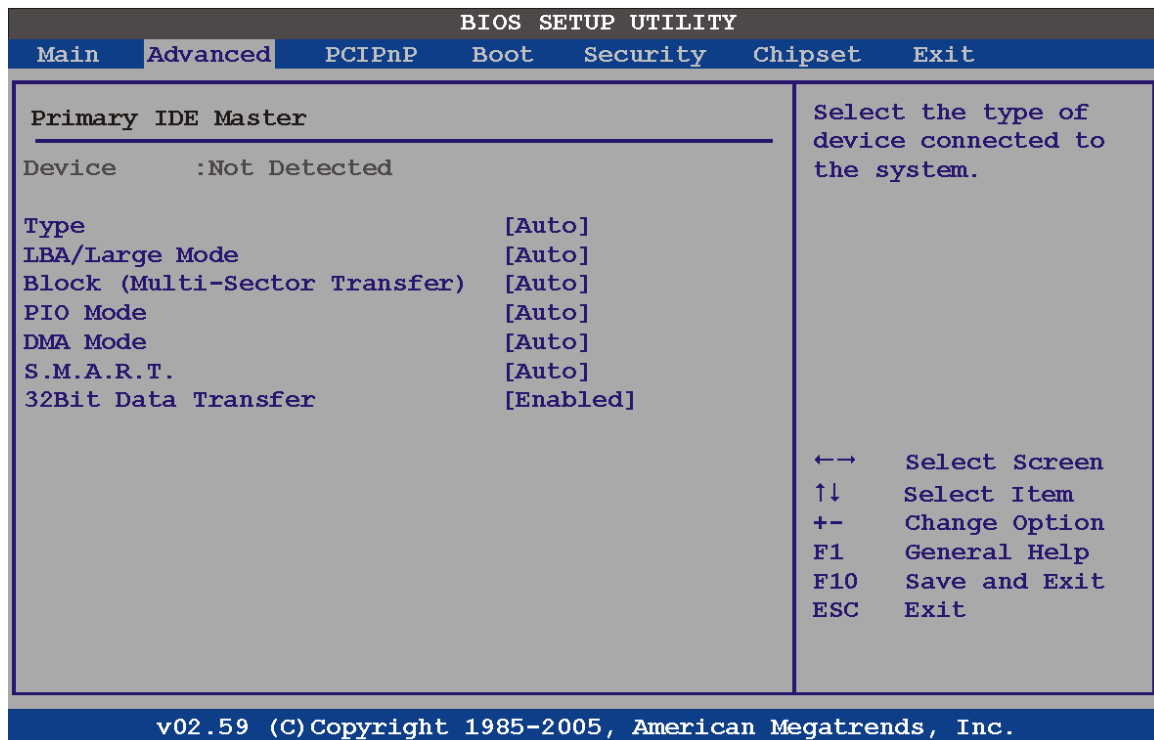

BIOS Menu 5: IDE Master and IDE Slave Configuration

➔ Auto-Detected Drive Parameters

The “grayed-out” items in the left frame are IDE disk drive parameters automatically detected from the firmware of the selected IDE disk drive. The drive parameters are listed as follows:

- **Device:** Lists the device type (e.g. hard disk, CD-ROM etc.)
- **Type:** Indicates the type of devices a user can manually select
- **Vendor:** Lists the device manufacturer
- **Size:** List the storage capacity of the device.
- **LBA Mode:** Indicates whether the LBA (Logical Block Addressing) is a method of addressing data on a disk drive is supported or not.
- **Block Mode:** Block mode boosts IDE drive performance by increasing the amount of data transferred. Only 512 bytes of data can be transferred per interrupt if block mode is not used. Block mode allows transfers of up to 64 KB per interrupt.
- **PIO Mode:** Indicates the PIO mode of the installed device.
- **DMA Mode:** Indicates the highest DMA Mode that is supported.
- **S.M.A.R.T.:** Indicates whether or not the Self-Monitoring Analysis and Reporting Technology protocol is supported.
- **32Bit Data Transfer:** Enables 32-bit data transfer.

➔ **Type [Auto]**

Use the **Type** BIOS option select the type of device the AMIBIOS attempts to boot from after the Power-On Self-Test (POST) is complete.

- | | | | |
|---|----------------------|----------------|---|
| ➔ | Not Installed | DEFAULT | BIOS is prevented from searching for an IDE disk drive on the specified channel. |
| ➔ | Auto | DEFAULT | The BIOS auto detects the IDE disk drive type attached to the specified channel. This setting should be used if an IDE hard disk drive is attached to the specified channel. |
| ➔ | CD/DVD | | The CD/DVD option specifies that an IDE CD-ROM drive is attached to the specified IDE channel. The BIOS does not attempt to search for other types of IDE disk drives on the specified channel. |

PPC-5xxx-9455 Panel PC

→ **ARMD** This option specifies an ATAPI Removable Media Device. These include, but are not limited to:

ZIP

LS-120

→ **LBA/Large Mode [Auto]**

Use the **LBA/Large Mode** option to disable or enable BIOS to auto detects LBA (Logical Block Addressing). LBA is a method of addressing data on a disk drive. In LBA mode, the maximum drive capacity is 137 GB.

→ **Disabled** BIOS is prevented from using the LBA mode control on the specified channel.

→ **Auto** **DEFAULT** BIOS auto detects the LBA mode control on the specified channel.

→ **Block (Multi Sector Transfer) [Auto]**

Use the **Block (Multi Sector Transfer)** to disable or enable BIOS to auto detect if the device supports multi-sector transfers.

→ **Disabled** BIOS is prevented from using Multi-Sector Transfer on the specified channel. The data to and from the device occurs one sector at a time.

→ **Auto** **DEFAULT** BIOS auto detects Multi-Sector Transfer support on the drive on the specified channel. If supported the data transfer to and from the device occurs multiple sectors at a time.

→ **PIO Mode [Auto]**

Use the **PIO Mode** option to select the IDE PIO (Programmable I/O) mode program timing cycles between the IDE drive and the programmable IDE controller. As the PIO mode increases, the cycle time decreases.

- **Auto** **DEFAULT** BIOS auto detects the PIO mode. Use this value if the IDE disk drive support cannot be determined.
- **0** PIO mode 0 selected with a maximum transfer rate of 3.3 MB/s
- **1** PIO mode 1 selected with a maximum transfer rate of 5.2 MB/s
- **2** PIO mode 2 selected with a maximum transfer rate of 8.3 MB/s
- **3** PIO mode 3 selected with a maximum transfer rate of 11.1 MB/s
- **4** PIO mode 4 selected with a maximum transfer rate of 16.6 MB/s
(This setting generally works with all hard disk drives manufactured after 1999. For other disk drives, such as IDE CD-ROM drives, check the specifications of the drive.)

→ **DMA Mode [Auto]**

Use the **DMA Mode** BIOS selection to adjust the DMA mode options.

- **Auto** **DEFAULT** BIOS auto detects the DMA mode. Use this value if the IDE disk drive support cannot be determined.
- **SWDMA0** Single Word DMA mode 0 selected with a maximum data transfer rate of 2.1 MB/s
- **SWDMA1** Single Word DMA mode 1 selected with a maximum data transfer rate of 4.2 MB/s
- **SWDMA2** Single Word DMA mode 2 selected with a maximum data transfer rate of 8.3 MB/s
- **MWDMA0** Multi Word DMA mode 0 selected with a maximum data transfer rate of 4.2 MB/s
- **MWDMA1** Multi Word DMA mode 1 selected with a maximum data transfer rate of 13.3 MB/s
- **MWDMA2** Multi Word DMA mode 2 selected with a maximum data transfer rate of 16.6 MB/s
- **UDMA1** Ultra DMA mode 0 selected with a maximum data transfer rate of 16.6 MB/s

PPC-5xxx-9455 Panel PC

- ➔ **UDMA1** Ultra DMA mode 1 selected with a maximum data transfer rate of 25 MB/s
- ➔ **UDMA2** Ultra DMA mode 2 selected with a maximum data transfer rate of 33.3 MB/s
- ➔ **UDMA3** Ultra DMA mode 3 selected with a maximum data transfer rate of 44 MB/s (To use this mode, it is required that an 80-conductor ATA cable is used.)
- ➔ **UDMA4** Ultra DMA mode 4 selected with a maximum data transfer rate of 66.6 MB/s (To use this mode, it is required that an 80-conductor ATA cable is used.)
- ➔ **UDMA5** Ultra DMA mode 5 selected with a maximum data transfer rate of 99.9 MB/s (To use this mode, it is required that an 80-conductor ATA cable is used.)

➔ **S.M.A.R.T [Auto]**

Use the **S.M.A.R.T** option to auto-detect, disable or enable Self-Monitoring Analysis and Reporting Technology (SMART) on the drive on the specified channel. **S.M.A.R.T** predicts impending drive failures. The **S.M.A.R.T** BIOS option enables or disables this function.

- ➔ **Auto** **DEFAULT** BIOS auto detects HDD SMART support.
- ➔ **Disabled** Prevents BIOS from using the HDD SMART feature.
- ➔ **Enabled** Allows BIOS to use the HDD SMART feature

➔ **32Bit Data Transfer [Enabled]**

Use the **32Bit Data Transfer** BIOS option to enables or disable 32-bit data transfers.

- ➔ **Disabled** Prevents the BIOS from using 32-bit data transfers.
- ➔ **Enabled** **DEFAULT** Allows BIOS to use 32-bit data transfers on supported hard disk drives.

5.3.3 Floppy Configuration

Use the **Floppy Configuration** menu (BIOS Menu 6) to configure the floppy disk drive connected to the system.

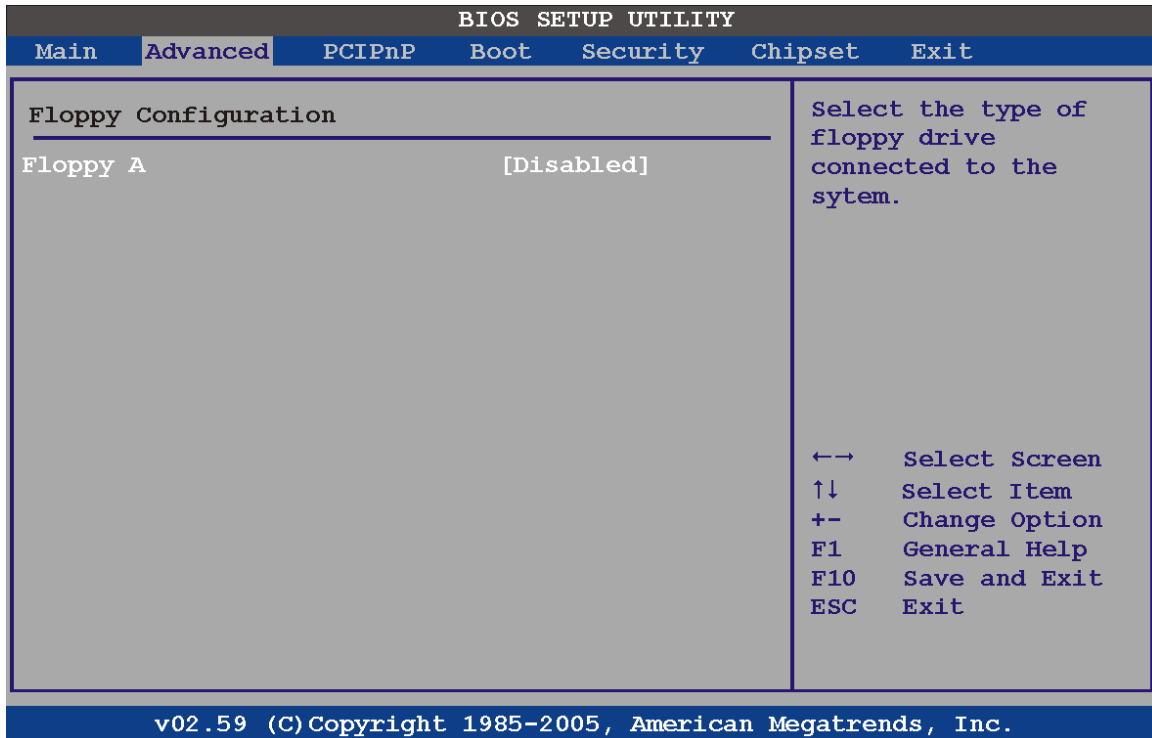

BIOS Menu 6: IDE Master and IDE Slave Configuration

→ Floppy A/B

Use the **Floppy A/B** option to configure the floppy disk drive. Options are listed below:

- Disabled
- 360 KB 5 1/4"
- 1.2 MB 5 1/4"
- 720 KB 3 1/2"
- 1.44 MB 3 1/2"
- 2.88 MB 3 1/2"

PPC-5xxx-9455 Panel PC

5.3.4 Super IO Configuration

Use the **Super IO Configuration** menu (**BIOS Menu 7**) to set or change the configurations for the FDD controllers, parallel ports and serial ports.

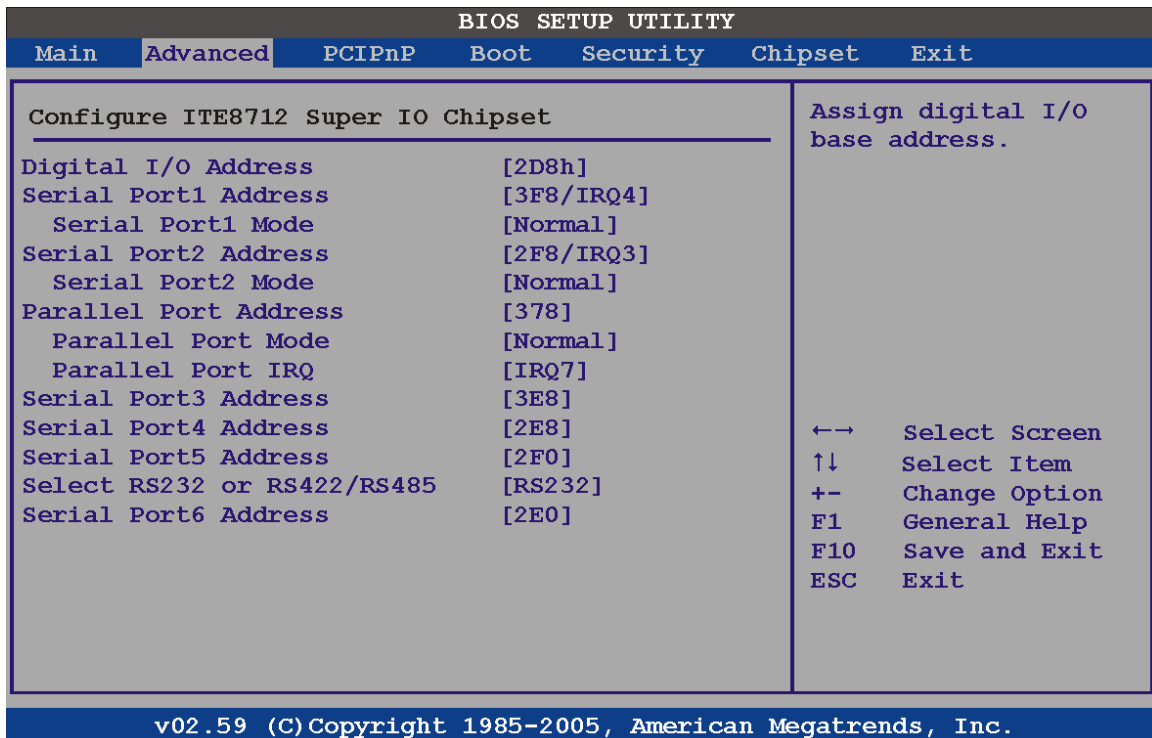

BIOS Menu 7: Super IO Configuration

➔ Digital I/O Address [2D8]

Use the **Digital I/O Address** option to select the digital I/O port base address.

- ➔ **2C0h** **DEFAULT** The digital I/O port address is 2C0h
- ➔ **2C8h** The digital I/O port address is 2C8h
- ➔ **2D0h** The digital I/O port address is 2D0h
- ➔ **2D8h** The digital I/O port address is 2D8h

➔ Serial Port1 Address [3F8/IRQ4]

Use the **Serial Port1 Address** option to select the Serial Port 1 base address.

- ➔ **Disabled** No base address is assigned to Serial Port 1
- ➔ **3F8/IRQ4** **DEFAULT** Serial Port 1 I/O port address is 3F8 and the interrupt address is IRQ4
- ➔ **3E8/IRQ4** Serial Port 1 I/O port address is 3E8 and the interrupt address is IRQ4
- ➔ **2E8/IRQ3** Serial Port 1 I/O port address is 2E8 and the interrupt address is IRQ3

➔ **Serial Port1 Mode [Normal]**

Use the **Serial Port1 Mode** option to select the transmitting and receiving mode for the first serial port.

- ➔ **Normal** **DEFAULT** Serial Port 1 mode is normal
- ➔ **IrDA** Serial Port 1 mode is IrDA
- ➔ **ASK IR** Serial Port 1 mode is ASK IR

➔ **Serial Port2 Address [2F8/IRQ3]**

Use the **Serial Port2 Address** option to select the Serial Port 2 base address.

- ➔ **Disabled** No base address is assigned to Serial Port 2
- ➔ **2F8/IRQ3** **DEFAULT** Serial Port 2 I/O port address is 3F8 and the interrupt address is IRQ3
- ➔ **3E8/IRQ4** Serial Port 2 I/O port address is 3E8 and the interrupt address is IRQ4
- ➔ **2E8/IRQ3** Serial Port 2 I/O port address is 2E8 and the interrupt address is IRQ3

➔ **Serial Port2 Mode [Normal]**

Use the **Serial Port2 Mode** option to select the Serial Port2 operational mode.

- ➔ **Normal** **DEFAULT** Serial Port 2 mode is normal

PPC-5xxx-9455 Panel PC

- IrDA Serial Port 2 mode is IrDA
- ASK IR Serial Port 2 mode is ASK IR

→ Parallel Port Address [Disabled]

Use the **Parallel Port Address** option to select the parallel port base address.

- Disabled No base address is assigned to the Parallel Port
- 378 DEFAULT Parallel Port I/O port address is 378
- 278 Parallel Port I/O port address is 278
- 3BC Parallel Port I/O port address is 3BC

→ Parallel Port Mode [Normal]

Use the **Parallel Port Mode** option to select the mode the parallel port operates in.

- Normal DEFAULT The normal parallel port mode is the standard mode for parallel port operation.
- Bi-directional Parallel port outputs are 8-bits long. Inputs are accomplished by reading 4 of the 8 bits on the status register.
- EPP The parallel port operates in the enhanced parallel port mode (EPP). The EPP mode supports bi-directional communication between the system and the parallel port device and the transmission rates between the two are much faster than the Normal mode.

→ ECP+EPP

The parallel port operates in the extended capabilities port (ECP) mode. The ECP mode supports bi-directional communication between the system and the parallel port device and the transmission rates between the two are much faster than the Normal mode

The parallel port is also be compatible with EPP devices described above

→ Parallel Port IRQ [IRQ7]

Use the **Parallel Port IRQ** selection to set the parallel port interrupt address.

→ IRQ5 IRQ5 is assigned as the parallel port interrupt address

→ IRQ7 **DEFAULT** IRQ7 is assigned as the parallel port interrupt address

→ Serial Port3 Address [3E8]

Use the **Serial Port3 Address** option to select the base addresses for serial port 3

→ Disabled No base address is assigned to serial port 3

→ 3E8 **DEFAULT** Serial port 3 I/O port address is 3E8

→ 2E8 Serial port 3 I/O port address is 2E8

→ 2E0 Serial port 3 I/O port address is 2E0

→ Serial Port4 Address [2E8]

Use the **Serial Port4 IRQ** option to select the interrupt address for serial port 4.

→ Disabled No base address is assigned to serial port 3

→ 3E8 Serial port 4 I/O port address is 3E8

→ 2E8 **DEFAULT** Serial port 4 I/O port address is 2E8

→ 2E0 Serial port 4 I/O port address is 2E0

PPC-5xxx-9455 Panel PC

→ Serial Port5 Address [2F0]

Use the **Serial Port5 IRQ** option to select the interrupt address for serial port 5.

- **Disabled** No base address is assigned to serial port 5
- **3E8** Serial port 5 I/O port address is 3E8
- **2E8** Serial port 5 I/O port address is 2E8
- **2F0** **DEFAULT** Serial port 5 I/O port address is 2F0
- **2E0** Serial port 5 I/O port address is 2E0

→ Select RS232 or RS422/485 [RS/232]

Use the **Select RS232 or RS422/485** option to select the Serial Port 5 signaling mode.

- **RS232** **DEFAULT** Serial Port 2 signaling mode is RS-232
- **RS422/485** Serial Port 2 signaling mode is RS-422 or RS-485

→ Serial Port6 Address [2D8]

Use the **Serial Port6 IRQ** option to select the interrupt address for serial port 6.

- **Disabled** No base address is assigned to serial port 6
- **3E8** Serial port 6 I/O port address is 3E8
- **2E8** Serial port 6 I/O port address is 2E8
- **2F0** Serial port 6 I/O port address is 2F0
- **2E0** **DEFAULT** Serial port 6 I/O port address is 2E0

5.3.5 Hardware Health Configuration

The **Hardware Health Configuration** menu (**BIOS Menu 8**) shows the operating temperature, fan speeds and system voltages.

BIOS SETUP UTILITY	
Main	Advanced
PCIPnP	Boot
Security	Chipset
Power	Exit
Hardware Health Configuration	
CPU FAN1 Mode Setting	[Full On mode]
FAN 1 Mode Setting	[Automatic mode]
Temperature Limit of OFF	[025]
Temperature Limit of Start	[025]
Temperature Limit of Full	[080]
Fan Start PWM	[024]
Slope PWM	[4 PWM]
FAN 2 Mode Setting	[Automatic mode]
Temperature Limit of OFF	[025]
Temperature Limit of Start	[025]
Temperature Limit of Full	[080]
Fan Start PWM	[024]
Slope PWM	[4 PWM]
FAN 3 Mode Setting	[Automatic mode]
Temperature Limit of OFF	[025]
Temperature Limit of Start	[025]
Temperature Limit of Full	[080]
Fan Start PWM	[070]
Slope PWM	[4 PWM]
←→ Select Screen ↑↓ Select Item F1 General Help F10 Save and Exit ESC Exit	
CPU Temperature	:47C/116F
System Temperature #1	:54C/129F
System Temperature #2	:46C/114F
CPU Fan1 Speed	:3729 RPM
Fan1 Speed	:1280 RPM
Fan2 Speed	:N/A
Fan3 Speed	:3479 RPM
CPU Core	:1.296 V
+3.30V	:3.474 V
+5.00V	:4.992 V
+12.0V	:12.480 V
+1.50V	:1.488 V
5VSB	:4.992 V
VBAT	:3.216 V
v02.59 (C) Copyright 1985-2005, American Megatrends, Inc.	

BIOS Menu 8: Hardware Health Configuration

PPC-5xxx-9455 Panel PC

→ CPU FAN 1 Mode Setting [Full On Mode]

Use the **CPU FAN 1 Mode Setting** option to configure the CPU fan.

→ **Full On Mode** **DEFAULT** Fan is on all the time

→ FAN x Mode Setting [Automatic Mode]

Use the **FAN x Mode Setting** option to configure the second fan.

→ **Full On Mode** Fan is on all the time

→ **Automatic mode** **DEFAULT** Fan is off when the temperature is low enough. Parameters must be set by the user.

→ **PWM Manually mode** Pulse width modulation set manually

When the **FAN x Mode Setting** option is in the **Automatic Mode**, the following parameters can be set.

- Temperature Limit of OFF
- Temperature Limit of Start
- Temperature Limit of Full
- Fan Start PWM
- Slope PWM

When the **CPU FAN Mode Setting** option is in the **PWM Manual Mode**, the following parameters can be set.

- CPU Fan PWM control

→ Temperature Limit of OFF [025]



WARNING:

Setting this value too high may cause the fan to stop when the CPU is at a high temperature and therefore cause the system to be damaged.

The **CPU Temp. Limit of OFF** option can only be set if the **FAN x Mode Setting** option is set to **Automatic Mode**. Use the **CPU Temp. Limit of OFF** option to select the CPU temperature at which the cooling fan should automatically turn off. To select a value, select the **CPU Temp. Limit of OFF** option and enter a decimal number between 000 and 127. The temperature range is specified below.

- Minimum Value: 0°C
- Maximum Value: 127°C

→ **Temperature Limit of Start [025]**



WARNING:

Setting this value too high may cause the fan to start only when the CPU is at a high temperature and therefore cause the system to be damaged.

The **Temperature Limit of Start** option can only be set if the **FAN x Mode Setting** option is set to **Automatic Mode**. Use the **Temperature Limit of Start** option to select the CPU temperature at which the cooling fan should automatically turn on. When the fan starts, it rotates using the starting pulse width modulation (PWM) specified in the **Fan Start PWM** option. To select a value, select the **Temperature Limit of Start** option and enter a decimal number between 000 and 127. The temperature range is specified below.

- Minimum Value: 0°C
- Maximum Value: 127°C

→ **Temperature Limit of Full [080]**



WARNING:

Setting this value too high may cause the system to become too hot and cause irreparable damage to the system.

PPC-5xxx-9455 Panel PC

The **Temperature Limit of Full** option can only be set if the **FAN x Mode Setting** option is set to **Automatic Mode**. Use the **Temperature Limit of Full** option to select the CPU temperature at which the cooling will reach full speed. To select a value, select the **Temperature Limit of Full** option and enter a decimal number between 000 and 127. The temperature range is specified below.

- Minimum Value: 0°C
- Maximum Value: 127°C

→ Fan Start PWM [070]

The **Fan Start PWM** option can only be set if the **FAN x Mode Setting** option is set to **Automatic Mode**. Use the **Fan Start PWM** option to select the PWM the fan starts to rotate with after the temperature specified in the **Temperature 3 Limit of Start** is exceeded. To select a value, select the **Fan Start PWM** option and enter a decimal number between 000 and 127. The temperature range is specified below.

- PWM Minimum Mode: 0
- PWM Maximum Mode: 127

→ Slope PWM [4 PWM]

The **Slope PWM** option can only be set if the **FAN x Mode Setting** option is set to **Automatic Mode**. Use the **Slope PWM** option to select the linear rate at which the PWM mode increases with respect to an increase in temperature. A list of available options is shown below:

- 0 PWM
- 1 PWM
- 2 PWM
- 4 PWM
- 8 PWM
- 16 PWM
- 32 PWM
- 64 PWM

The following system parameters and values are shown. The system parameters that are monitored are:

- System Temperatures: The following system temperatures are monitored
 - CPU Temperature
 - System Temperature 1
 - System Temperature 2
- Fan Speeds: The CPU cooling fan speed is monitored.
 - CPU Fan1 Speed
 - Fan 1 Speed
 - Fan 2 Speed
 - Fan 3 Speed
- Voltages: The following system voltages are monitored
 - CPU Core
 - +3.30 V
 - +5.00 V
 - +12.0 V
 - +1.50 V
 - 5 VSB
 - VBAT

PPC-5xxx-9455 Panel PC

5.3.6 Power Configuration

The power configuration menu (BIOS Menu 9) sets the power features options.

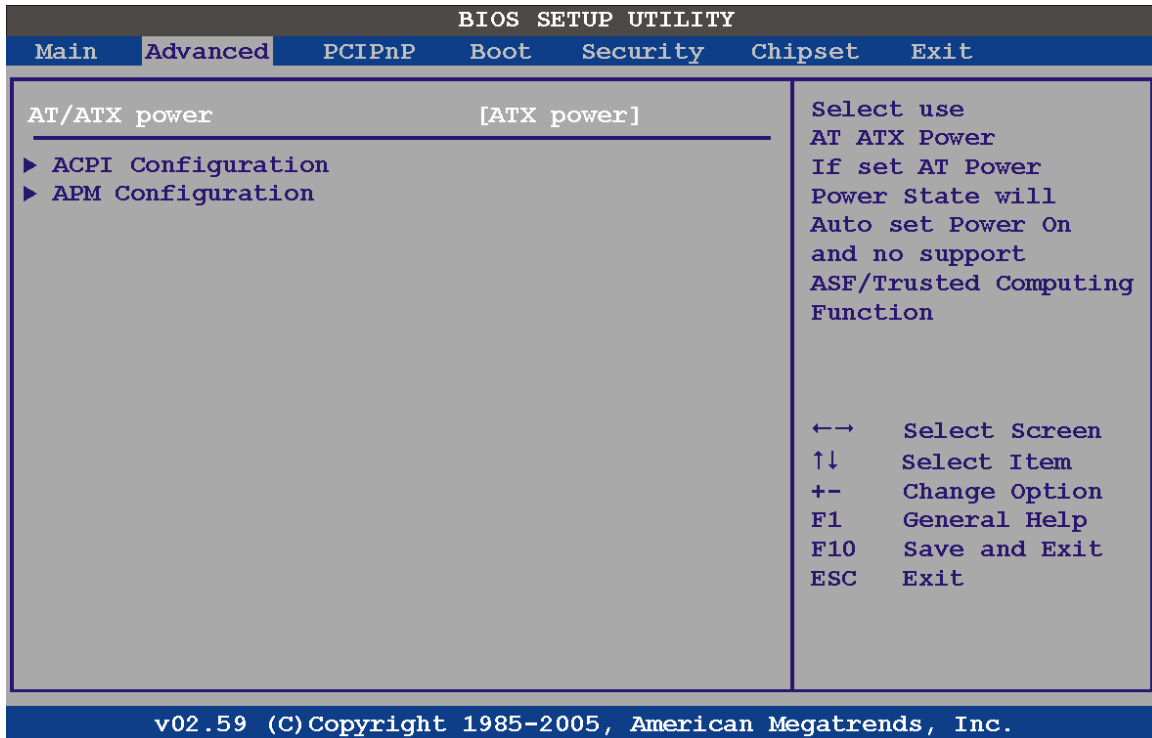

BIOS Menu 9: ACPI Configuration

→ Power Supply Mode [ATX]

Use the **Power Supply Mode** BIOS option to select the power supply that is connected to the system.

- **AT power** An AT power supply is connected to the system and no advanced power management features are enabled.
- **ATX power** **DEFAULT** An ATX power supply is connected to the system and the advanced power management features are enabled.

5.3.6.1 ACPI Configuration

The **ACPI Configuration** menu (**BIOS Menu 10**) configures the Advanced Configuration and Power Interface (ACPI) and Power Management (APM) options.

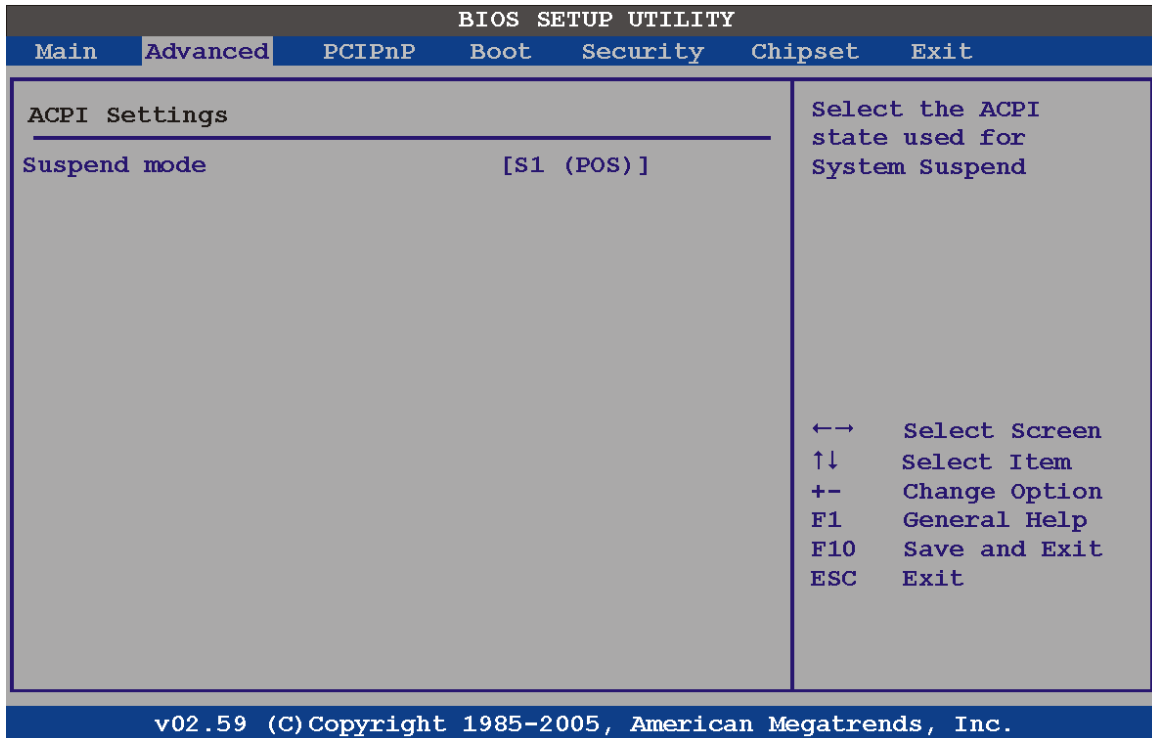

BIOS Menu 10: ACPI Configuration

→ Suspend Mode [S3(STR)]

Use the **Suspend Mode** option to specify the sleep state the system enters when it is not being used.

- **S1 (POS) DEFAULT** The system enters S1(POS) sleep state. The system appears off. The CPU is stopped; RAM is refreshed; the system is running in a low power mode.
- **S3 (STR)** The system enter S3(STR) sleep state. The system appears off. The CPU has no power; RAM is in slow refresh; the power supply is in a reduced power mode. This mode is also referred to as "Save To RAM".

PPC-5xxx-9455 Panel PC

5.3.6.2 APM Configuration

The APM Configuration menu (**BIOS Menu 11**) allows the advanced power management options to be configured.

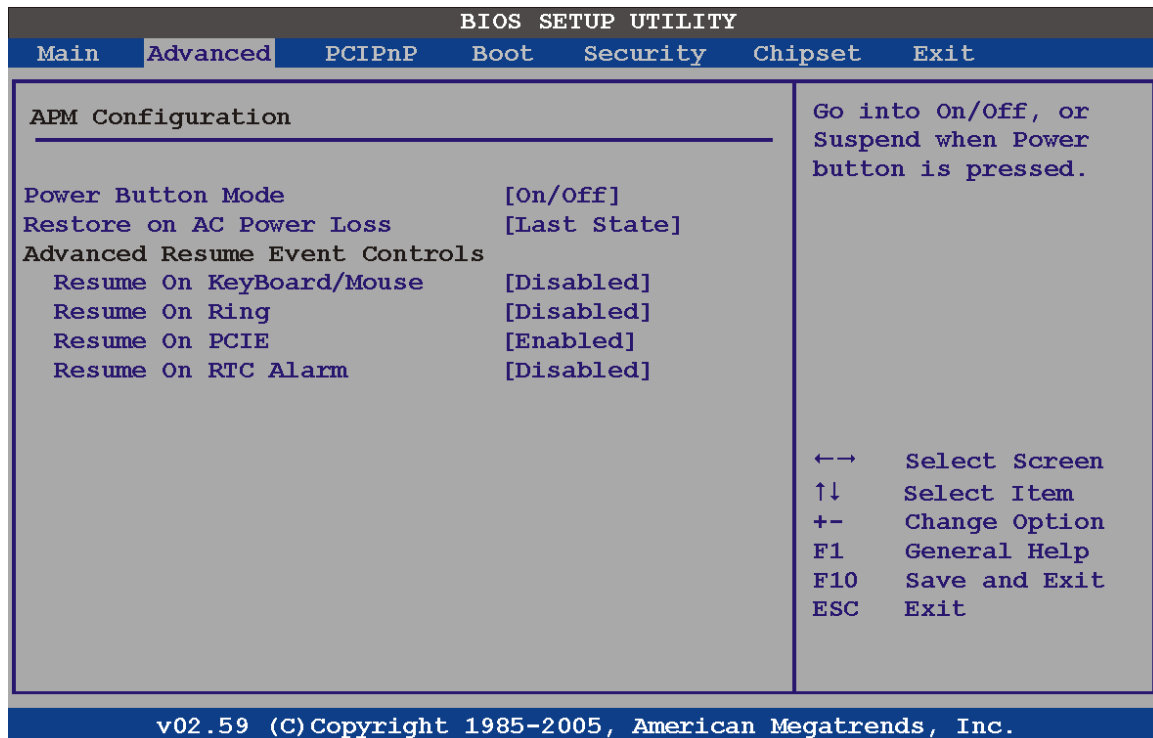

BIOS Menu 11: Advanced Power Management Configuration

→ Power Button Mode [On/Off]

Use the **Power Button Mode** BIOS to specify how the power button functions.

→ **On/Off** **DEFAULT** When the power button is pressed the system is either turned on or off

→ **Suspend** When the power button is pressed the system goes into suspend mode

→ Restore on AC Power Loss [Power Off]

Use the **Restore on AC Power Loss** BIOS option to specify what state the system returns to if there is a sudden loss of power to the system.

- **Power Off** The system remains turned off
- **Power On** The system turns on
- **Last State** **DEFAULT** The system returns to its previous state. If it was on, it turns itself on. If it was off, it remains off.

→ **Resume on Keyboard/Mouse [Disabled]**

Use the **Resume on Keyboard/Mouse** BIOS option to enable activity on either the keyboard or mouse to rouse the system from a suspend or standby state. That is, the system is roused when the mouse is moved or a button on the keyboard is pressed.

- **Disabled** **DEFAULT** Wake event not generated by activity on the keyboard or mouse
- **Enabled** Wake event generated by activity on the keyboard or mouse

→ **Resume on Ring [Disabled]**

Use the **Resume on Ring** BIOS option to enable activity on the RI (ring in) modem line to rouse the system from a suspend or standby state. That is, the system will be roused by an incoming call on a modem.

- **Disabled** **DEFAULT** Wake event not generated by an incoming call
- **Enabled** Wake event generated by an incoming call

→ **Resume on PCIE [Enabled]**

The **Resume on PCI-Express WAKE#** BIOS option specifies if the system is roused from a suspended or standby state when there is activity on the PCI-Express bus.

- **Disabled** Wake event not generated by PCI-Express activity
- **Enabled** **DEFAULT** Wake event generated by PCI-Express activity

PPC-5xxx-9455 Panel PC

→ Resume On RTC Alarm [Disabled]

Use the **Resume On RTC Alarm** option to specify the time the system should be roused from a suspended state.

→ **Disabled** **DEFAULT** The real time clock (RTC) cannot generate a wake event

→ **Enabled** If selected, the following appears with values that can be selected:

RTC Alarm Date (Days)

System Time

After setting the alarm, the computer turns itself on from a suspend state when the alarm goes off.

5.3.7 Remote Access Configuration

Use the **Remote Access Configuration** menu (**BIOS Menu 12**) to configure remote access parameters. The **Remote Access Configuration** is an AMIBIOS feature and allows a remote host running a terminal program to display and configure the BIOS settings.

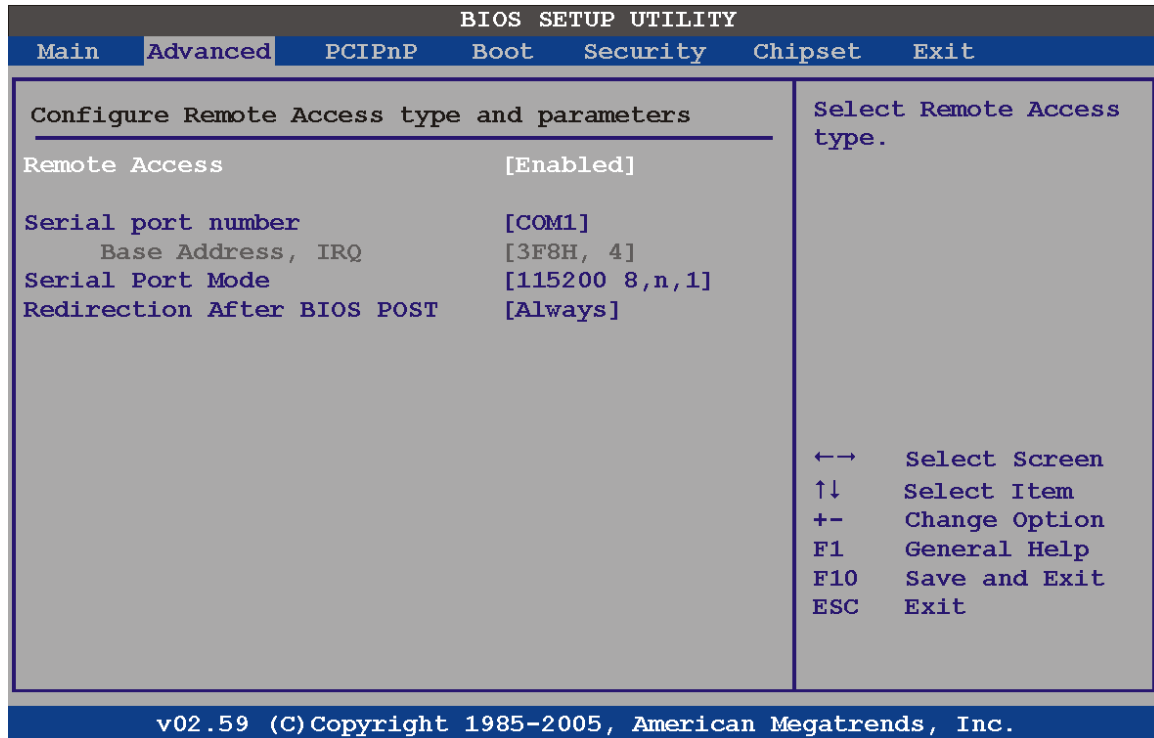

BIOS Menu 12: Remote Access Configuration [Advanced]

→ Remote Access [Disabled]

Use the **Remote Access** option to enable or disable access to the remote functionalities of the system.

→ **Disabled** **DEFAULT** Remote access is disabled.

PPC-5xxx-9455 Panel PC

→ Enabled

Remote access configuration options shown below appear:

Serial Port Number

Serial Port Mode

Flow Control

Redirection after BIOS POST

Terminal Type

VT-UTF8 Combo Key Support

These configuration options are discussed below.

→ Serial Port Number [COM1]

Use the **Serial Port Number** option allows to select the serial port used for remote access.

→ **COM1** **DEFAULT** System is remotely accessed through COM1

→ **COM2** System is remotely accessed through COM2

NOTE: Make sure the selected COM port is enabled through the Super I/O configuration menu.

→ Base Address, IRQ [3F8h,4]

The **Base Address, IRQ** option cannot be configured and only shows the interrupt address of the serial port listed above.

→ Serial Port Mode [115200 8,n,1]

Use the **Serial Port Mode** option to select baud rate through which the console redirection is made. The following configuration options are available

- 115200 8,n,1 DEFAULT
- 57600 8,n,1
- 38400 8,n,1
- 19200 8,n,1
- 09600 8,n,1

**NOTE:**

Identical baud rate setting must be set on the host (a management computer running a terminal software) and the slave

→ Redirection After BIOS POST [Always]

Use the **Redirection After BIOS POST** option to specify when console redirection should occur.

- | | | | |
|---|--------------------|----------------|--|
| → | Disabled | | The console is not redirected after POST |
| → | Boot Loader | | Redirection is active during POST and during Boot Loader |
| → | Always | DEFAULT | Redirection is always active (Some OSES may not work if set to Always) |

PPC-5xxx-9455 Panel PC

5.3.8 USB Configuration

Use the **USB Configuration** menu (**BIOS Menu 13**) to read USB configuration information and configure the USB settings.

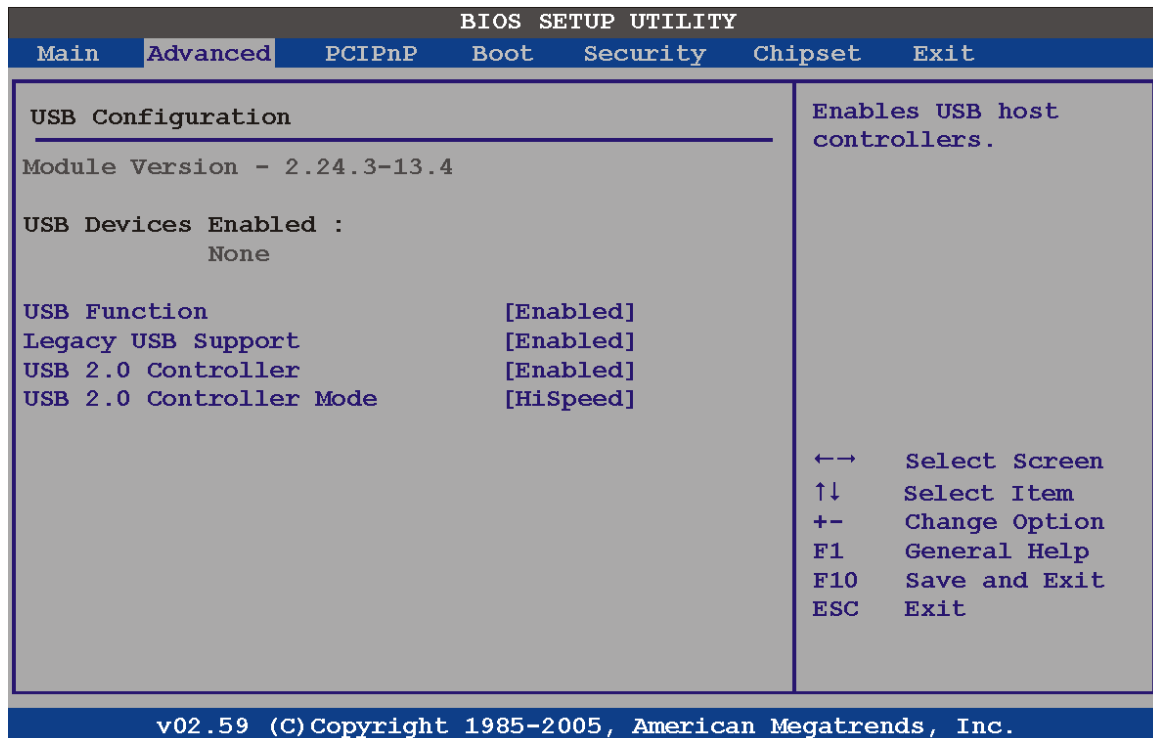

BIOS Menu 13: USB Configuration

→ USB Configuration

The **USB Configuration** field shows the system USB configuration. The items listed are:

- Module Version: x.xxxxx.xxxxx

→ USB Devices Enabled

The **USB Devices Enabled** field lists the USB devices that are enabled on the system

→ USB Function [Enabled]

Use the **USB Function** BIOS option to enable or disable USB function support.

- Disabled USB function support disabled
- Enabled **DEFAULT** USB function support enabled

→ **USB 2.0 Controller [Enabled]**

Use the **USB 2.0 Controller** BIOS option to enable or disable the USB 2.0 controller

- Disabled USB 2.0 controller disabled
- Enabled **DEFAULT** USB 2.0 controller enabled

→ **Legacy USB Support [Enabled]**

Use the **Legacy USB Support** BIOS option to enable USB mouse and USB keyboard support.

Normally if this option is not enabled, any attached USB mouse or USB keyboard does not become available until a USB compatible operating system is fully booted with all USB drivers loaded. When this option is enabled, any attached USB mouse or USB keyboard can control the system even when there is no USB driver loaded onto the system.

- Disabled Legacy USB support disabled
- Enabled **DEFAULT** Legacy USB support enabled
- Auto Legacy USB support disabled if no USB devices are connected

→ **USB 2.0 Controller Mode [FullSpeed]**

Use the **USB2.0 Controller Mode** option to set the speed of the USB2.0 controller.

- FullSpeed **DEFAULT** The controller is capable of operating at 12 Mb/s
- HiSpeed The controller is capable of operating at 480 Mb/s

5.3.8.1 USB Mass Storage Device Configuration

Use the **USB Mass Storage Device Configuration** menu (**BIOS Menu 14**) to configure USB mass storage class devices.

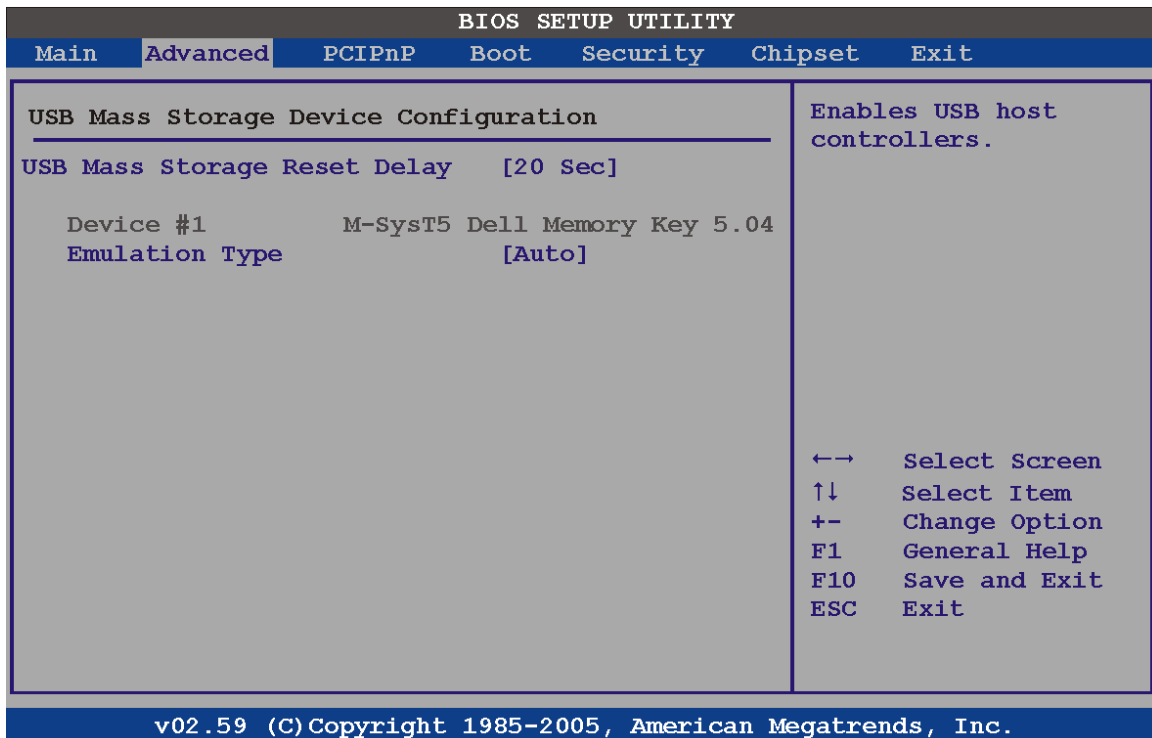

BIOS Menu 14: USB Mass Storage Device Configuration

➔ USB Mass Storage Reset Delay [20 Sec]

Use the **USB Mass Storage Reset Delay** option to set the number of seconds POST waits for the USB mass storage device after the start unit command.

- ➔ **10 Sec** POST waits 10 seconds for the USB mass storage device after the start unit command.
- ➔ **20 Sec** **DEFAULT** POST waits 20 seconds for the USB mass storage device after the start unit command.
- ➔ **30 Sec** POST waits 30 seconds for the USB mass storage device after the start unit command.

PPC-5xxx-9455 Panel PC

→ CDROM

Assumes the CD-ROM is formatted as bootable media. All the devices that support block sizes greater than 512 bytes can only be booted using this option.

5.4 PCI/PnP

Use the **PCI/PnP** menu (**BIOS Menu 15**) to configure advanced PCI and PnP settings.



WARNING!

Setting wrong values for the BIOS selections in the PCIPnP BIOS menu may cause the system to malfunction.

BIOS SETUP UTILITY			
Main	Advanced	PCIPnP	Boot Security Chipset Exit
Advanced PCI/PnP Settings			Available: Specified IRQ is available to be use by PCI/PnP devices.
IRQ3		[Reserved]	Reserved: Specified IRQ is reserved for use by legacy ISA devices.
IRQ4		[Reserved]	
IRQ5		[Available]	
IRQ7		[Available]	
IRQ9		[Available]	
IRQ10		[Reserved]	
IRQ11		[Available]	
IRQ14		[Available]	
IRQ15		[Available]	
DMA Channel 0		[Available]	←→ Select Screen
DMA Channel 1		[Available]	↑↓ Select Item
DMA Channel 3		[Available]	+ - Change Option
DMA Channel 5		[Available]	F1 General Help
DMA Channel 6		[Available]	F10 Save and Exit
DMA Channel 7		[Available]	ESC Exit
Reserved Memory Size		[Disabled]	

v02.59 (C) Copyright 1985-2005, American Megatrends, Inc.

BIOS Menu 15: PCI/PnP Configuration

→ IRQ# [Available]

Use the **IRQ#** address to specify what IRQs can be assigned to a particular peripheral device.

→ Available **DEFAULT** The specified IRQ is available to be used by PCI/PnP devices

→ Reserved The specified IRQ is reserved for use by Legacy ISA devices

Available IRQ addresses are:

- IRQ3
- IRQ4
- IRQ5
- IRQ7
- IRQ9
- IRQ10
- IRQ 11
- IRQ 14
- IRQ 15

→ DMA Channel# [Available]

Use the **DMA Channel#** option to assign a specific DMA channel to a particular PCI/PnP device.

→ Available **DEFAULT** The specified DMA is available to be used by PCI/PnP devices

→ Reserved The specified DMA is reserved for use by Legacy ISA devices

Available DMA Channels are:

- DM Channel 0
- DM Channel 1
- DM Channel 3

PPC-5xxx-9455 Panel PC

- DM Channel 5
- DM Channel 6
- DM Channel 7

➔ Reserved Memory Size [Disabled]

Use the **Reserved Memory Size** BIOS option to specify the amount of memory that should be reserved for legacy ISA devices.

- ➔ **Disabled** **DEFAULT** No memory block reserved for legacy ISA devices
- ➔ **16K** 16 KB reserved for legacy ISA devices
- ➔ **32K** 32 KB reserved for legacy ISA devices
- ➔ **64K** 54 KB reserved for legacy ISA devices

5.5 Boot

Use the **Boot** menu (**BIOS Menu 16**) to configure system boot options.

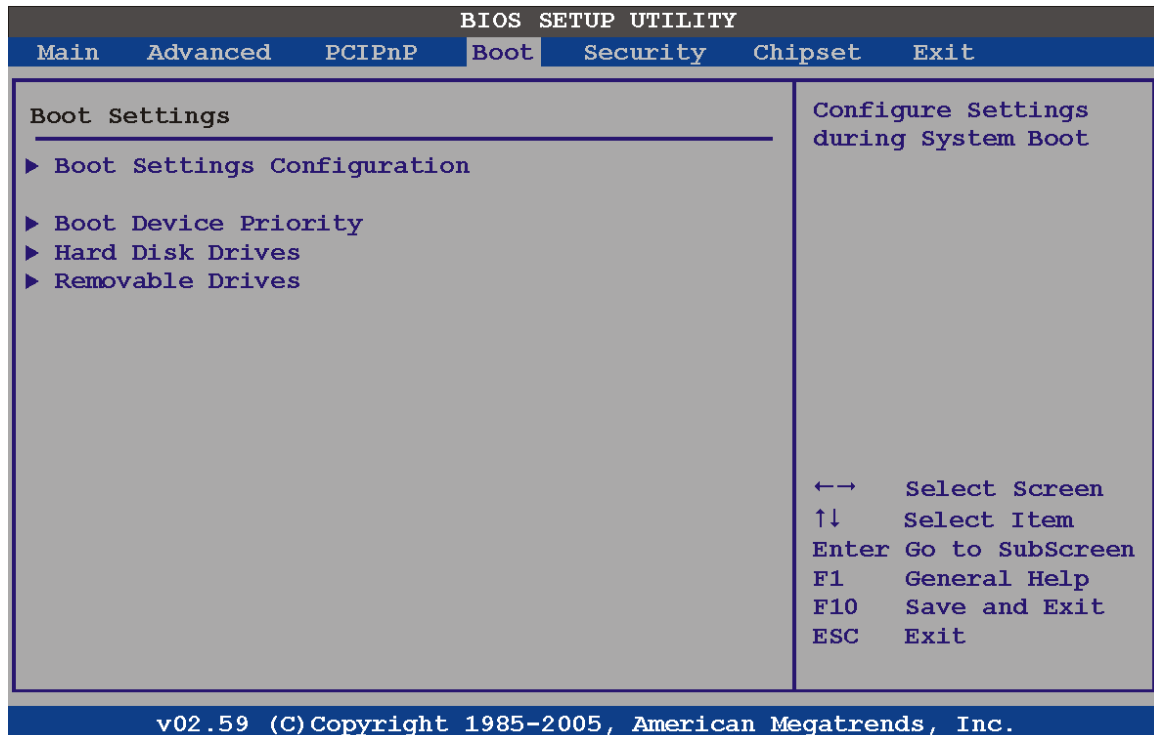

BIOS Menu 16: Boot

5.5.1 Boot Settings Configuration

Use the **Boot Settings Configuration** menu (BIOS Menu 17) to configure advanced system boot options.

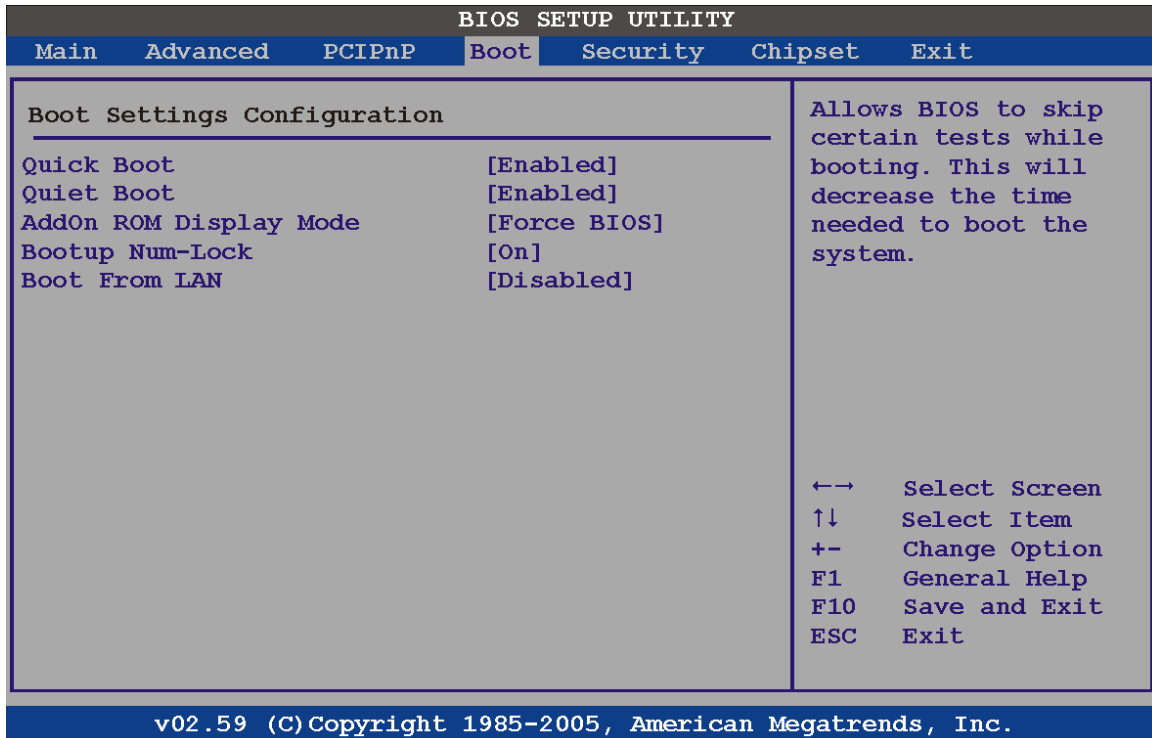

BIOS Menu 17: Boot Settings Configuration

→ Quick Boot [Enabled]

Use the **Quick Boot** BIOS option to make the computer speed up the boot process.

- **Disabled** No POST procedures are skipped
- **Enabled** **DEFAULT** Some POST procedures are skipped to decrease the system boot time

→ Quiet Boot [Enabled]

Use the **Quiet Boot** BIOS option to select the screen display when the system boots.

- **Disabled** Normal POST messages displayed

PPC-5xxx-9455 Panel PC

→ **Enabled** **DEFAULT** OEM Logo displayed instead of POST messages

→ **AddOn ROM Display Mode [Force BIOS]**

Use the **AddOn ROM Display Mode** option to allow add-on ROM (read-only memory) messages to be displayed.

→ **Force BIOS** **DEFAULT** The system forces third party BIOS to display during system boot.

→ **Keep Current** The system displays normal information during system boot.

→ **Bootup Num-Lock [On]**

Use the **Bootup Num-Lock** BIOS option to specify if the number lock setting must be modified during boot up.

→ **Off** Does not enable the keyboard Number Lock automatically. To use the 10-keys on the keyboard, press the Number Lock key located on the upper left-hand corner of the 10-key pad. The Number Lock LED on the keyboard lights up when the Number Lock is engaged.

→ **On** **DEFAULT** Allows the Number Lock on the keyboard to be enabled automatically when the computer system boots up. This allows the immediate use of the 10-key numeric keypad located on the right side of the keyboard. To confirm this, the Number Lock LED light on the keyboard is lit.

→ **Boot From LAN Support [Disabled]**

Use the **BOOT From LAN Support** option to enable the system to be booted from a remote system.

→ **Disabled** **DEFAULT** Cannot be booted from a remote system through the LAN

→ Enabled DEFAULT Can be booted from a remote system through the LAN

5.5.2 Boot Device Priority

Use the **Boot Device Priority** menu (BIOS Menu 18) to specify the boot sequence from the available devices. Possible boot devices may include:

- HDD
- CD/DVD
- USB

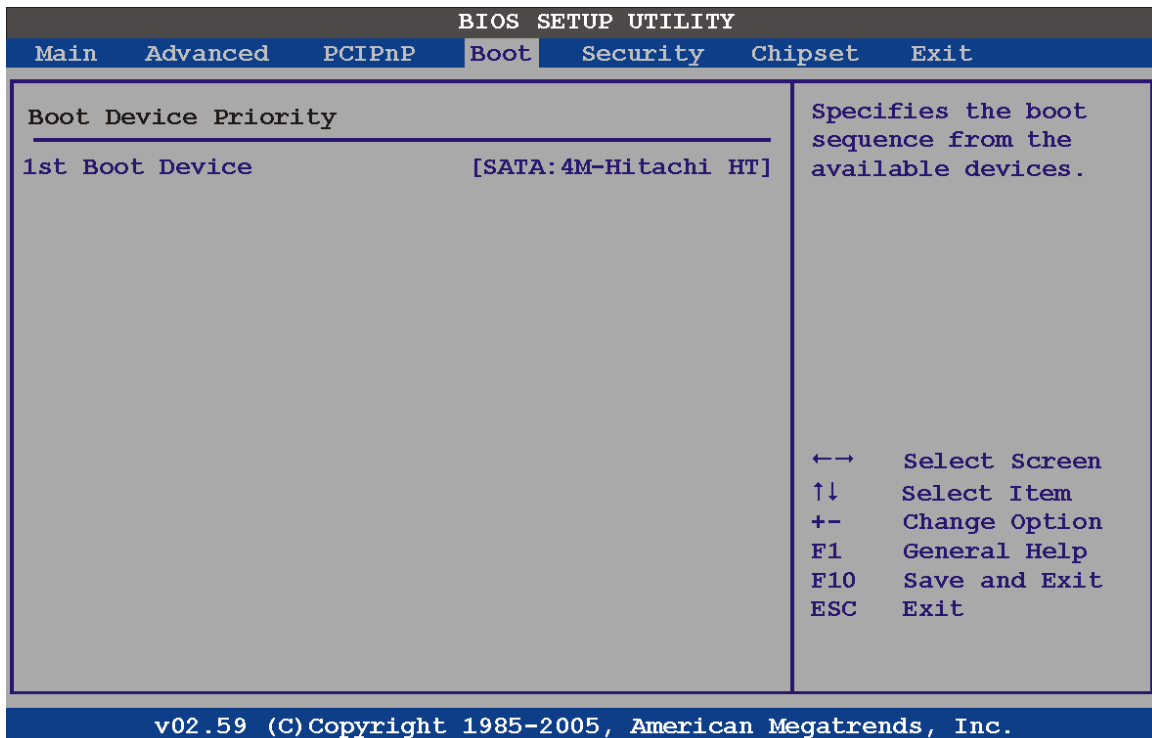

BIOS Menu 18: Boot Device Priority Settings

5.5.3 Hard Disk Drives

Use the **Hard Disk Drives** menu to specify the boot sequence of the available HDDs. When the menu is opened, the HDDs connected to the system are listed as shown below:

- 1st Drive [HDD: PM-(part number)]
- 2nd Drive [HDD: PS-(part number)]

PPC-5xxx-9455 Panel PC

- 3rd Drive [HDD: SM-(part number)]
- 4th Drive [HDD: SM-(part number)]



NOTE:

Only the drives connected to the system are shown. For example, if only two HDDs are connected only “1st Drive” and “2nd Drive” are listed.

The boot sequence from the available devices is selected. If the “1st Drive” option is selected a list of available HDDs is shown. Select the first HDD the system boots from. If the “1st Drive” is not used for booting this option may be disabled.

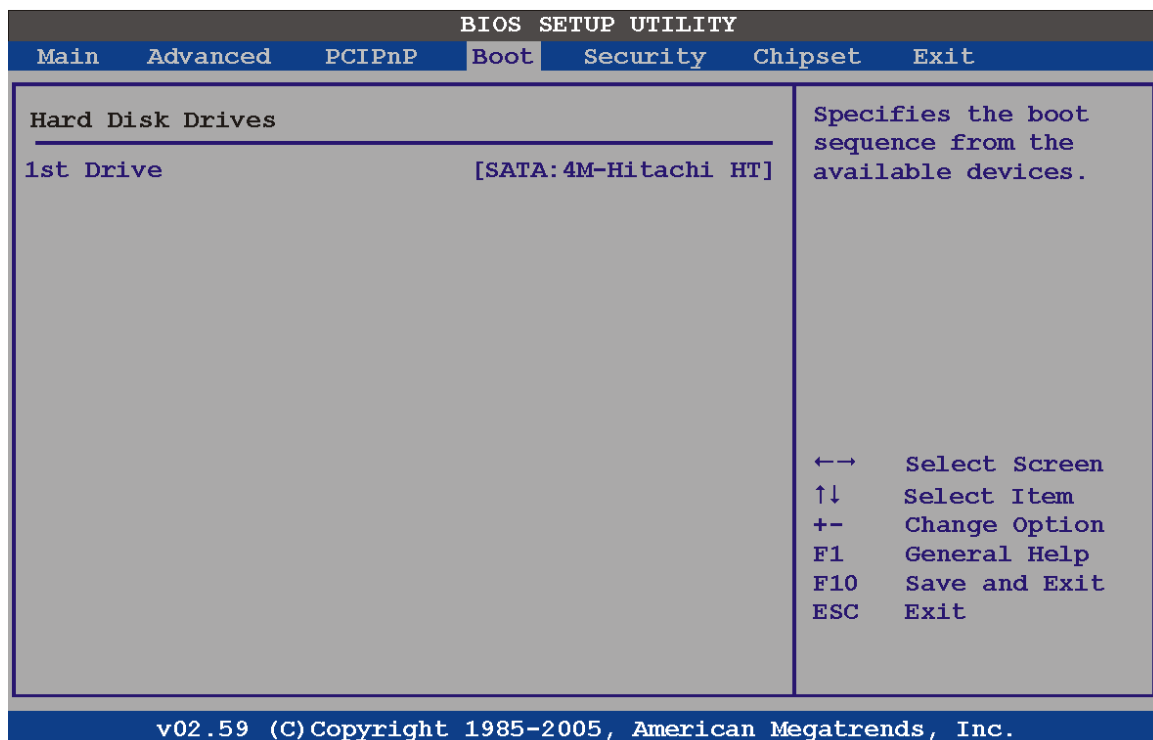

BIOS Menu 19: Hard Disk Drives

5.5.4 CD/DVD Drives

Use the **CD/DVD Drives** menu to specify the boot sequence of the available CD/DVD drives. When the menu is opened, the CD drives and DVD drives connected to the system are listed as shown below:

- 1st Drive [CD/DVD: PM-(part ID)]
- 2nd Drive [HDD: PS-(part ID)]
- 3rd Drive [HDD: SM-(part ID)]
- 4th Drive [HDD: SM-(part ID)]



NOTE:

Only the drives connected to the system are shown. For example, if only two CDs or DVDs are connected only “**1st Drive**” and “**2nd Drive**” are listed.

The boot sequence from the available devices is selected. If the “**1st Drive**” option is selected a list of available CD/DVD drives is shown. Select the first CD/DVD drive the system boots from. If the “**1st Drive**” is not used for booting this option may be disabled.

PPC-5xxx-9455 Panel PC

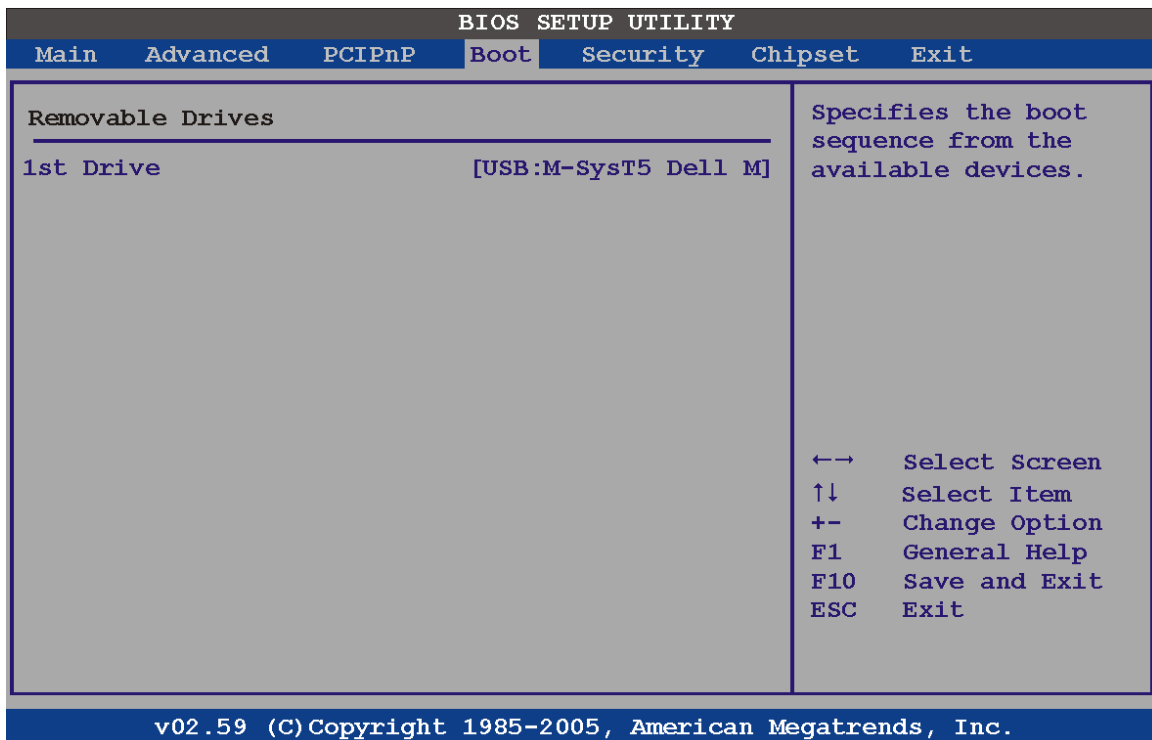

BIOS Menu 20: CD/DVD Drives

5.6 Security

Use the Security menu (**BIOS Menu 21**) to set system and user passwords.

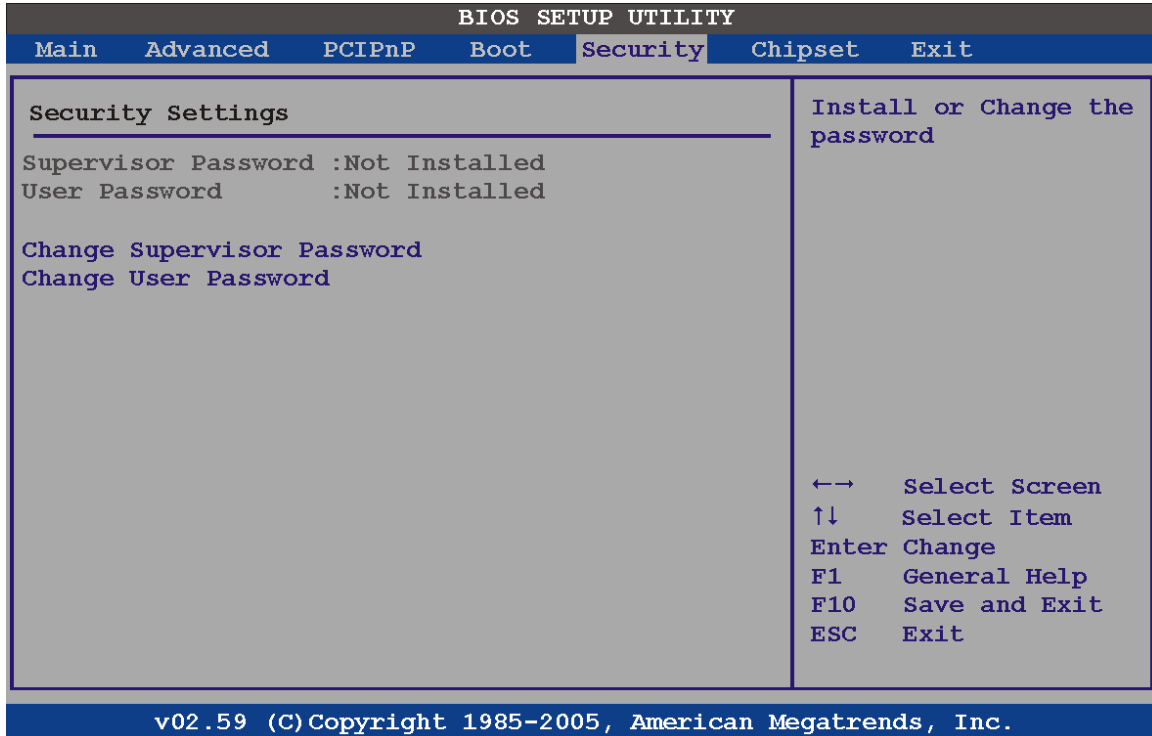

BIOS Menu 21: Security

→ Change Supervisor Password

Use the **Change Supervisor Password** to set or change a supervisor password. The default for this option is **Not Installed**. If a supervisor password must be installed, select this field and enter the password. After the password has been added, **Install** appears next to **Change Supervisor Password**.

→ Change User Password

Use the **Change User Password** to set or change a user password. The default for this option is **Not Installed**. If a user password must be installed, select this field and enter the password. After the password has been added, **Install** appears next to **Change User Password**.

5.7 Chipset

Use the **Chipset** menu (**BIOS Menu 22**) to access the Northbridge and Southbridge configuration menus



WARNING!

Setting the wrong values for the Chipset BIOS selections in the Chipset BIOS menu may cause the system to malfunction.

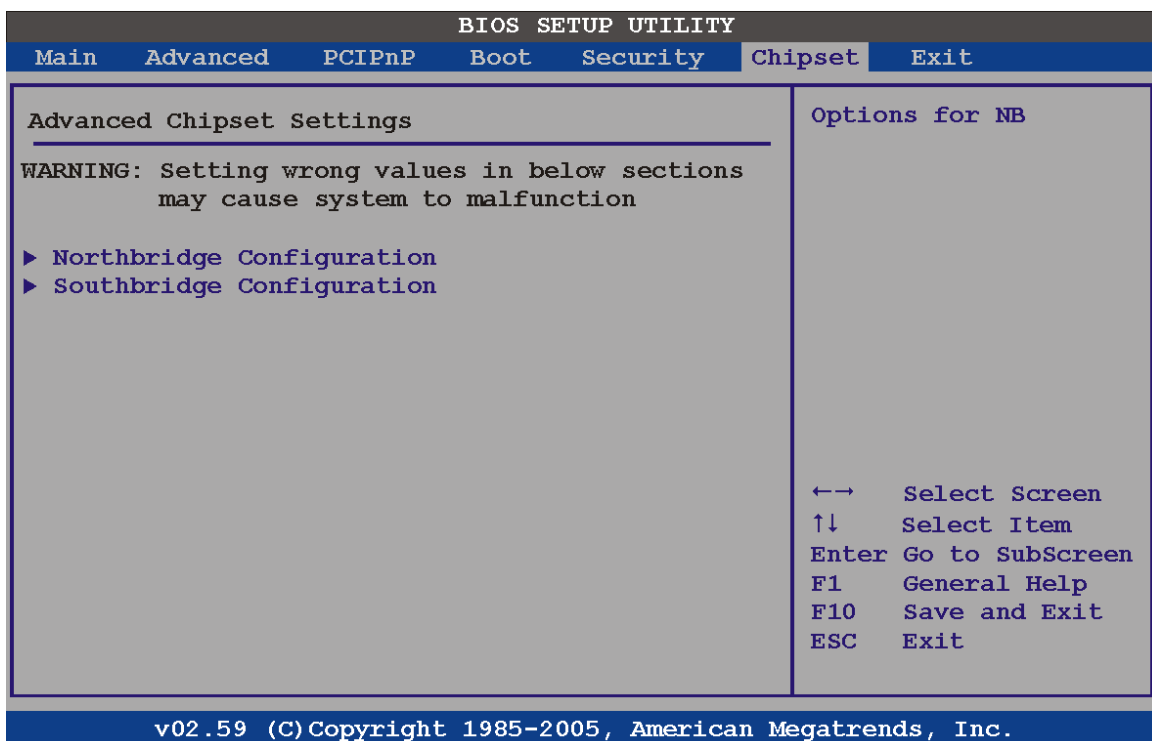

BIOS Menu 22: Chipset

5.7.1 Northbridge Configuration

Use the Northbridge Configuration menu (**BIOS Menu 22**) to configure the Northbridge chipset.

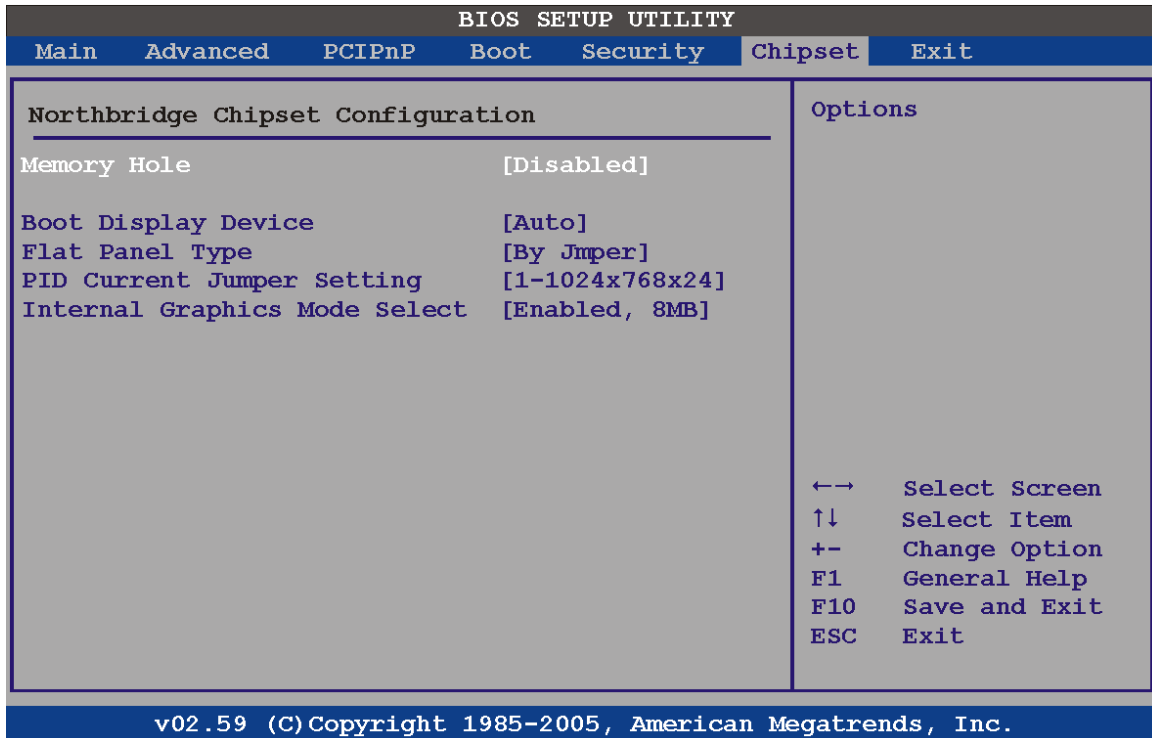

BIOS Menu 23:Northbridge Chipset Configuration

➔ Memory Hole [Disabled]

Use the **Memory Hole** option to reserve memory space between 15 MB and 16 MB for ISA expansion cards that require a specified area of memory to work properly. If an older ISA expansion card is used, please refer to the documentation that came with the card to see if it is necessary to reserve the space.

- ➔ **Disabled** **DEFAULT** Memory is not reserved for ISA expansion cards
- ➔ **15 MB – 16 MB** Between 15 MB and 16 MB of memory is reserved for ISA expansion cards

PPC-5xxx-9455 Panel PC

→ Boot Display Device

Use the **Boot Display Device** option to select the display device used by the system when it boots. Configuration options are listed below.

- Auto
- CRT - Default
- TV
- LFP
- CRT + LFP

→ Flat Panel Type [By Jumper]

Use the **Flat Panel Type** is set using the onboard jumper settings. The jumper settings can be found in the Installation and Configuration chapter.

→ PID Current Jumper Setting [1-1024x768x24]

The **PID Current Jumper Setting** shows the current setting of the flat panel resolution jumper.

→ Internal Graphics Mode Select [Enable, 8 MB]

Use the **Internal Graphic Mode Select** option to specify the amount of system memory that can be used by the Internal graphics device.

- **Disable**
- **Enable, 1 MB** 1 MB of memory used by internal graphics device
- **Enable, 8 MB** **DEFAULT** 8 MB of memory used by internal graphics device
- **Disabled** Scaling is disabled

5.7.2 Southbridge Configuration

The Southbridge Configuration menu (**BIOS Menu 24**) allows the Southbridge chipset to be configured.

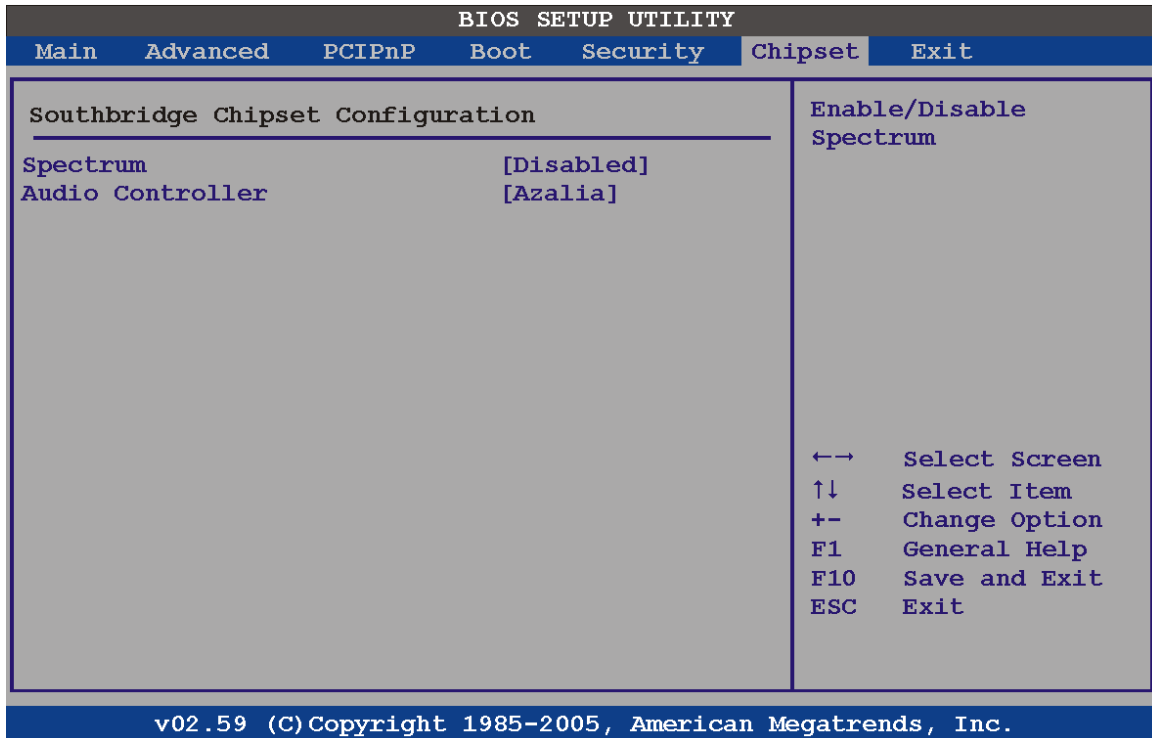

BIOS Menu 24: Southbridge Chipset Configuration

→ Spectrum [Disabled]

Use the **Spectrum** option to reduce the EMI. Excess EMI is generated when the system clock generator pulses have extreme values. Spreading the pulse spectrum modulates changes in the extreme values from spikes to flat curves, thus reducing the EMI. This benefit may in some cases be outweighed by problems with timing-critical devices, such as a clock-sensitive SCSI device.

- **Disabled** DEFAULT EMI not reduced
- **Enabled** EMI reduced

PPC-5xxx-9455 Panel PC

→ Audio Controller [Azalia]

Use the **Audio Controller Selection** option to enable or disable the High Definition Audio CODEC.

- **Disabled** The onboard HD Audio is disabled
- **Azalia** **DEFAULT** The onboard HD Audio is enabled

5.8 Exit

Use the **Exit** menu (**BIOS Menu 25**) to load default BIOS values, optimal failsafe values and to save configuration changes.

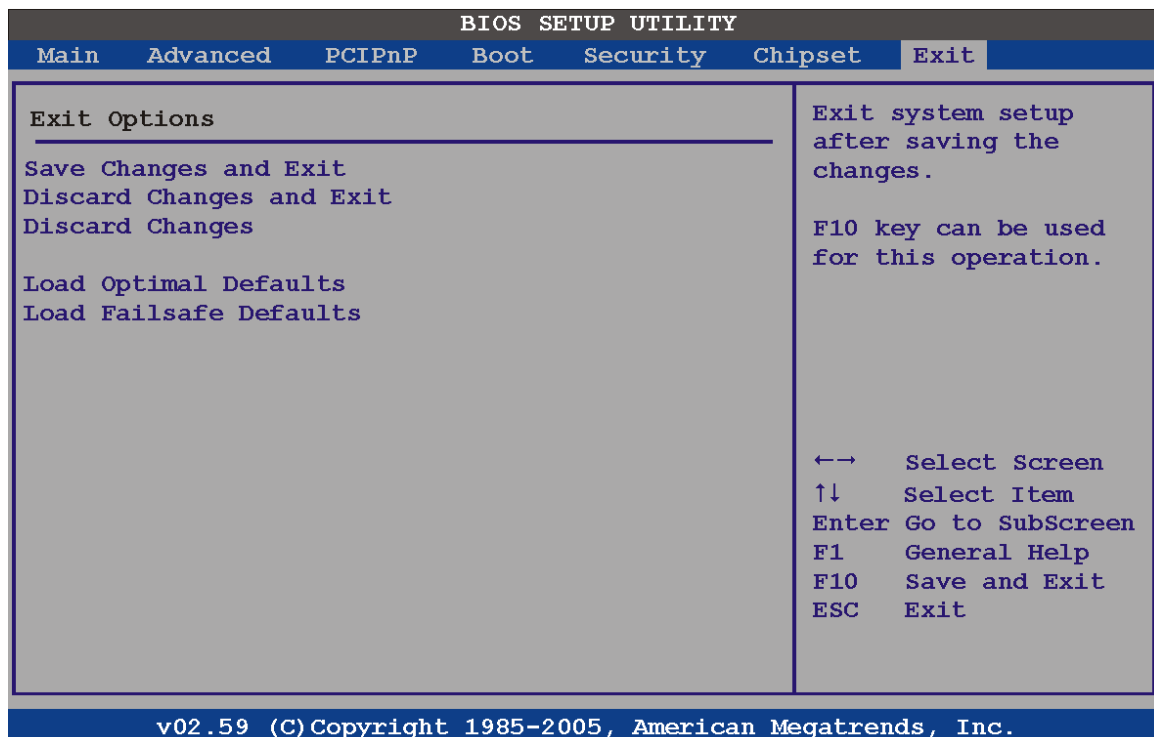

BIOS Menu 25:Exit

→ Save Changes and Exit

Use the **Save Changes and Exit** option to save the changes made to the BIOS options and to exit the BIOS configuration setup program.

→ **Discard Changes and Exit**

Use the **Discard Changes and Exit** option to exit the BIOS configuration setup program without saving the changes made to the system.

→ **Discard Changes**

Use the **Discard Changes** option to discard the changes and remain in the BIOS configuration setup program.

→ **Load Optimal Defaults**

Use the **Load Optimal Defaults** option to load the optimal default values for each of the parameters on the Setup menus. **F9 key can be used for this operation.**

→ **Load Failsafe Defaults**

Use the **Load Failsafe Defaults** option to load failsafe default values for each of the parameters on the Setup menus. **F8 key can be used for this operation.**

Chapter

6

Software Installation

6.1 Available Software Drivers



NOTE:

The content of the CD may vary throughout the life cycle of the product and is subject to change without prior notice. You may visit the IEI website or contact technical support for the latest updates.

The following drivers can be installed on the system.

- Chipset driver
- VGA driver
- Gigabit Ethernet driver
- Audio Driver

Installation instructions are given below.

6.2 Chipset Driver

To install the chipset driver, please follow the steps below.

Step 1: Browse to the **NB** directory on the installation CD (Figure 6-1).

PPC-5xxx-9455 Panel PC

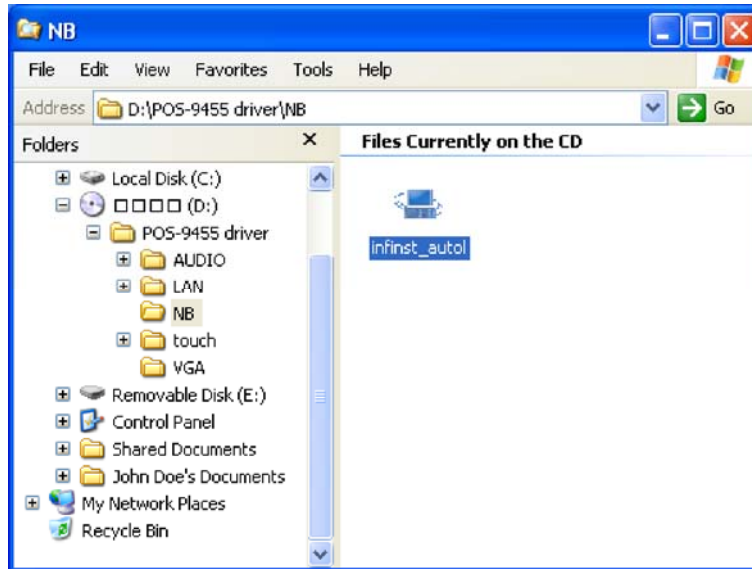

Figure 6-1: Chipset Driver Installation Program

Step 2: Double-click the **infinst_Autol.exe** icon.

Step 3: The welcome screen in Figure 6-2 appears.



Figure 6-2: Chipset Driver Installation Welcome Screen

Step 4: Click **NEXT** to continue the installation process.

Step 5: The license agreement in Figure 6-3 appears.



Figure 6-3: Chipset Driver Installation License Agreement

Step 6: Read the license agreement. To accept the terms and conditions stipulated in the agreement, click **YES**.

Step 7: The Readme file in Figure 6-4 appears.



Figure 6-4: Chipset Driver Readme File Information

PPC-5xxx-9455 Panel PC

Step 8: Read the Readme file information and then click **NEXT** to start the driver installation.

Step 9: The **Setup Progress** windows appears (Figure 6-5).



Figure 6-5: Chipset Driver Installation Complete

Step 10: After the driver installation process is complete click **NEXT** to continue

Step 11: The **Setup is Complete** windows appears (Figure 6-6).



Figure 6-6: Chipset Driver Installation Complete

Step 12: The computer must be restarted for changes to take effect. Select “**Yes, I want to restart this computer now,**” to restart the computer when finished, or “**No, I will restart this computer later,**” to manually restart the computer later. Click **FINISH** to complete the driver installation.

6.3 Graphics Driver

To install the graphics driver, please follow the steps below.

Step 1: Browse to the **VGA** folder on the installation CD (Figure 6-7).

PPC-5xxx-9455 Panel PC

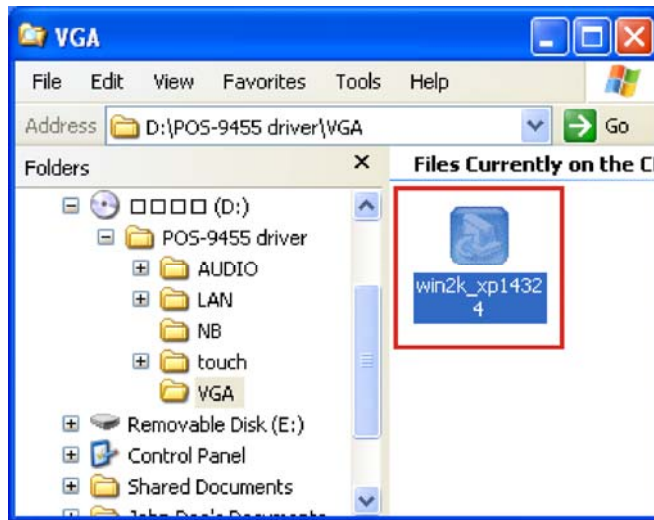

Figure 6-7: Graphics Setup Icon

Step 2: Double-click the setup icon to start the graphics driver installation (Figure 6-7).

Step 3: A new window appears with a detailed explanation of what is contained in the graphics driver file (Figure 6-8).

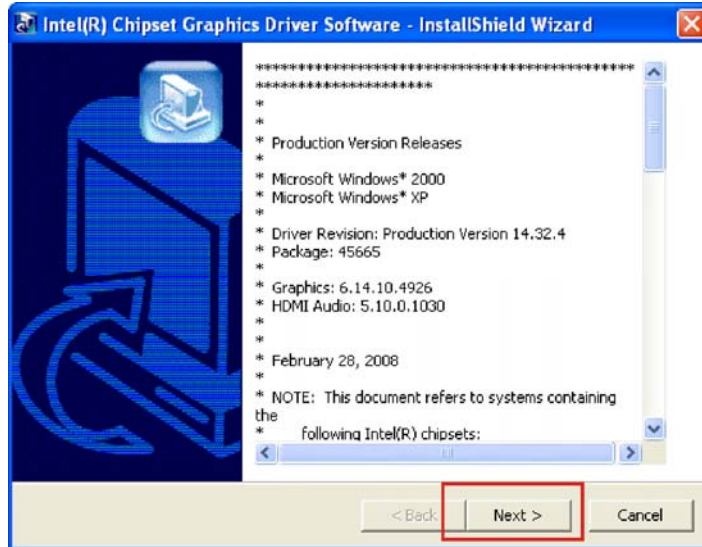

Figure 6-8: VGA Driver

Step 4: Click **NEXT** to continue the driver installation process (Figure 6-8).

Step 5: The Graphics driver welcome screen appears (Figure 6-9).



Figure 6-9: Graphics Driver Installation

Step 6: Click **NEXT** to continue the driver installation (Figure 6-9).

Step 7: The license agreement appears (Figure 6-10).

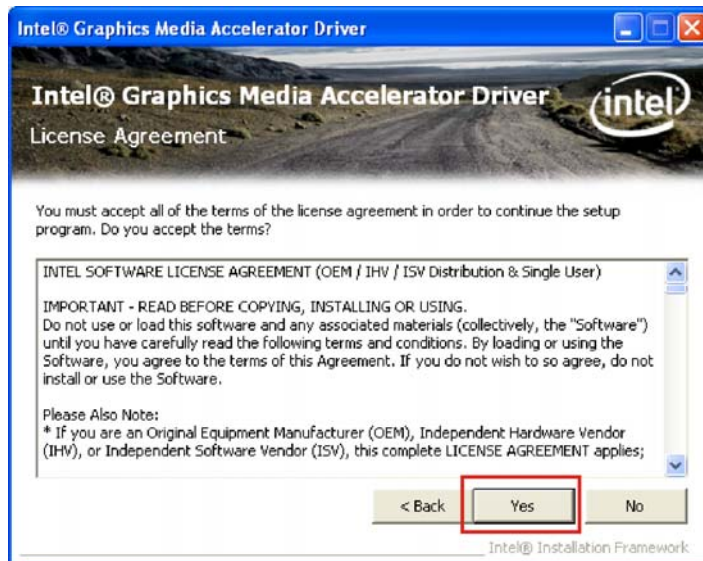

Figure 6-10: Graphics Driver License Agreement

PPC-5xxx-9455 Panel PC

Step 8: Read the license agreement carefully. Click **YES** to accept the terms of the license agreement and continue installation.

Step 9: A new window appears with details of the drivers to be installed (Figure 6-11).

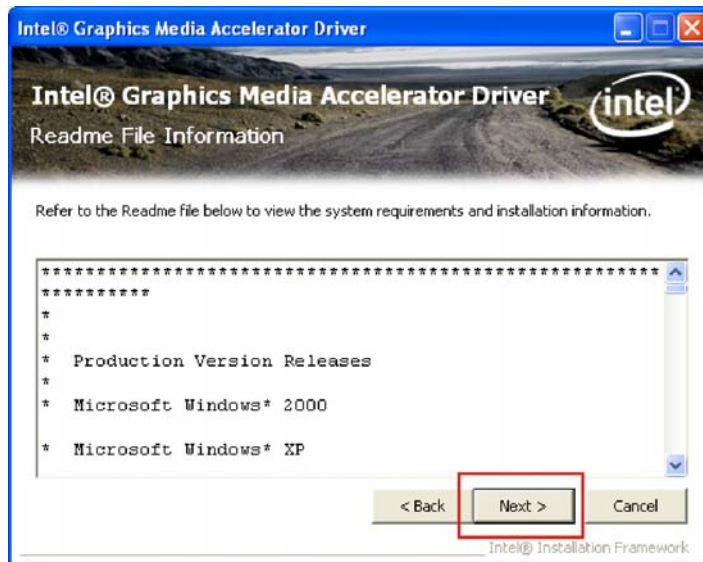

Figure 6-11: Graphics Driver Readme file

Step 10: Click **NEXT** to start installing the graphics drivers.

Step 11: The driver installation progress window appears and shows details for each of the drivers as they are installed (Figure 6-12).

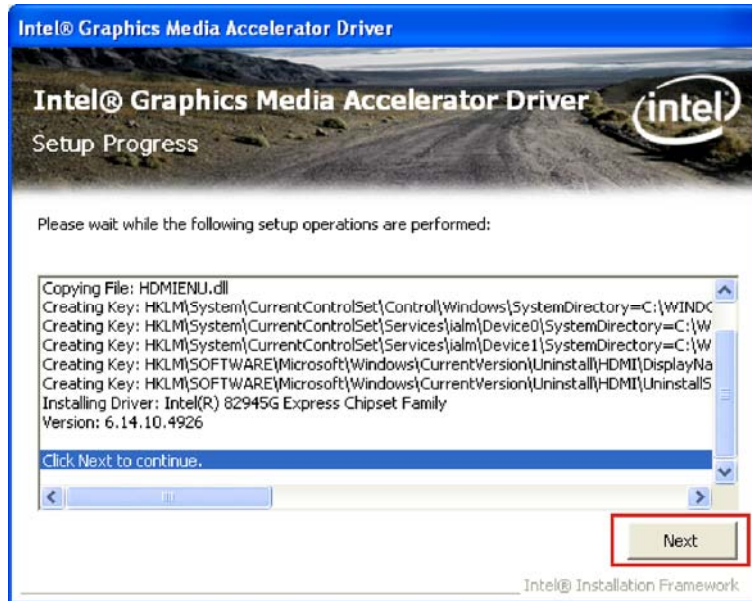

Figure 6-12: Graphics Driver Installation Notice

Step 12: The **Setup is Complete** window appears. (Figure 6-13).



Figure 6-13: Graphics Driver Installation Complete

PPC-5xxx-9455 Panel PC

Step 13: The confirmation screen offers the option of restarting the computer now or later.

For the settings to take effect, the computer must be restarted. Click **FINISH** to restart the computer.

6.4 Gigabit Ethernet Driver Installation

To install the Gigabit Ethernet driver, please follow the steps below.

Step 1: Open **Windows Control Panel** (Figure 6-14).

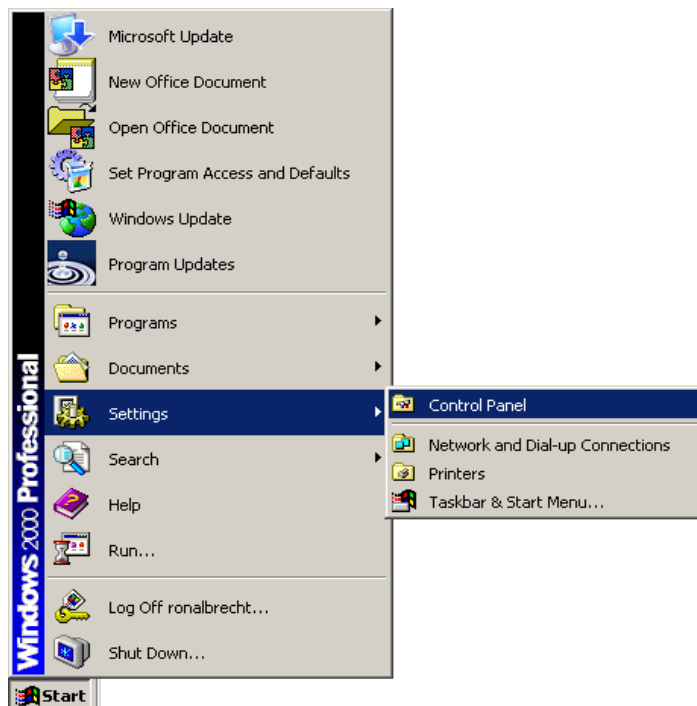

Figure 6-14: Windows Control Panel

Step 2: Double-click the **System** icon (Figure 6-15).



Figure 6-15: System Icon

Step 3: Select the Hardware tab and click the **DEVICE MANAGER** tab (Figure 6-16).

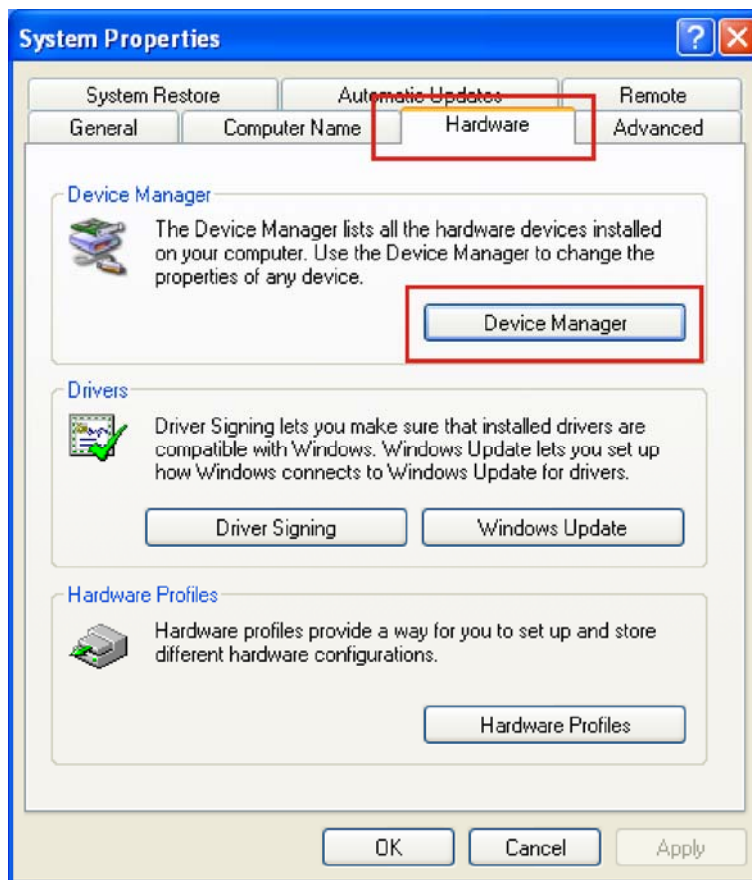

Figure 6-16: Device Manager Tab

PPC-5xxx-9455 Panel PC

Step 4: Right-click the “Ethernet Controller” and select “Update Driver...” to start the driver update process (Figure 6-17).



Figure 6-17: Device Manager List

Step 5: The Device Driver Wizard appears (Figure 6-18).

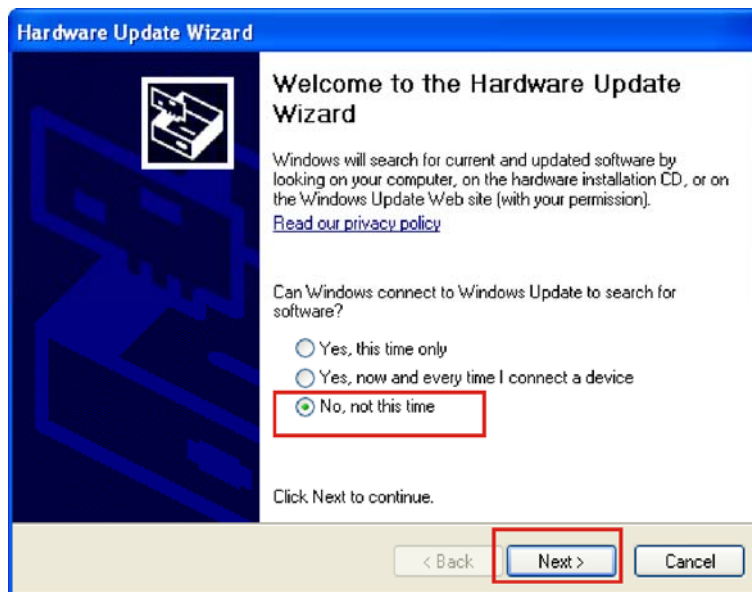

Figure 6-18: Search Windows Update Prompt

Step 6: Select “No, not this time” to force the wizard to search hard drives, CD drives and floppy drives for a driver and not connect to the Internet to search for the appropriate driver (Figure 6-18).

Step 7: The automatic driver search prompt appears (Figure 6-19).

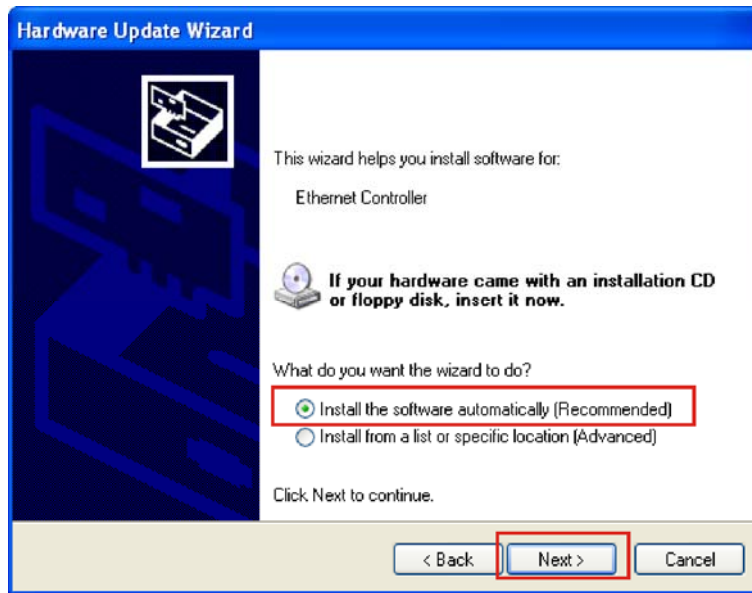

Figure 6-19: Search Windows Update Prompt

Step 8: Select “Install the software automatically (Recommended),” and click **NEXT** to continue (Figure 6-19).

PPC-5xxx-9455 Panel PC

Step 9: After the installation wizard finds the Gigabit Ethernet driver, the **Hardware Update Completed** window appears (Figure 6-20).

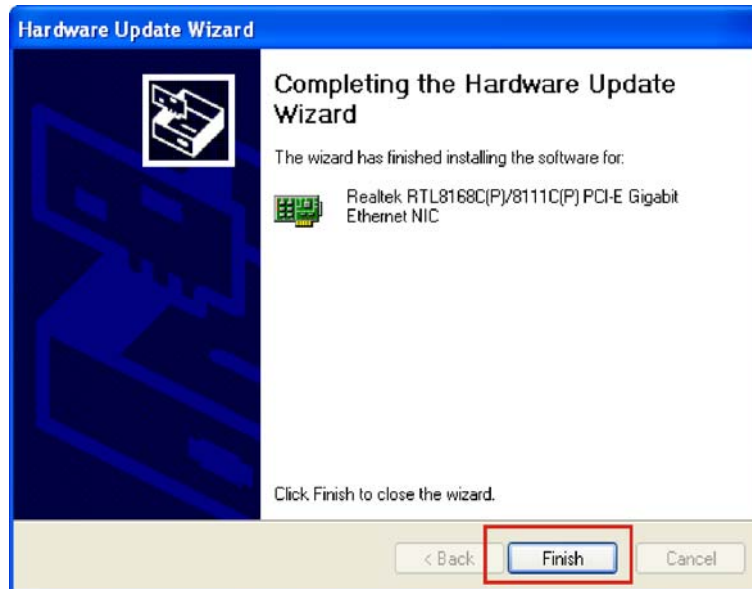

Figure 6-20: Hardware Installation Complete

Step 10: Click **FINISH** to exit the installation wizard and complete the installation process.

6.5 Audio Driver

To install the audio driver, the audio needs to be enabled in the BIOS and then the software driver can be installed.

6.5.1 BIOS Setup

Step 1: Enter the BIOS setup. To do this, reboot the system and press **DEL** during POST.

Step 2: Go to the Southbridge Configuration menu. Set the **Audio Controller** option to [auto].

Step 3: Press **F10** to save the changes and exit the BIOS setup. The system reboots.

6.5.2 Driver Installation

To install the audio driver please follow the steps below.

Step 1: Browse to the **2-Audio\ALC888-5614_PG258_UAAV10a-5013** folder on the installation CD (Figure 6-21).

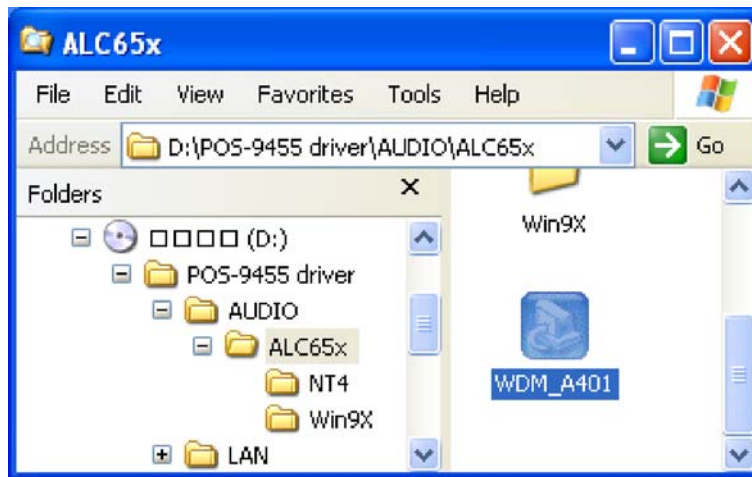

Figure 6-21: Select the Audio Codec

Step 2: Double-click the **Setup** icon.

Step 3: The audio setup window appears (Figure 6-22).

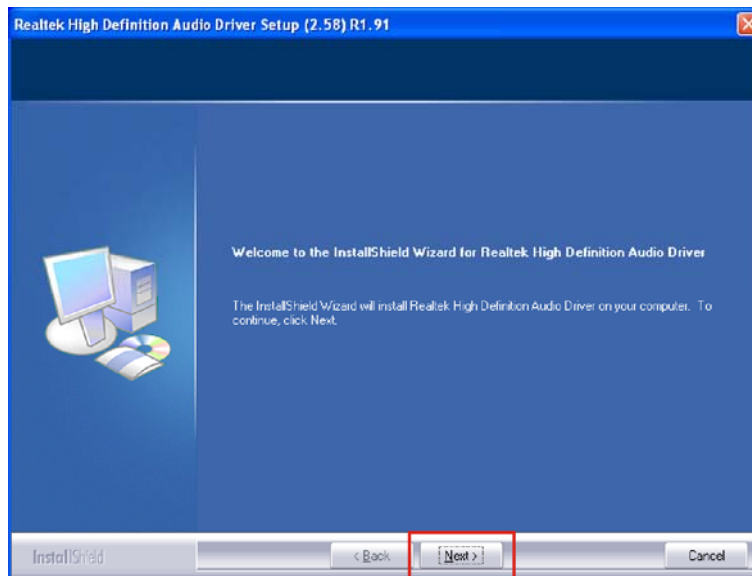

Figure 6-22: Audio Driver Installation

PPC-5xxx-9455 Panel PC

Step 4: Click **NEXT** to start the driver installation (Figure 6-22).

Step 5: The audio driver installation begins.

Step 6: The confirmation screen offers the option of restarting the computer now or later. For the settings to take effect, the computer must be restarted. Click **FINISH** to restart the computer.

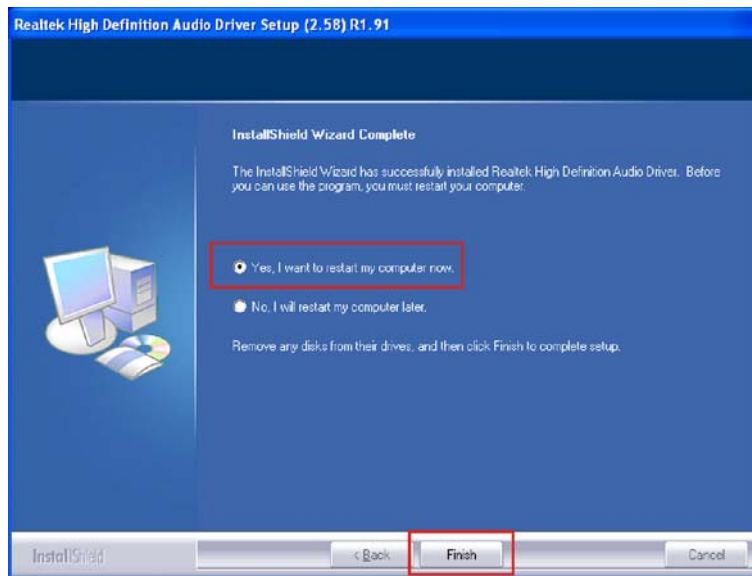

Figure 6-23: InstallShield Wizard Complete

6.6 Touch Panel Driver

To install the touch panel driver, please follow the steps below.

Step 1: Browse to the **Touch** directory on the installation CD (Figure 6-24).

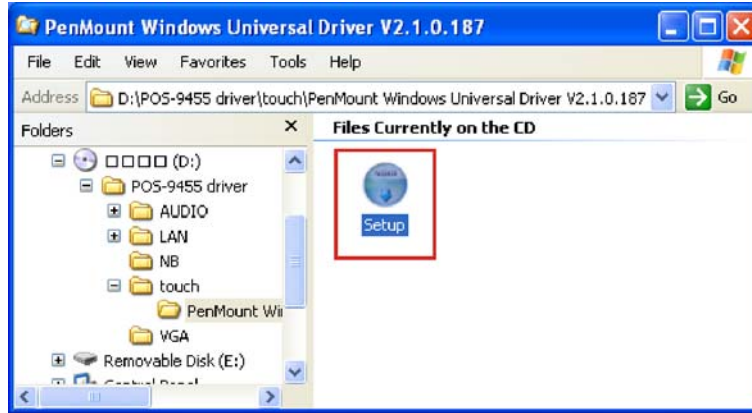

Figure 6-24: S-Video Patch Folder

Step 2: Double-click the **setup** icon (Figure 6-24).

Step 3: A new window opens and the touch panel driver installation wizard is shown (Figure 6-25).

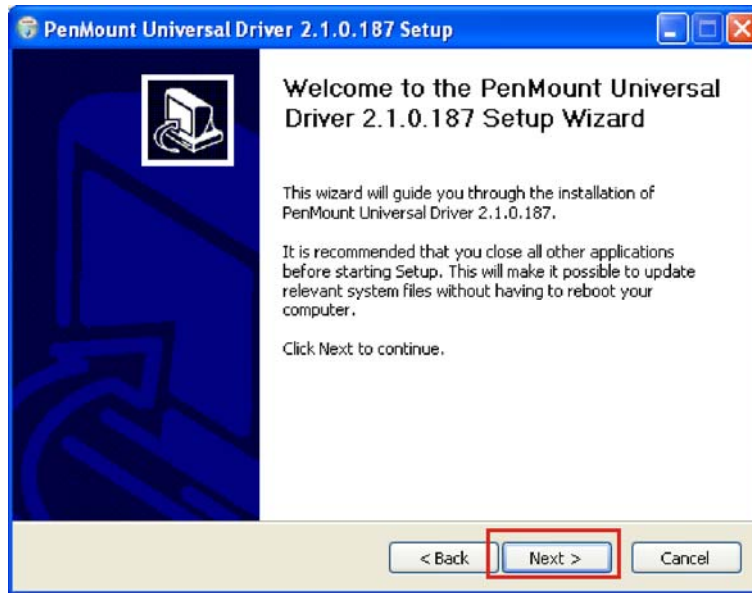

Figure 6-25: Touch Panel Driver Welcome Screen

Step 4: Click **NEXT** to begin the touch panel driver installation process (Figure 6-25).

Step 5: The license agreement window appears (Figure 6-26).

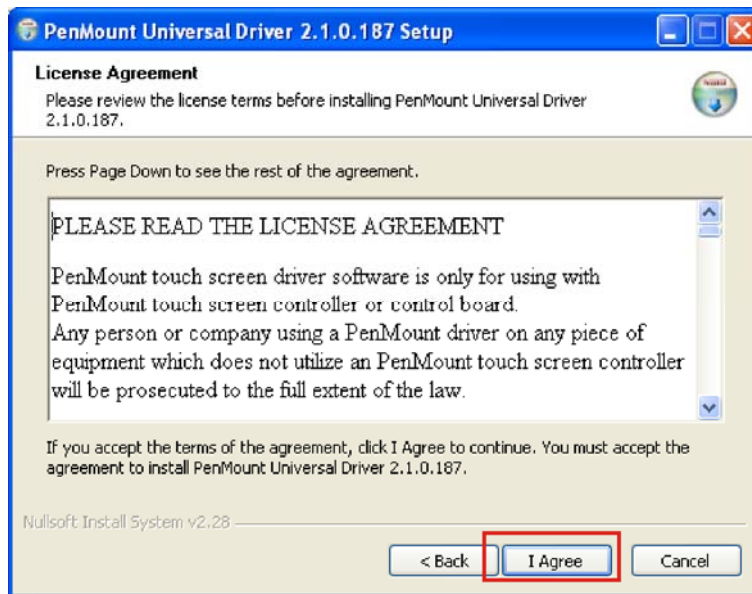

Figure 6-26: Touch Panel License Agreement

Step 6: Read the license agreement carefully. Click **I AGREE** to accept the terms of the agreement and proceed with the installation (Figure 6-26).

Step 7: The **Choose Installation Location** window appears (Figure 6-27).

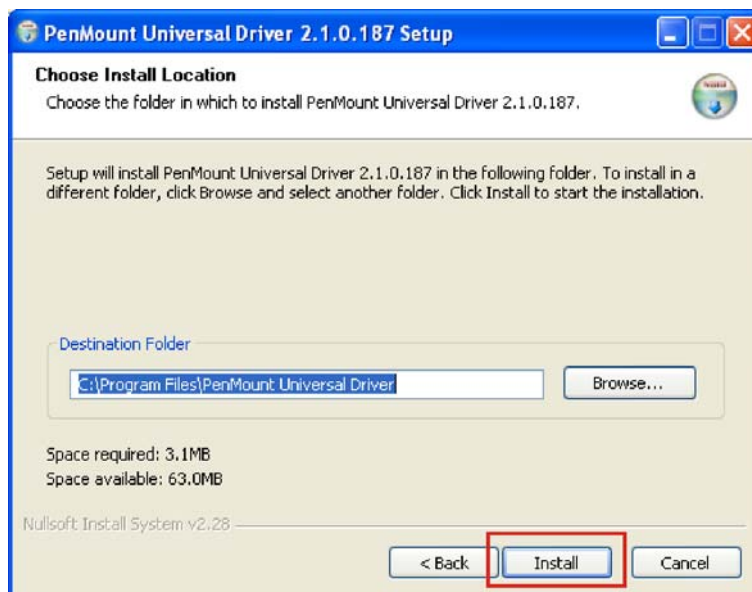

Figure 6-27: Touch Panel Installation Directory

Step 8: Accept the default installation directory (only change if necessary) then click **INSTALL** to install the touch panel drivers (Figure 6-27).

Step 9: The touch panel driver begins installing (Figure 6-28).

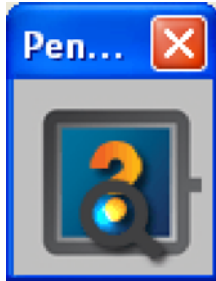

Figure 6-28: Touch Panel Drivers Installing

Step 10: The Windows logo testing warning screen is shown. The warning explains that the software has not passed Windows logo testing. Click **CONTINUE ANYWAY** to continue the installation to continue installing the touch panel driver (Figure 6-29).



Figure 6-29: Windows Logo Testing

Step 11: The InstallShield Wizard Completed window appears (Figure 6-30).

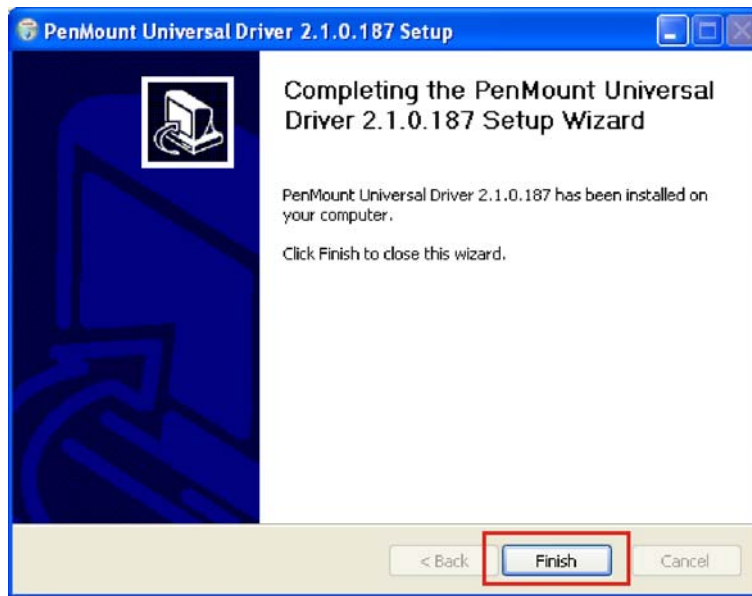

Figure 6-30: InstallShield Wizard Complete

Step 12: Click **FINISH** to complete the installation process and exit the touch panel driver installation program (Figure 6-30).

Chapter

7

System Maintenance

7.1 System Maintenance Introduction

The following system components may require maintenance.

- Motherboard
- DIMM module
- PSU module
- Cooling fans

If these components fail, they must be replaced. Please contact the system reseller or vendor to purchase replacement parts. Replacement instructions for the above listed components are described below.

7.2 Motherboard Replacement

A user cannot replace a motherboard. If the motherboard fails it must be shipped back to IEI to be replaced. If the system motherboard has failed, please contact the system vendor, reseller or an IEI sales person directly.

7.3 Back Cover Removal



WARNING!

Before removing the back cover, make sure all power to the system has been disconnected. Failing to do so may cause severe damage to the PPC-5xxx-9455 and injury to the user.

**WARNING!**

Please take antistatic precautions when working with the internal components. The interior of the PPC-5xxx-9455 contains very sensitive electronic components. These components are easily damaged by electrostatic discharge (ESD). Before working with the internal components, make sure all anti-static precautions described earlier have been observed.

To access the panel PC internal components, the back cover must be removed. To remove the back cover, please follow the steps below.

Please refer to **Section 4.4** for back cover removal instructions.

7.4 DIMM Replacement

Please read the warnings at the beginning of the previous section before attempting to access any PPC-5xxx-9455 internal components.

To install/replace the DIMM modules please follow the steps below.

Step 1: Remove the back cover (**Section 4.4**).

Step 2: Locate the DIMM socket on the motherboard near the right of the chassis. Push down on the white levers of the socket until the DIMM module disengages from the socket (**Figure 7-1**).



Figure 7-1: DIMM Socket Clip Locations

Step 3: Push the new DIMM module until it engages and the white plastic end clips click into place. Make sure the end clips are fully secured after installation.

7.5 Elevated Platform Removal

The elevated platform supports the optical drive and the hard drive. It is not necessary to remove the optical drive bracket or hard drive bracket to remove the elevated platform.

Step 1: Unfasten the elevated platform screws on the top panel (Figure 7-2).



Figure 7-2: Top Panel Elevated Platform Screws

Step 2: Unfasten the elevated platform screws on the side panel (**Figure 7-3**).



Figure 7-3: Side Panel Elevated Platform Screws

Step 3: Unfasten the elevated platform screws on the bottom panel (**Figure 7-4**).



Figure 7-4: Bottom Panel Elevated Platform Screws

PPC-5xxx-9455 Panel PC

Step 4: Unfasten the internal elevated platform screws (**Figure 7-5**).

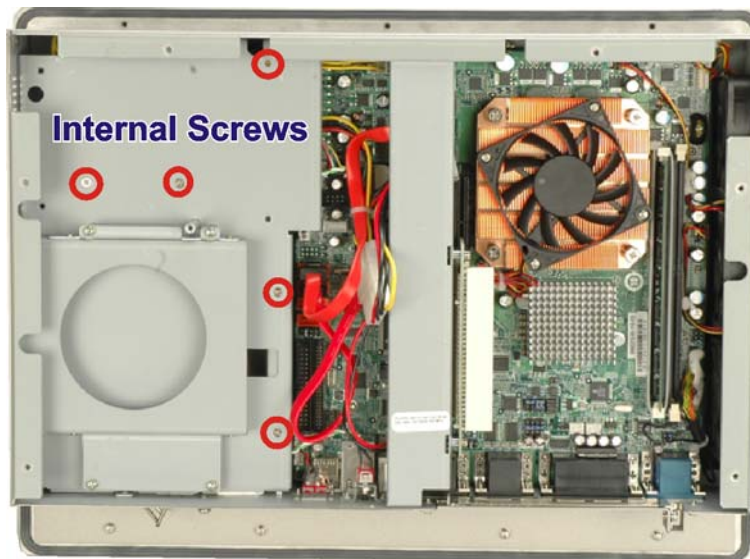

Figure 7-5: Internal Elevated Platform Screws

Step 5: Slide the elevated platform out of the chassis.

7.6 PSU Module Replacement

Please read the warnings at the beginning of **Section 4.3** before attempting to access any PPC-5xxx-9455 internal components.

If the PSU module has been damaged it must be replaced. To replace the PSU module, please follow the steps below.

7.6.1 Remove the Old PSU

Step 1: Remove the back cover (**Section 4.4**).

Step 2: Detach and remove the elevated platform (**Section 7.5**).

Step 3: Disconnect all PSU connections including those to the motherboard (**Figure 7-6**) and any disk drives.



Figure 7-6: PSU Power Cables

Step 4: Unfasten the screws on the inside panel (**Figure 7-7**).



Figure 7-7: PSU Bottom Panel Retention Screws

PPC-5xxx-9455 Panel PC

- Step 5:** Remove the retention screws that connect the PSU bracket to the chassis (Figure 7-8).

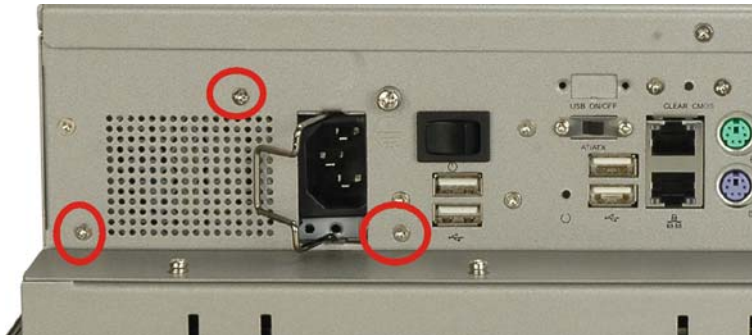

Figure 7-8: PSU Rear Panel Screws

- Step 6:** Remove the retention screws that connect the PSU to the PSU bracket.

7.6.2 Install the New PSU

Installation is done in the reverse order to removal. To install a new PSU module, please follow the steps below.

- Step 1:** Attach the PSU bracket to the PSU module with the previously removed retention screws.
- Step 2:** Insert the PSU module and bracket assembly into the chassis and attach the PSU bracket to the chassis with the previously removed retention screws.
- Step 3:** Secure the PSU module to the chassis by reinserting the previously removed retention screws through the bottom panel.
- Step 4:** Bundle the cables of the new PSU module and secure them with a plastic tie similar to the old PSU module.
- Step 5:** Reconnect all previously disconnected power connectors to the motherboard and disk drives.
- Step 6:** Reattach the elevated platform.
- Step 7:** Replace the back cover.

7.7 System Cooling Fan Replacement

If the system cooling fans have been damaged, they must be replaced. To replace the system cooling fans, please follow the steps below.

7.7.1 Remove the Old System Cooling Fans

- Step 1:** Remove the back cover (Section 4.4).
- Step 2:** Detach and remove the elevated platform (Section 7.5).
- Step 3:** Disconnect the system cooling fans from the motherboard (Figure 7-9).

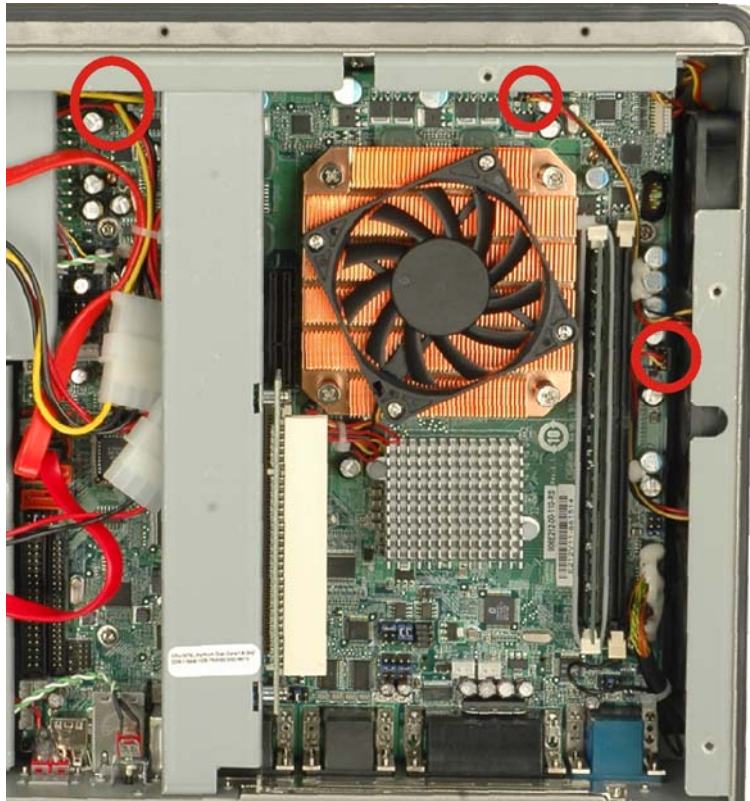

Figure 7-9: System Cooling Fans Motherboard Connector

PPC-5xxx-9455 Panel PC

- Step 4:** Remove the system cooling fans retention screws from the left panel (Figure 7-10).



Figure 7-10: System Cooling Fans Left Panel Retention Screws

- Step 5:** Remove the system cooling fans from the chassis.

7.7.2 Install the New System Cooling Fans

To install the new system cooling fans, please follow the steps below.

- Step 1:** Insert the system cooling fans into the chassis and attach to the left panel with the previously removed retention screws.
- Step 2:** Rebundle the new fan wires and tie them to the chassis like the old fan wires.
- Step 3:** Reconnect the new fan connector to the motherboard.
- Step 4:** Reattach the elevated platform.
- Step 5:** Replace the back cover.



Appendix

A

BIOS Options

PPC-5xxx-9455 Panel PC

Below is a list of BIOS configuration options in the BIOS chapter.

System Overview	72
System Time [xx:xx:xx]	73
System Date [xx/xx/xx]	73
Max CPUID Value Limit [Disabled]	75
Intel® SpeedStep® Technology [Enabled]	76
ATA/IDE Configurations [Enhanced]	77
Configure SATA as [IDE]	78
Configure SATA Channels [IDE]	78
Legacy IDE Channels [PATA Pri, SATA Sec]	78
IDE Master and IDE Slave	78
Auto-Detected Drive Parameters	79
Type [Auto]	80
LBA/Large Mode [Auto]	81
Block (Multi Sector Transfer) [Auto]	81
PIO Mode [Auto]	81
DMA Mode [Auto]	82
S.M.A.R.T [Auto]	83
32Bit Data Transfer [Enabled]	83
Floppy A/B	84
Digital I/O Address [2D8]	85
Serial Port1 Address [3F8/IRQ4]	85
Serial Port1 Mode [Normal]	86
Serial Port2 Address [2F8/IRQ3]	86
Serial Port2 Mode [Normal]	86
Parallel Port Address [Disabled]	87
Parallel Port Mode [Normal]	87
Parallel Port IRQ [IRQ7]	88
Serial Port3 Address [3E8]	88
Serial Port4 Address [2E8]	88
Serial Port5 Address [2F0]	89
Select RS232 or RS422/485 [RS/232]	89
Serial Port6 Address [2D8]	89
CPU FAN 1 Mode Setting [Full On Mode]	91

FAN x Mode Setting [Automatic Mode]	91
Temperature Limit of OFF [025]	91
Temperature Limit of Start [025]	92
Temperature Limit of Full [080]	92
Fan Start PWM [070]	93
Slope PWM [4 PWM]	93
Power Supply Mode [ATX]	95
Suspend Mode [S3(STR)]	96
Power Button Mode [On/Off]	97
Restore on AC Power Loss [Power Off]	97
Resume on Keyboard/Mouse [Disabled]	98
Resume on Ring [Disabled]	98
Resume on PCIE [Enabled]	98
Resume On RTC Alarm [Disabled]	99
Remote Access [Disabled]	100
Serial Port Number [COM1]	101
Base Address, IRQ [3F8h,4]	101
Serial Port Mode [115200 8,n,1]	101
Redirection After BIOS POST [Always]	102
USB Configuration	103
USB Devices Enabled	103
USB Function [Enabled]	103
USB 2.0 Controller [Enabled]	104
Legacy USB Support [Enabled]	104
USB 2.0 Controller Mode [FullSpeed]	104
USB Mass Storage Reset Delay [20 Sec]	105
Device ##	106
Emulation Type [Auto]	106
IRQ# [Available]	108
DMA Channel# [Available]	108
Reserved Memory Size [Disabled]	109
Quick Boot [Enabled]	110
Quiet Boot [Enabled]	110
AddOn ROM Display Mode [Force BIOS]	111
Bootup Num-Lock [On]	111

PPC-5xxx-9455 Panel PC

Boot From LAN Support [Disabled]	111
Change Supervisor Password	116
Change User Password	116
Memory Hole [Disabled]	118
Boot Display Device	119
Flat Panel Type [By Jumper]	119
PID Current Jumper Setting [1-1024x768x24]	119
Internal Graphics Mode Select [Enable, 8 MB]	119
Spectrum [Disabled]	120
Audio Controller [Azalia]	121
Save Changes and Exit	121
Discard Changes and Exit	122
Discard Changes	122
Load Optimal Defaults	122
Load Failsafe Defaults	122

Appendix

B

Terminology

PPC-5xxx-9455 Panel PC

AC '97	Audio Codec 97 (AC'97) refers to a codec standard developed by Intel® in 1997.
ACPI	Advanced Configuration and Power Interface (ACPI) is an OS-directed configuration, power management, and thermal management interface.
AHCI	Advanced Host Controller Interface (AHCI) is a SATA Host controller register-level interface.
ATA	The Advanced Technology Attachment (ATA) interface connects storage devices including hard disks and CD-ROM drives to a computer.
ARMD	An ATAPI Removable Media Device (ARMD) is any ATAPI device that supports removable media, besides CD and DVD drives.
ASKIR	Amplitude Shift Keyed Infrared (ASKIR) is a form of modulation that represents a digital signal by varying the amplitude (“volume”) of the signal. A low amplitude signal represents a binary 0, while a high amplitude signal represents a binary 1.
BIOS	The Basic Input/Output System (BIOS) is firmware that is first run when the computer is turned on and can be configured by the end user
CODEC	The Compressor-Decompressor (CODEC) encodes and decodes digital audio data on the system.
CompactFlash®	CompactFlash® is a solid-state storage device. CompactFlash® devices use flash memory in a standard size enclosure. Type II is thicker than Type I, but a Type II slot can support both types.
CMOS	Complimentary metal-oxide-conductor is an integrated circuit used in chips like static RAM and microprocessors.
COM	COM refers to serial ports. Serial ports offer serial communication to expansion devices. The serial port on a personal computer is usually a male DB-9 connector.
DAC	The Digital-to-Analog Converter (DAC) converts digital signals to analog signals.
DDR	Double Data Rate refers to a data bus transferring data on both the rising and falling edges of the clock signal.

DMA	Direct Memory Access (DMA) enables some peripheral devices to bypass the system processor and communicate directly with the system memory.
DIMM	Dual Inline Memory Modules are a type of RAM that offer a 64-bit data bus and have separate electrical contacts on each side of the module.
DIO	The digital inputs and digital outputs are general control signals that control the on/off circuit of external devices or TTL devices. Data can be read or written to the selected address to enable the DIO functions.
EHCI	The Enhanced Host Controller Interface (EHCI) specification is a register-level interface description for USB 2.0 Host Controllers.
EIDE	Enhanced IDE (EIDE) is a newer IDE interface standard that has data transfer rates between 4.0 MB/s and 16.6 MB/s.
EIST	Enhanced Intel® SpeedStep Technology (EIST) allows users to modify the power consumption levels and processor performance through application software. The application software changes the bus-to-core frequency ratio and the processor core voltage.
FSB	The Front Side Bus (FSB) is the bi-directional communication channel between the processor and the Northbridge chipset.
GbE	Gigabit Ethernet (GbE) is an Ethernet version that transfers data at 1.0 Gb/s and complies with the IEEE 802.3-2005 standard.
GPIO	General purpose input
HDD	Hard disk drive (HDD) is a type of magnetic, non-volatile computer storage device that stores digitally encoded data.
ICH	The Input/Output Control Hub (ICH) is an Intel® Southbridge chipset.
IrDA	Infrared Data Association (IrDA) specify infrared data transmission protocols used to enable electronic devices to wirelessly communicate with each other.
L1 Cache	The Level 1 Cache (L1 Cache) is a small memory cache built into the system processor.
L2 Cache	The Level 2 Cache (L2 Cache) is an external processor memory cache.

PPC-5xxx-9455 Panel PC

LCD	Liquid crystal display (LCD) is a flat, low-power display device that consists of two polarizing plates with a liquid crystal panel in between.
LVDS	Low-voltage differential signaling (LVDS) is a dual-wire, high-speed differential electrical signaling system commonly used to connect LCD displays to a computer.
POST	The Power-on Self Test (POST) is the pre-boot actions the system performs when the system is turned-on.
RAM	Random Access Memory (RAM) is volatile memory that loses data when power is lost. RAM has very fast data transfer rates compared to other storage like hard drives.
SATA	Serial ATA (SATA) is a serial communications bus designed for data transfers between storage devices and the computer chipsets. The SATA bus has transfer speeds up to 1.5 Gb/s and the SATA II bus has data transfer speeds of up to 3.0 Gb/s.
S.M.A.R.T	Self Monitoring Analysis and Reporting Technology (S.M.A.R.T) refers to automatic status checking technology implemented on hard disk drives.
UART	Universal Asynchronous Receiver-transmitter (UART) is responsible for asynchronous communications on the system and manages the system's serial communication (COM) ports.
UHCI	The Universal Host Controller Interface (UHCI) specification is a register-level interface description for USB 1.1 Host Controllers.
USB	The Universal Serial Bus (USB) is an external bus standard for interfacing devices. USB 1.1 supports 12 Mb/s data transfer rates and USB 2.0 supports 480 Mb/s data transfer rates.
VGA	The Video Graphics Array (VGA) is a graphics display system developed by IBM.

Appendix

C

Digital I/O Interface

C.1 Introduction

The DIO connector on the PPC-5xxx-9455 is interfaced to GPIO ports on the Super I/O chipset. The DIO has both 4-bit digital inputs and 4-bit digital outputs. The digital inputs and digital outputs are generally control signals that control the on/off circuit of external devices or TTL devices. Data can be read or written to the selected address to enable the DIO functions.



NOTE:

For further information, please refer to the datasheet for the Super I/O chipset.

C.2 DIO Connector Pinouts

The following table describes how the DIO connector pins are connected to the Super I/O.

Pin	Description	Super I/O Pin	Super I/O Pin No.
1	Ground	N/A	N/A
2	+5 V	N/A	N/A
3	Input 0	GP20	27
4	Output 0	GP14	31
5	Input 1	GP21	26
6	Output 1	GP15	30
7	Input 2	GP22	25
8	Output 2	GP16	29
9	Input 3	GP23	24
10	Output 3	GP17	28

C.3 Assembly Language Samples

C.3.1 Enable the DIO Input Function

The BIOS interrupt call INT 15H controls the digital I/O. An assembly program to enable digital I/O input functions is listed below.

MOV	AX, 6F08H	Sets the digital port as input
INT	15H	Initiates the INT 15H BIOS call

C.3.2 Enable the DIO Output Function

The BIOS interrupt call INT 15H controls the digital I/O. An assembly program to enable digital I/O output functions is listed below.

MOV	AX, 6F09H	Sets the digital port as output
MOV	BL, 09H	
INT	15H	Initiates the INT 15H BIOS call

Appendix

D

Watchdog Timer



NOTE:

The following discussion applies to DOS environment. IEI support is contacted or the IEI website visited for specific drivers for more sophisticated operating systems, e.g., Windows and Linux.

The Watchdog Timer is provided to ensure that standalone systems can always recover from catastrophic conditions that cause the CPU to crash. This condition may have occurred by external EMIs or a software bug. When the CPU stops working correctly, Watchdog Timer either performs a hardware reset (cold boot) or a Non-Maskable Interrupt (NMI) to bring the system back to a known state.

A BIOS function call (INT 15H) is used to control the Watchdog Timer.

INT 15H:

AH – 6FH Sub-function:	
AL – 2:	Sets the Watchdog Timer’s period.
BL:	Time-out value (Its unit-second is dependent on the item “Watchdog Timer unit select” in CMOS setup).

Table D-1: AH-6FH Sub-function

Call sub-function 2 to set the time-out period of Watchdog Timer first. If the time-out value is not zero, the Watchdog Timer starts counting down. When the timer value reaches zero, the system resets. To ensure that this reset condition does not occur, calling sub-function 2 must periodically refresh the Watchdog Timer. However, the watchdog timer is disabled if the time-out value is set to zero.

A tolerance of at least 10% must be maintained to avoid unknown routines within the operating system (DOS), such as disk I/O that can be very time-consuming.



NOTE:

When exiting a program it is necessary to disable the Watchdog Timer, otherwise the system resets.

EXAMPLE PROGRAM:

; INITIAL TIMER PERIOD COUNTER

;

W_LOOP:

;

```

MOV      AX, 6F02H      ;setting the time-out value
MOV      BL, 30         ;time-out value is 48 seconds
INT      15H

```

;

; ADD THE APPLICATION PROGRAM HERE

;

```

CMP      EXIT_AP, 1     ;is the application over?
JNE      W_LOOP        ;No, restart the application

MOV      AX, 6F02H     ;disable Watchdog Timer
MOV      BL, 0         ;
INT      15H

```

;

; EXIT ;

Appendix

E

Address Mapping

E.1 Direct Memory Access (DMA)

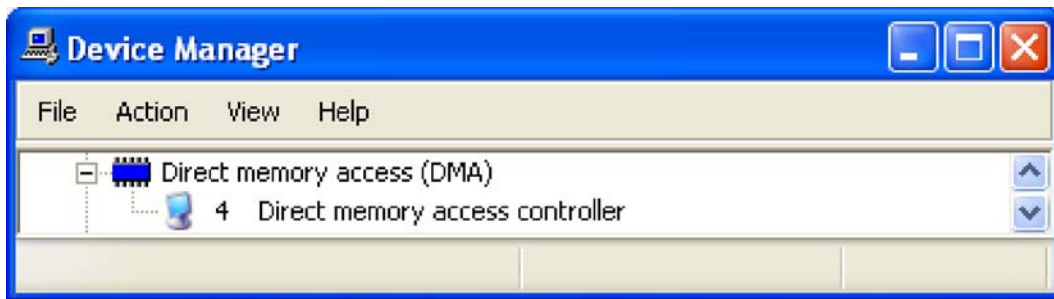

Figure E-1: Direct Memory Access (DMA)

E.2 Input/Output (IO)

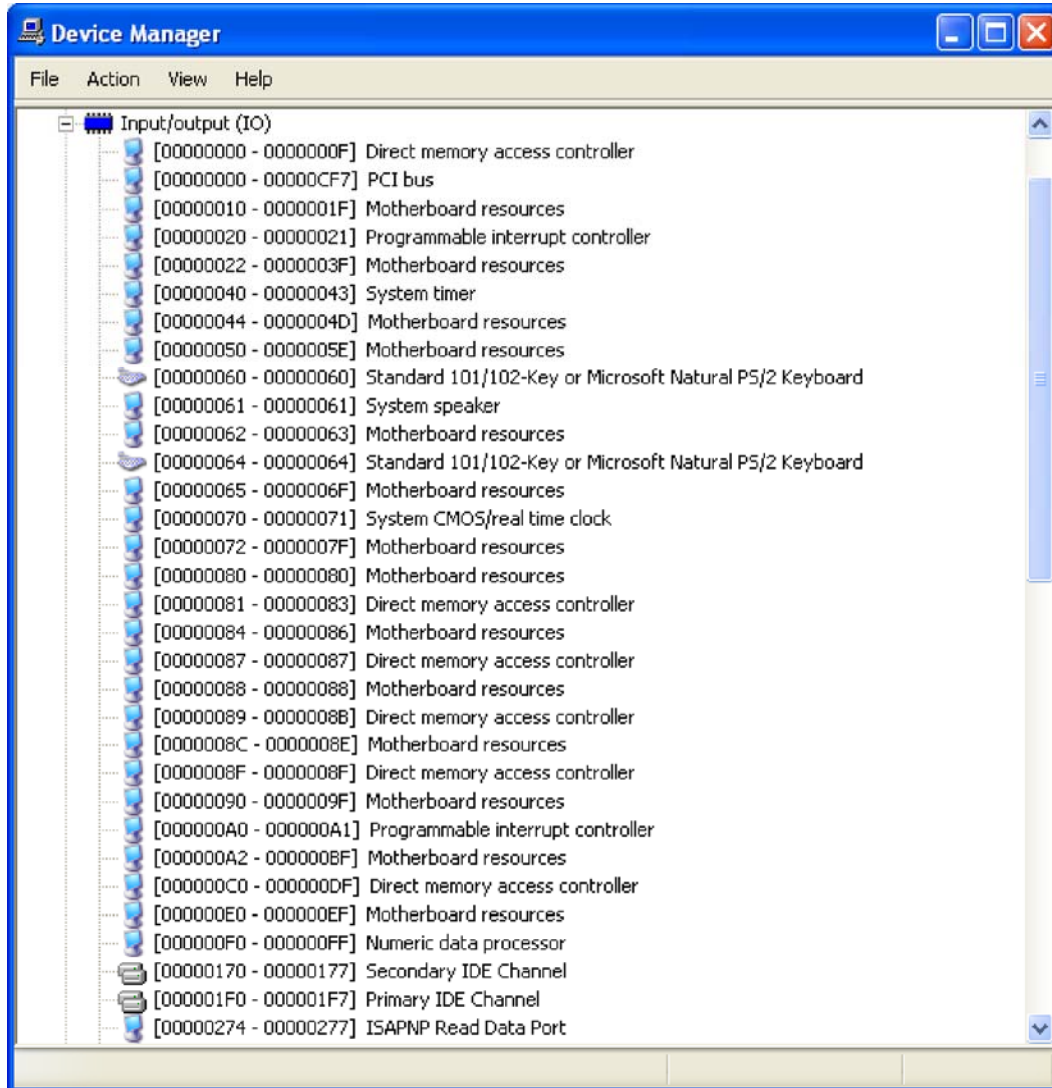

Figure E-2: Input/Output (IO) (1 of 2)

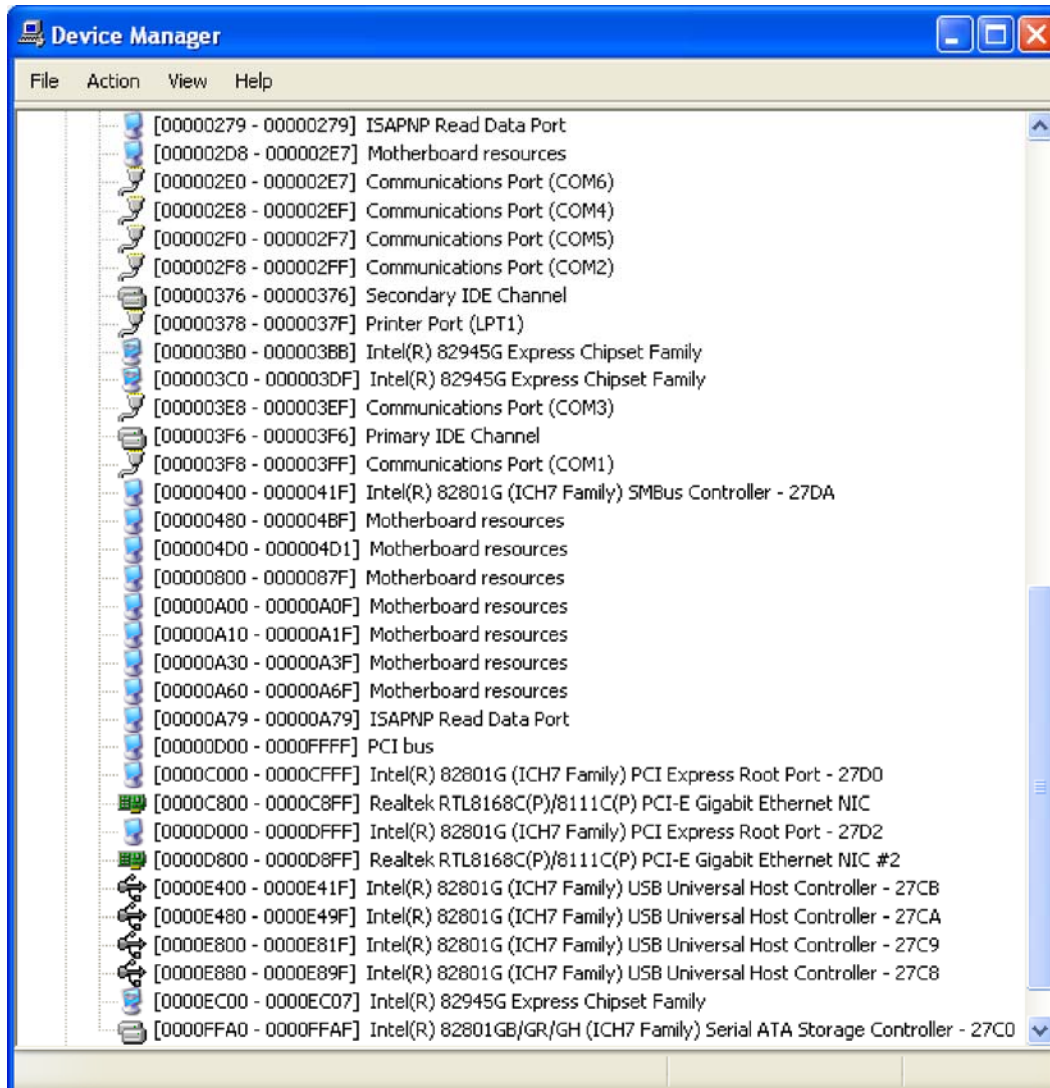

Figure E-3: Input/Output (IO) (2 of 2)

E.3 Interrupt Request (IRQ)

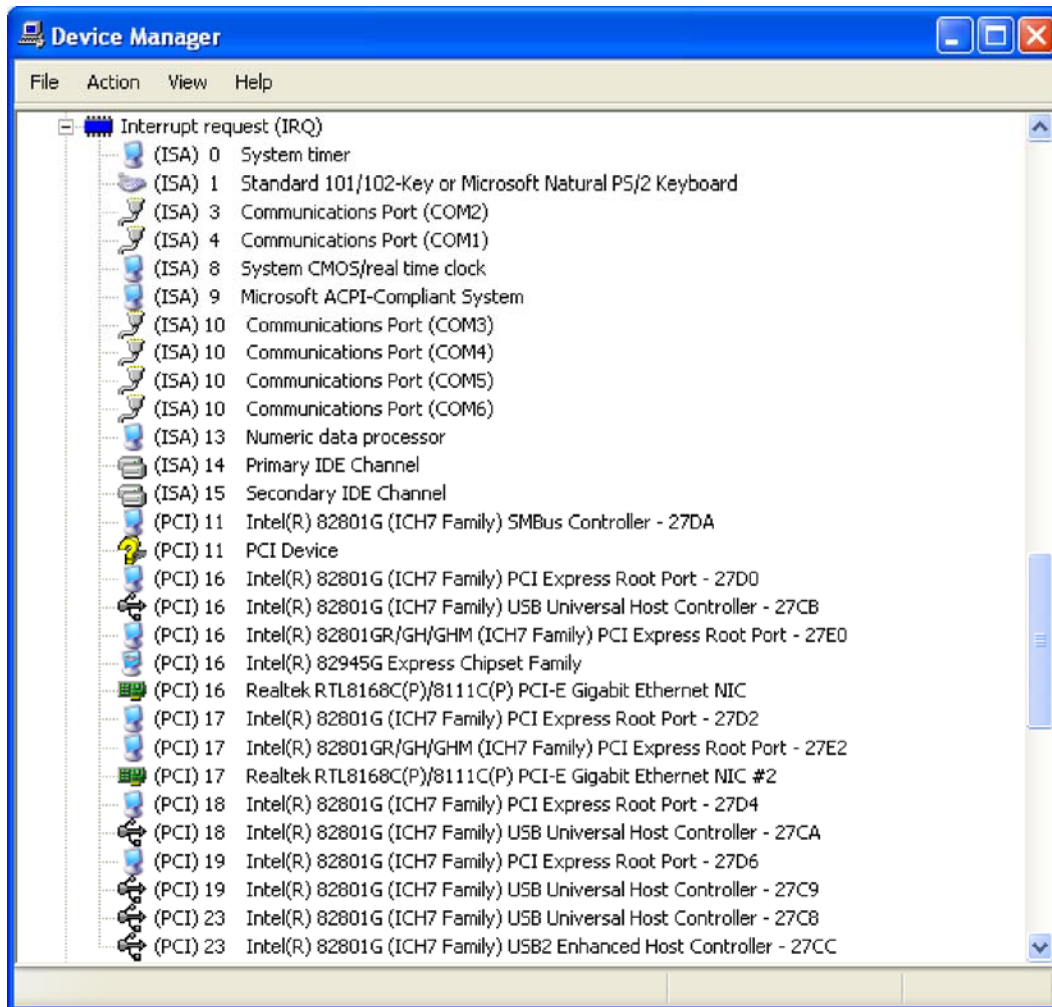

Figure E-4: Interrupt Request (IRQ)

E.4 Memory

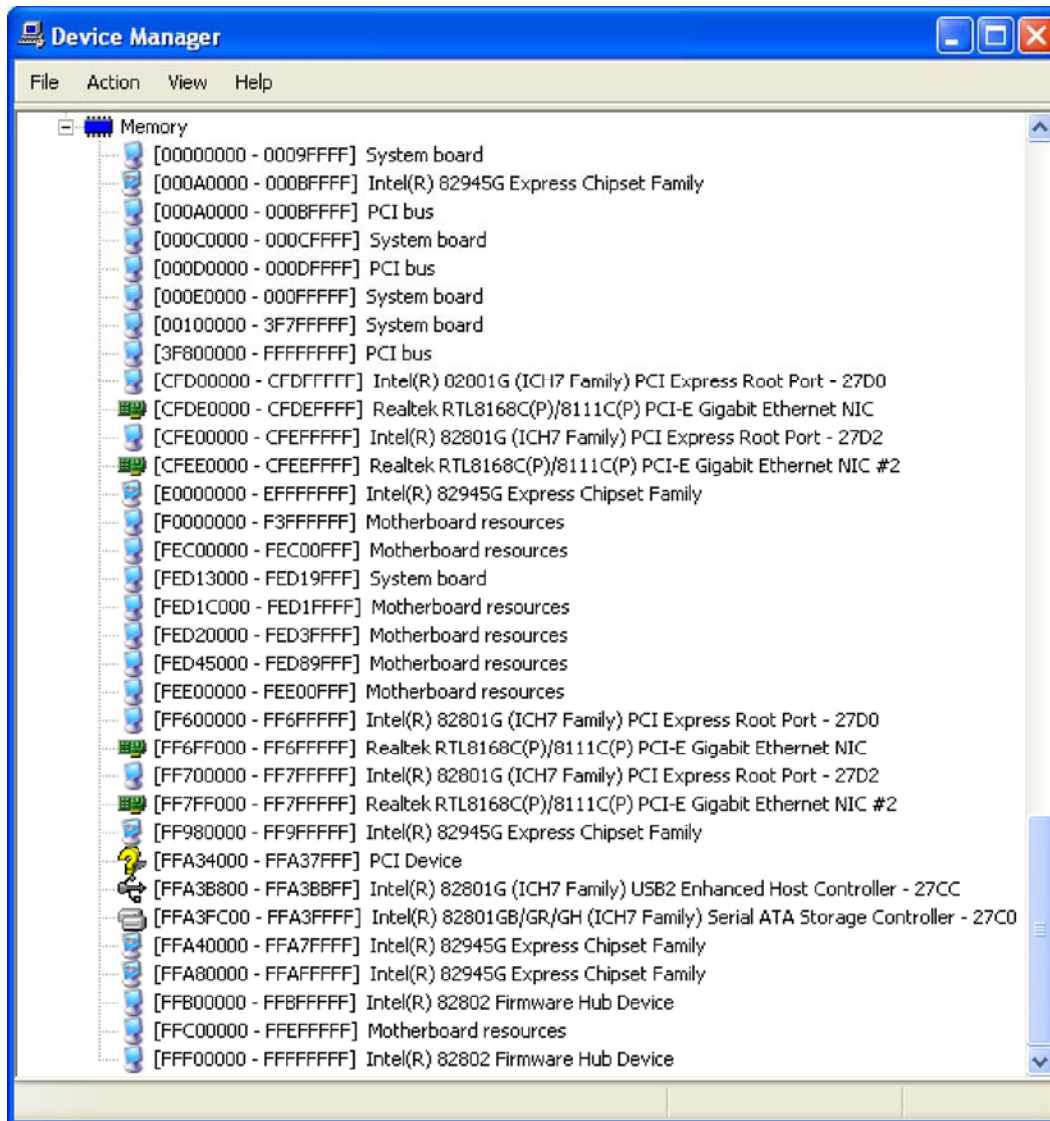

Figure E-5: Memory



Appendix

F

Compatibility

**NOTE:**

The compatible items described here have been tested by the IEI R&D team and found to be compatible with the PPC-5xxx-9455

F.1 Compatible Operating Systems

The following operating systems have been successfully run on the PPC-5xxx-9455.

- MS-DOS 6.22
- Microsoft Windows XP (32-bit)
- Microsoft Windows 2000
- Red Hat 9.0

F.2 Compatible Processors

The following LGA775 processors have been successfully tested on the PPC-5xxx-9455

CPU	FSB	Frequency	L2 Cache
Intel® Pentium 4	800 MHz	3.4 GHz	1 MB

F.3 Compatible Memory Modules

**NOTE:**

The memory modules listed below have been tested on the PPC-5xxx-9455 other memory modules that comply with the specifications may also work on the PPC-5xxx-9455 but have not been tested.

The following memory modules have been successfully tested on the PPC-5xxx-9455.

Manufacturer	Model	Capacity	Speed	Type
Transcend	507303-0233	1.0 GB	667 MHz	DDR2

Appendix

G

Hazardous Materials Disclosure

G.1 Hazardous Materials Disclosure Table for IPB Products Certified as RoHS Compliant Under 2002/95/EC Without Mercury

The details provided in this appendix are to ensure that the product is compliant with the Peoples Republic of China (China) RoHS standards. The table below acknowledges the presences of small quantities of certain materials in the product, and is applicable to China RoHS only.

A label will be placed on each product to indicate the estimated “Environmentally Friendly Use Period” (EFUP). This is an estimate of the number of years that these substances would “not leak out or undergo abrupt change.” This product may contain replaceable sub-assemblies/components which have a shorter EFUP such as batteries and lamps. These components will be separately marked.

Please refer to the table on the next page.

PPC-5xxx-9455 Panel PC

Part Name	Toxic or Hazardous Substances and Elements					
	Lead (Pb)	Mercury (Hg)	Cadmium (Cd)	Hexavalent Chromium (CR(VI))	Polybrominated Biphenyls (PBB)	Polybrominated Diphenyl Ethers (PBDE)
Housing	X	O	O	O	O	X
Display	X	O	O	O	O	X
Printed Circuit Board	X	O	O	O	O	X
Metal Fasteners	X	O	O	O	O	O
Cable Assembly	X	O	O	O	O	X
Fan Assembly	X	O	O	O	O	X
Power Supply Assemblies	X	O	O	O	O	X
Battery	O	O	O	O	O	O

O: This toxic or hazardous substance is contained in all of the homogeneous materials for the part is below the limit requirement in SJ/T11363-2006

X: This toxic or hazardous substance is contained in at least one of the homogeneous materials for this part is above the limit requirement in SJ/T11363-2006

此附件旨在确保本产品符合中国 RoHS 标准。以下表格标示此产品中某有毒物质的含量符合中国 RoHS 标准规定的限量要求。

本产品上会附有“环境友好使用期限”的标签，此期限是估算这些物质“不会有泄漏或突变”的年限。本产品可能包含有较短的环境友好使用期限的可替换元件，像是电池或灯管，这些元件将会单独标示出来。

部件名称	有毒有害物质或元素					
	铅 (Pb)	汞 (Hg)	镉 (Cd)	六价铬 (CR(VI))	多溴联苯 (PBB)	多溴二苯 醚 (PBDE)
壳体	X	O	O	O	O	X
显示	X	O	O	O	O	X
印刷电路板	X	O	O	O	O	X
金属螺帽	X	O	O	O	O	O
电缆组装	X	O	O	O	O	X
风扇组装	X	O	O	O	O	X
电力供应组装	X	O	O	O	O	X
电池	O	O	O	O	O	O

O: 表示该有毒有害物质在该部件所有物质材料中的含量均在 SJ/T11363-2006 标准规定的限量要求以下。
X: 表示该有毒有害物质至少在该部件的某一均质材料中的含量超出 SJ/T11363-2006 标准规定的限量要求。