

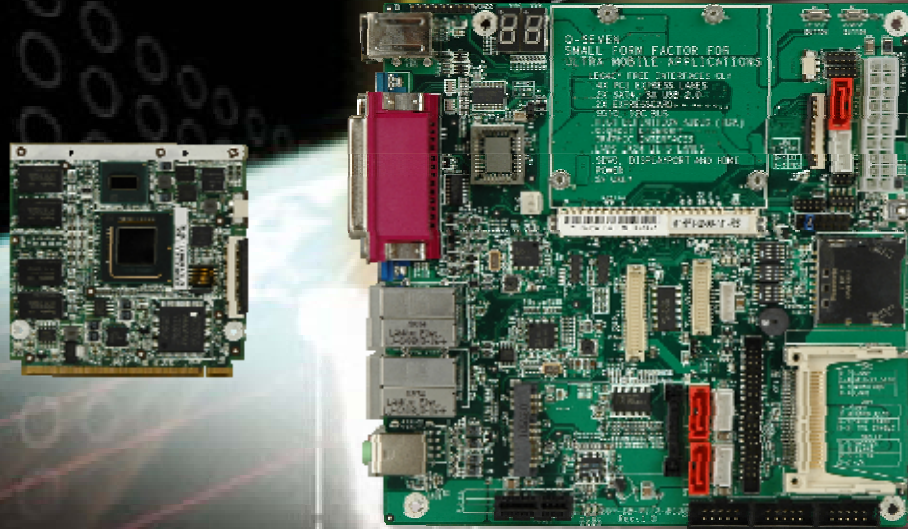

IEI Technology Corp.



IQ7 Design Guide

IQ7 Design Guide for IQ7-US15W and IQ7-DB-MITX

User Manual

Rev. 1.01 – 22 July, 2009



Revision

Date	Version	Changes
22 July, 2009	1.01	Various updates and changes
19 May, 2009	1.00	Initial release

Copyright

COPYRIGHT NOTICE

The information in this document is subject to change without prior notice in order to improve reliability, design and function and does not represent a commitment on the part of the manufacturer.

In no event will the manufacturer be liable for direct, indirect, special, incidental, or consequential damages arising out of the use or inability to use the product or documentation, even if advised of the possibility of such damages.

This document contains proprietary information protected by copyright. All rights are reserved. No part of this manual may be reproduced by any mechanical, electronic, or other means in any form without prior written permission of the manufacturer.

TRADEMARKS

All registered trademarks and product names mentioned herein are used for identification purposes only and may be trademarks and/or registered trademarks of their respective owners.

Table of Contents

1 IQ7-US15W INTRODUCTION.....	1
1.1 IQ7-US15W	2
1.2 BENEFITS	2
1.3 FEATURES.....	3
1.4 CONNECTORS	3
1.5 DIMENSIONS.....	3
1.6 DATA FLOW	5
1.7 TECHNICAL SPECIFICATIONS	5
2 IQ7-US15W CONNECTOR PINOUTS.....	7
2.1 PERIPHERAL INTERFACE CONNECTORS.....	8
2.2 LAYOUT.....	8
2.3 CONNECTOR PINOUTS	8
2.3.1 <i>QSeven Connector</i>	9
2.3.2 <i>IDE Connector</i>	13
3 IQ7-DB-MITX INTRODUCTION.....	16
3.1 INTRODUCTION.....	17
3.2 BENEFITS	17
3.3 FEATURES.....	18
3.4 CONNECTORS	19
3.5 DIMENSIONS.....	20
3.6 DATA FLOW	23
3.7 TECHNICAL SPECIFICATIONS	24
4 IQ7-DB-MITX CONNECTOR PINOUTS	26
4.1 PERIPHERAL INTERFACE CONNECTORS.....	27
4.1.1 <i>Layout</i>	27
4.1.2 <i>Peripheral Interface Connectors</i>	28
4.1.3 <i>External Interface Panel Connectors</i>	29
4.2 INTERNAL PERIPHERAL CONNECTORS	29

IQ7 Design Guide

4.2.1 ATX Power Connector	29
4.2.2 Backlight Inverter Connector	30
4.2.3 CompactFlash® Slot.....	31
4.2.4 Digital I/O Connector.....	32
4.2.5 Fan Connector	33
4.2.6 Front Panel Connector	34
4.2.7 IDE Connector.....	35
4.2.8 IDE (CPU Module to Baseboard).....	37
4.2.9 LVDS Connector	38
4.2.10 Mini USB Port.....	39
4.2.11 PCI Express x1 Slot.....	40
4.2.12 PCIe Mini Card Slot	41
4.2.13 Power Button	43
4.2.14 QSeven Connector	43
4.2.15 Reset Button	48
4.2.16 SATA Drive Connectors	48
4.2.17 SATA Power Connectors	49
4.2.18 SDVO Connector.....	50
4.2.19 Serial Port Connectors	51
4.2.20 TTL Connector	52
4.2.21 USB Connector	53
4.3 EXTERNAL INTERFACE CONNECTORS	55
4.3.1 Audio Connector	55
4.3.2 Ethernet Connector.....	56
4.3.3 Keyboard and Mouse Connector	57
4.3.4 Parallel Port Connector	58
4.3.5 Serial Port Connector.....	59
4.3.6 USB Ports.....	60
4.3.7 VGA Connector	61
4.4 JUMPER SETTINGS	62
4.4.1 AT/ATX Mode Selection	63
4.4.2 Clear CMOS Jumper.....	64
4.4.3 CompactFlash® Master/Slave Selection	65
4.4.4 CompactFlash® Voltage Selection	65
4.4.5 LAN & PCIe Enable/Disable.....	65

4.4.6 TTL Voltage Selection	66
4.4.7 SATA & Graphics Settings	66
4.4.8 TTL Enabled/Disable	67
5 INSTALLATION	68
5.1 ANTI-STATIC PRECAUTIONS	69
5.2 INSTALLATION CONSIDERATIONS.....	69
5.3 CPU MODULE INSTALLATION	71
6 BIOS.....	73
6.1 INTRODUCTION.....	74
6.1.1 Starting Setup.....	74
6.1.2 Using Setup	74
6.1.3 Getting Help.....	75
6.1.4 Unable to Reboot After Configuration Changes.....	75
6.1.5 BIOS Menu Bar.....	75
6.2 MAIN.....	76
6.3 ADVANCED.....	77
6.3.1 CPU Configuration.....	78
6.3.2 IDE Configuration	79
6.3.2.1 IDE Master, IDE Slave	80
6.3.3 Super IO Configuration	84
6.3.4 Hardware Health Configuration.....	88
6.3.5 AHCI Configuration.....	91
6.3.5.1 AHCI Port n	92
6.3.6 Intel AMT Configuration.....	93
6.3.6.1 ME Subsystem Configuration.....	94
6.3.7 Remote Access Configuration	96
6.3.8 USB Configuration.....	98
6.3.8.1 USB Mass Storage Device Configuration.....	101
6.4 PCI/PNP.....	103
6.5 BOOT.....	104
6.5.1 Boot Settings Configuration.....	105
6.5.2 Boot Device Priority	107
6.5.3 Hard Disk Drives	108

IQ7 Design Guide

6.5.4 Removable Drives	108
6.5.5 CD/DVD Drives	109
6.6 SECURITY	109
6.7 CHIPSET	111
6.7.1 Northbridge Configuration	111
6.7.2 Southbridge Configuration	113
6.8 EXIT	114
A BIOS OPTIONS	116
B TERMINOLOGY	120
C HAZARDOUS MATERIALS DISCLOSURE	124
C.1 HAZARDOUS MATERIALS DISCLOSURE TABLE FOR IPB PRODUCTS CERTIFIED AS ROHS COMPLIANT UNDER 2002/95/EC WITHOUT MERCURY	125

List of Figures

Figure 1-1: IQ7-US15W IQ7 Design Guide.....	2
Figure 1-2: Connectors	3
Figure 1-3: IQ7-US15W Dimensions (mm)	4
Figure 1-4: Data Flow Diagram.....	5
Figure 2-1: Connector and Jumper Locations.....	8
Figure 2-2: QSeven Connector.....	9
Figure 2-3: IDE Connector	14
Figure 3-1: IQ7-DB-MITX	17
Figure 3-2: Top Connectors.....	19
Figure 3-3: Rear Panel Connectors.....	20
Figure 3-4: IQ7-DB-MITX Dimensions (mm).....	21
Figure 3-5: External Interface Panel Dimensions (mm).....	22
Figure 3-6: Data Flow Diagram.....	23
Figure 4-1: Connector and Jumper Locations.....	27
Figure 4-2: ATX Power Connector Pinout Locations.....	30
Figure 4-3: Backlight Inverter Connector.....	31
Figure 4-4: CompactFlash® Slot Location.....	32
Figure 4-5: Digital I/O Connector Locations	33
Figure 4-6: Fan Connector Location.....	34
Figure 4-7: Front Panel Connector Pinout Locations	35
Figure 4-8: IDE Connector Locations	36
Figure 4-9: CPU Module to Baseboard IDE Connector Location.....	37
Figure 4-10: LVDS Connector Location.....	38
Figure 4-11: Mini USB Port Location	40
Figure 4-12: PCIe x1 Connector Location	41
Figure 4-13: PCIe Mini Card Slot Location.....	42
Figure 4-14: Power Button Location.....	43
Figure 4-15: QSeven Connector Location.....	44
Figure 4-16: Reset Button Location.....	48
Figure 4-17: SATA Drive Connector Locations	49

IQ7 Design Guide

Figure 4-18: SATA Power Connector Locations	49
Figure 4-19: Serial Port Connector Locations	51
Figure 4-20: TTL Connector Location.....	52
Figure 4-21: USB Connector Locations.....	54
Figure 4-22: External Interface Connectors.....	55
Figure 4-23: Audio Connector	56
Figure 4-24: Ethernet Connector.....	57
Figure 4-25: PS/2 Connector	58
Figure 4-26: Parallel Port Connector Location	59
Figure 4-27: Serial Port Pinout Locations	60
Figure 4-28: VGA Connector	61
Figure 4-29: Jumpers	63
Figure 5-1: Installing the QSeven CPU Module	72

List of Tables

Table 1-1: Technical Specifications	6
Table 2-1: Peripheral Interface Connectors	8
Table 2-2: QSeven Connector	13
Table 2-3: IDE Connector	15
Table 3-1: Technical Specifications	25
Table 4-1: Peripheral Interface Connectors	28
Table 4-2: Rear Panel Connectors	29
Table 4-3: ATX Power Connector Pinouts	30
Table 4-4: Backlight Inverter Connector	31
Table 4-5: Digital I/O Connector Pinouts	33
Table 4-6: Fan Connector Pinouts	34
Table 4-7: Front Panel Connector Pinouts	35
Table 4-8: IDE Connector Pinouts	37
Table 4-9: CPU Module to Baseboard IDE Pinouts	38
Table 4-10: LVDS Connector Pinouts	39
Table 4-11: Mini USB Port Pinouts	40
Table 4-12: PCIe x1 Slot Pinouts	41
Table 4-13: PCIe Mini Card Slot Pinouts	43
Table 4-14: QSeven Connector Pinouts	48
Table 4-15: SATA Power Connector Pinouts	50
Table 4-16: IDE Connector Pinouts	51
Table 4-17: Serial Port Connector Pinouts	52
Table 4-18: TTL Connector Pinouts	53
Table 4-19: USB Port Connector Pinouts	54
Table 4-20: Audio Connector Pinouts	56
Table 4-21: Ethernet Connector Pinouts	56
Table 4-22: Connector LEDs	57
Table 4-23: PS/2 Connectors	58
Table 4-24: Parallel Port Connector Pinouts	59
Table 4-25: Serial Port Pinouts	60

IQ7 Design Guide

Table 4-26: USB Connector Pinouts	61
Table 4-27: VGA Connector Pinouts	61
Table 4-28: Jumpers	62
Table 4-29: AT/ATX Mode Selection	63
Table 4-30: AT/ATX Mode Selection	64
Table 4-31: Clear CMOS Jumper Settings.....	64
Table 4-32: CompactFlash® Master/Slave Selection	65
Table 4-33: CompactFlash® Voltage Selection	65
Table 4-34: LAN & PCIe Enable/Disable	66
Table 4-35: LVDS Voltage Selection	66
Table 4-36: LAN & PCIe Enable/Disable	67
Table 4-37: TTL Enable/Disable.....	67
Table 6-1: BIOS Navigation Keys	75

BIOS Menus

BIOS Menu 1: Main	76
BIOS Menu 2: Advanced	77
BIOS Menu 3: CPU Configuration	78
BIOS Menu 4: IDE Configuration	79
BIOS Menu 5: IDE Master and IDE Slave Configuration	80
BIOS Menu 6: Super IO Configuration	84
BIOS Menu 7: Hardware Health Configuration	88
BIOS Menu 8: AHCI Configuration	91
BIOS Menu 9: AHCI Port n Configuration Menu	92
BIOS Menu 10: Intel AMT Configuration	93
BIOS Menu 11: ME Subsystem Configuration	94
BIOS Menu 12: Remote Access Configuration	96
BIOS Menu 13: USB Configuration	98
BIOS Menu 14: USB Mass Storage Device Configuration	101
BIOS Menu 15: PCI/PnP Configuration	103
BIOS Menu 16: Boot	104
BIOS Menu 17: Boot Settings Configuration	105
BIOS Menu 18: Boot Device Priority Settings	107
BIOS Menu 19: Hard Disk Drives	108
BIOS Menu 20: Removable Drives	108
BIOS Menu 21: CD/DVD Drives	109
BIOS Menu 22: Security	109
BIOS Menu 23: Chipset	111
BIOS Menu 24: Northbridge Chipset Configuration	111
BIOS Menu 25: Southbridge Chipset Configuration	113
BIOS Menu 26: Exit	114

Chapter

1

IQ7-US15W Introduction

1.1 IQ7-US15W

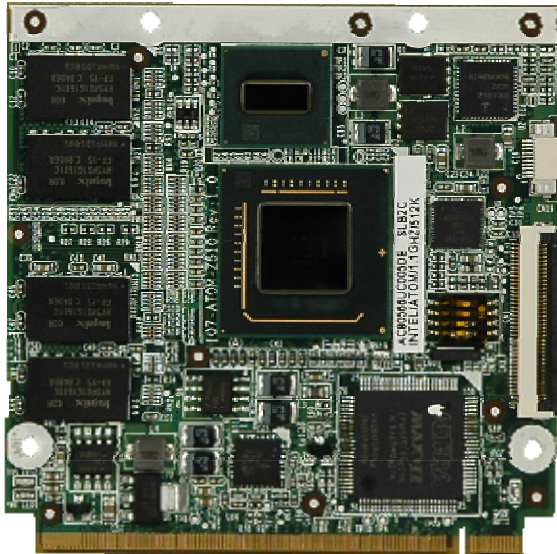

Figure 1-1: IQ7-US15W IQ7 Design Guide

The IQ7-US15W is a QSeven CPU Module with a 1.1 GHz Intel® Atom™ Z510 or 1.6 GHz Intel® Atom™ Z530 CPU.

The IQ7-US15W is designed for applications that require fanless operation. The low power CPUs don't require active cooling and stay within specified heat range using the included cooling solution.

As part of the QSeven standard, an API software interface is defined for the embedded features such as a watchdog timer, I²C bus, LCD backlight control, BIOS user storage area and temperature control.

Graphics capabilities include SDVO and 18/24-bit LVDS to the baseboard.

Other interfaces include IDE, USB and HD Audio.

1.2 Benefits

Some of the IQ7-US15W motherboard benefits include,

- Low power consumption
- Wide range of I/O interfaces

IQ7 Design Guide

- Standard API software interface for embedded features

1.3 Features

Some of the IQ7-US15W motherboard features are listed below:

- QSeven form factor
- RoHS compliant
- PCIe x1 expansion
- Includes 1.0 GB DDR2

1.4 Connectors

The connectors on the IQ7-US15W are shown in the figure below.

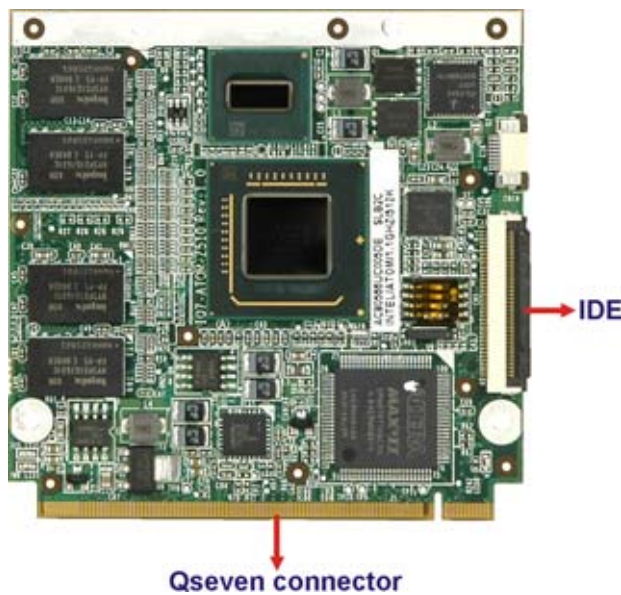

Figure 1-2: Connectors

1.5 Dimensions

The main dimensions of the IQ7-US15W are shown in the diagram below.

- Length: 70 mm
- Width: 70 mm

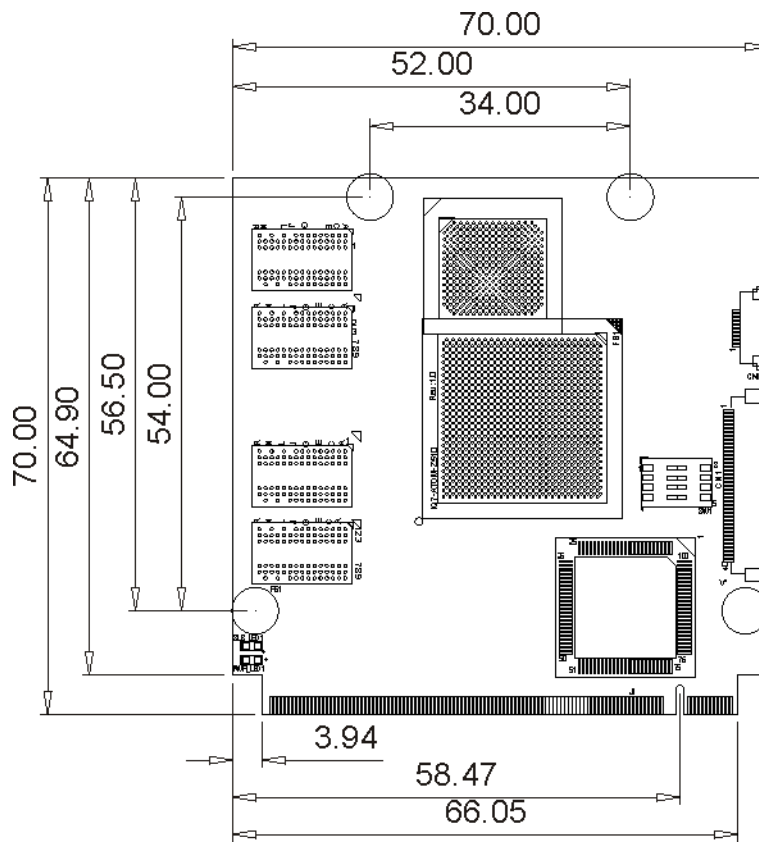

Figure 1-3: IQ7-US15W Dimensions (mm)

IQ7 Design Guide

1.6 Data Flow

Figure 1-4 shows the data flow between the system chipset, the CPU and other components installed on the motherboard.

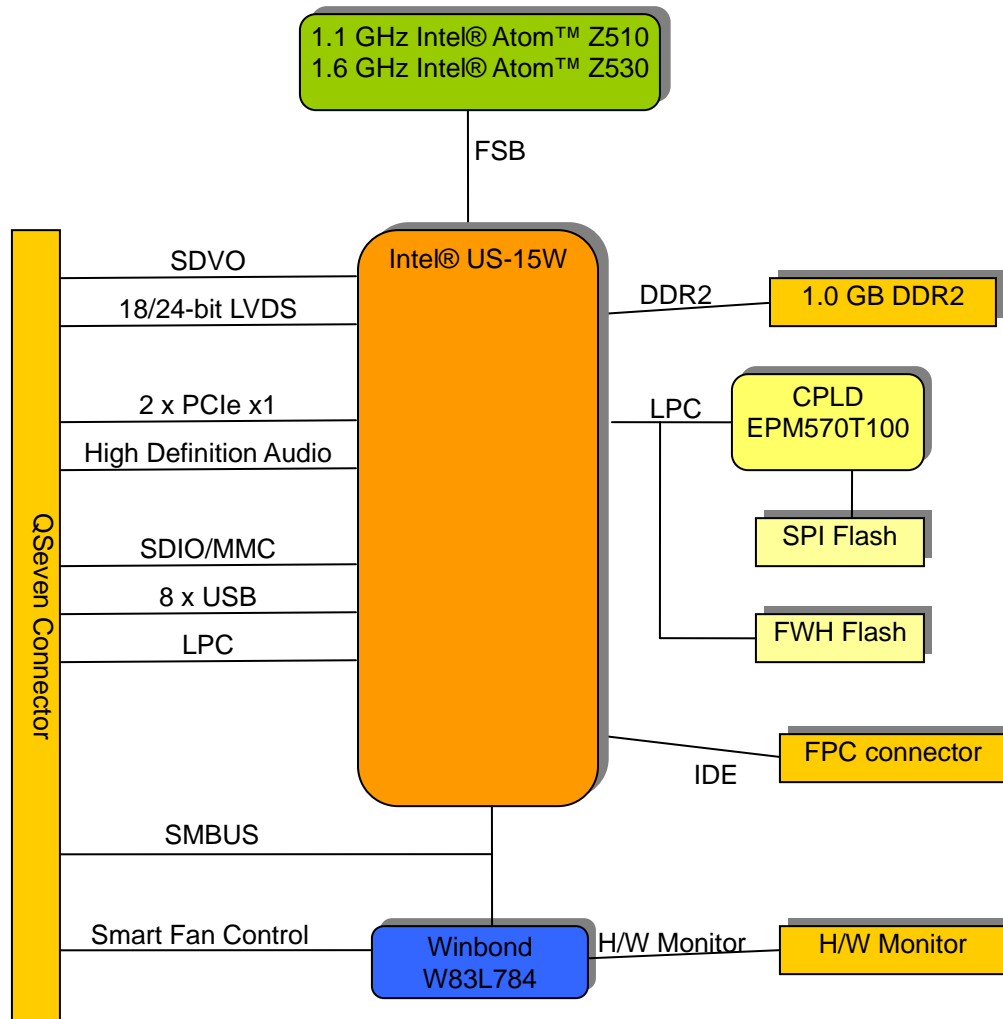

Figure 1-4: Data Flow Diagram

1.7 Technical Specifications

IQ7-US15W technical specifications are listed in Table 1-1.

Specification	IQ7-US15W
Form Factor	QSeven

Specification	IQ7-US15W
Socket	Embedded
CPU Supported	1.1 GHz Intel® Atom™ Z510, 1.6 GHz Intel® Atom™ Z530
Front Side Bus (FSB)	400 MHz, 533 MHz
System Chipset	Intel® US-15W
Memory	1.0 GB DDR2
Audio	HD audio connection to baseboard
BIOS	FWH BIOS
Expansion	
PCIe	2 x PCIe x1 to baseboard
I/O Interface Connectors	
Display port	SDVO to baseboard 24-bit LVDS to baseboard
USB	8 x USB to baseboard
Storage	
Serial ATA	2 x SATA to baseboard
Environmental and Power Specifications	
Power Supply	5 V AT/ATX supported
Power Consumption	1.255 A @ 5 V (1.1 GHz Intel® Atom™ Z510, 1 GB DDR2) 1.34 A @ 5 V (1.6 GHz Intel® Atom™ Z530, 1 GB DDR2)
Operating temperature	0°C ~ 60°C (requires cooler and silicone heat sink paste)
Humidity	0% ~ 95% (non-condensing)
Physical Specifications	
Dimensions	70 mm x 70 mm
Weight GW/NW	600 g/100 g

Table 1-1: Technical Specifications

Chapter

2

IQ7-US15W Connector Pinouts

2.1 Peripheral Interface Connectors

This chapter gives an overview of all the connectors on the IQ7-US15W and their pin definitions.

2.2 Layout

Figure 2-1 shows the on-board peripheral connectors, rear panel peripheral connectors and on-board jumpers.

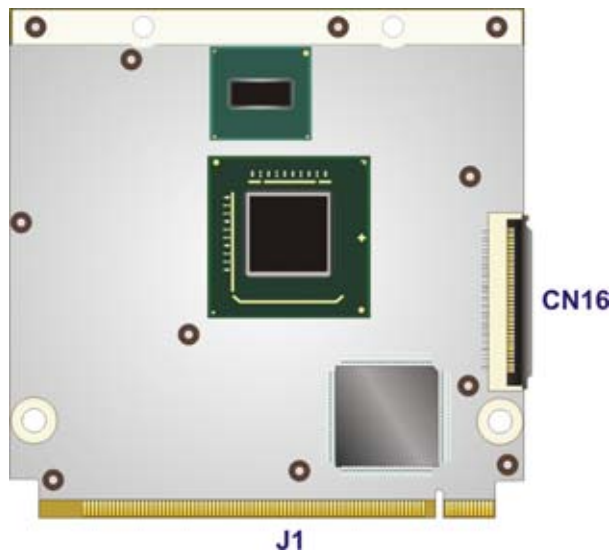

Figure 2-1: Connector and Jumper Locations

2.3 Connector Pinouts

Table 2-1 shows a list of the peripheral interface connectors on the IQ7-US15W. Detailed descriptions of these connectors can be found below.

Connector	Type	Label
QSeven Connector	QSeven connector	J1
IDE Connector	Flat cable	CN16

Table 2-1: Peripheral Interface Connectors

IQ7 Design Guide

Internal peripheral connectors are found on the motherboard and are only accessible when the motherboard is outside of the chassis. This section has complete descriptions of all the internal, peripheral connectors on the IQ7-US15W.

2.3.1 QSeven Connector

CN Label:	J1
CN Type:	QSeven connector
CN Location:	See Figure 2-2
CN Pinouts:	See Table 2-2

Provides the interface for all the connectors.

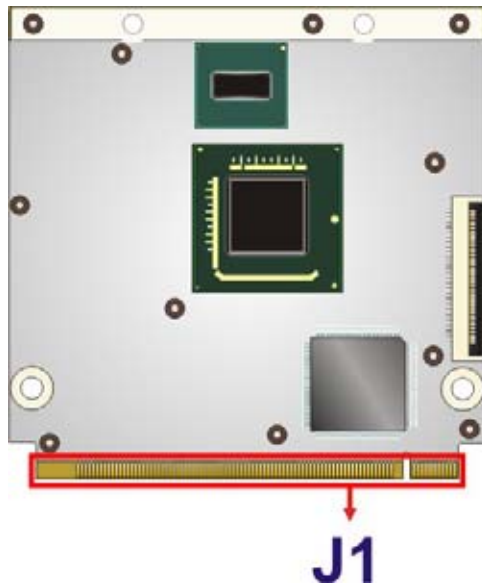

Figure 2-2: QSeven Connector

Pin	Description	Pin	Description
1	GND	2	GND
3	GBE_MD13-	4	GBE_MD12-
5	GBE_MD13+	6	GBE_MD12+
7	GBE_LINK100#	8	GBE_LINK1000#
9	GBE_MD11-	10	GBE_MD10-
11	GBE_MD11+	12	GBE_MD10+

Pin	Description	Pin	Description
13	GBE_LINK#	14	GBE_ACT#
15	GBE_CTREF	16	SUS_S5#
17	WAKE#	18	SUS_S3#
19	SUS_STAT#	20	PWRBTN#
21	SLP_BTN#	22	LID_BTN#
23	GND	24	GND
	KEY		KEY
25	GND	26	PWGIN
27	BATLOW#	28	RSTBTN#
29	SATA0_TX+	30	SATA1_TX+
31	SATA0_TX-	32	SATA1_TX-
33	SATA_ACT#	34	GND
35	SATA0_RX+	36	SATA1_RX+
37	SATA0_RX-	38	SATA1_RX-
39	GND	40	GND
41	BIOS_DISABLE#	42	SDIO_CLK#
43	SDIO_CD#	44	SDIO_LED
45	SDIO_CMD	46	SDIO_WP
47	SDIO_PWR#	48	SDIO_DAT1
49	SDIO_DAT0	50	SDIO_DAT3
51	SDIO_DAT2	52	SDIO_DAT5
53	SDIO_DAT4	54	SDIO_DAT7
55	SDIO_DAT6	56	RSVD
57	GND	58	GND
59	HDA_SYNC	60	SMB_CLK
61	HDA_RST#	62	SMB_DAT
63	HDA_BITCLK	64	SMB_ALERT#
65	HDA_SDI	66	I2C_CLK
67	HDA_SDO	68	I2C_DAT
69	THRM#	70	WDTRIG#
71	THRMTRIP#	72	WDOUT
73	GND	74	GND

IQ7 Design Guide

Pin	Description	Pin	Description
75	USB_P7-	76	USB_P6-
77	USB_P7+	78	USB_P6+
79	USB_6_7_OC#	80	USB_4_5_OC#
81	USB_P5-	82	USB_P4-
83	USB_P5+	84	USB_P4+
85	USB_2_3_OC#	86	USB_0_1_OC#
87	USB_P3-	88	USB_P2-
89	USB_P3+	90	USB_P2+
91	USB_HOST_PRES#	92	USB_HC_SEL
93	USB_P1-	94	USB_P0-
95	USB_P1+	96	USB_P0+
97	GND	98	GND
99	LVDS_A0+	100	LVDS_B0+
101	LVDS_A0-	102	LVDS_B0-
103	LVDS_A1+	104	LVDS_B1+
105	LVDS_A1-	106	LVDS_B1-
107	LVDS_A2+	108	LVDS_B2+
109	LVDS_A2-	110	LVDS_B2-
111	LVDS_PPEN	112	LVDS_BLEN
113	LVDS_A3+	114	LVDS_B3+
115	LVDS_A3-	116	LVDS_B3-
117	GND	118	GND
119	LVDS_A_CLK+	120	LVDS_B_CLK+
121	LVDS_A_CLK-	122	LVDS_B_CLK-
123	LVDS_BLT_CTRL	124	RSVD
125	LVDS_DID_DAT	126	LVDS_BLC_DAT
127	LVDS_DID_CLK	128	LVDS_BLC_CLK
129	RSVD	130	RSVD
131	SDVO_BCLK+	132	SDVO_INT+
133	SDVO_BCLK-	134	SDVO_INT-
135	GND	136	GND
137	SDVO_GREEN+	138	SDVO_FLDSTALL+

Pin	Description	Pin	Description
139	SDVO_GREEN-	140	SDVO_FLDSTALL-
141	GND	142	GND
143	SDVO_BLUE+	144	SDVO_TVCLKIN+
145	SDVO_BLUE-	146	SDVO_TVCLKIN-
147	GND	148	GND
149	SDVO_RED+	150	SDVO_CTRL_DAT
151	SDVO_RED-	152	SDVO_CTRL_CLK
153	HDMI_HPD#	154	DP_HPD#
155	PCIE_CLK_REF+	156	PCIE_WAKE#
157	PCIE_CLK_REF-	158	PCIE_RST#
159	GND	160	GND
161	PCIE3_TX+	162	PCIE3_RX+
163	PCIE3_TX-	164	PCIE3_RX-
165	GND	166	GND
167	PCIE2_TX+	168	PCIE2_RX+
169	PCIE2_TX-	170	PCIE2_RX-
171	EXCD0_PERST#	172	EXCD1_PERST#
173	PCIE1_TX+	174	PCIE1_RX+
175	PCIE1_TX-	176	PCIE1_RX-
177	EXCD0_CPPE#	178	EXCD1_CPPE#
179	PCIE0_TX+	180	PCIE0_RX+
181	PCIE0_TX-	182	PCIE0_RX-
183	GND	184	GND
185	LPC_AD0	186	LPC_AD1
187	LPC_AD2	188	LPC_AD3
189	LPC_CLK	190	LPC_FRAME#
191	SERIRQ	192	LPC_LDRO#
193	VCC_RTC	194	SPKR
195	FAN_TACHOIN	196	FAN_PWMOUT
197	GND	198	GND
199	RSVD	200	RSVD
201	RSVD	202	RSVD

IQ7 Design Guide

Pin	Description	Pin	Description
203	RSVD	204	MFG_NC4
205	VCC_5V_SB	206	VCC_5V_SB
207	MFG_NCO	208	MFG_NC2
209	MFG_NC1	210	MFG_NC3
211	VCC	212	VCC
213	VCC	214	VCC
215	VCC	216	VCC
217	VCC	218	VCC
219	VCC	220	VCC
221	VCC	222	VCC
223	VCC	224	VCC
225	VCC	226	VCC
227	VCC	228	VCC
229	VCC	230	VCC

Table 2-2: QSeven Connector

2.3.2 IDE Connector

CN Label: CN16

CN Type: Flat cable connector (FPC40P_0D5M-88511)

CN Location: See Figure 2-3

CN Pinouts: See Table 2-3

Connects to the baseboard through a flat panel connector, then to the IDE device through an IDE connector.

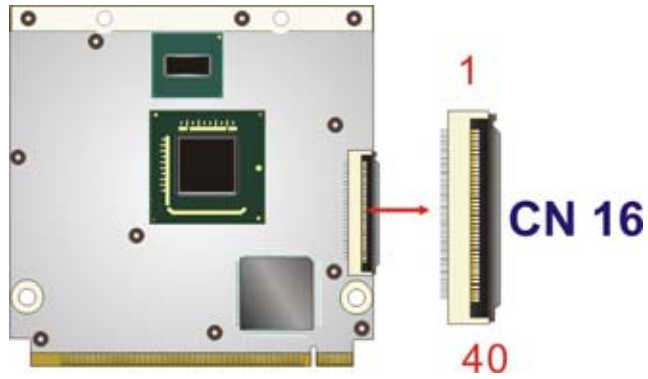

Figure 2-3: IDE Connector

Pin	Description
1	NC
2	NC
3	IDERST
4	GND
5	D7
6	D8
7	D6
8	D9
9	D5
10	D10
11	D4
12	D11
13	D3
14	D12
15	D2
16	D13
17	D1
18	D14
19	D0
20	D15
21	GND
22	DMARQ

IQ7 Design Guide

Pin	Description
23	GND
24	IOW#
25	IOR#
26	GND
27	IORDY
28	GND
29	DMACK#
30	IRQ
31	ADD1
32	CBLIB#
33	ADD0
34	ADD2
35	CS0
36	CS1
37	DASP
38	3.3V
39	3.3V
40	NC

Table 2-3: IDE Connector

Chapter

3

IQ7-DB-MITX

Introduction

3.1 Introduction

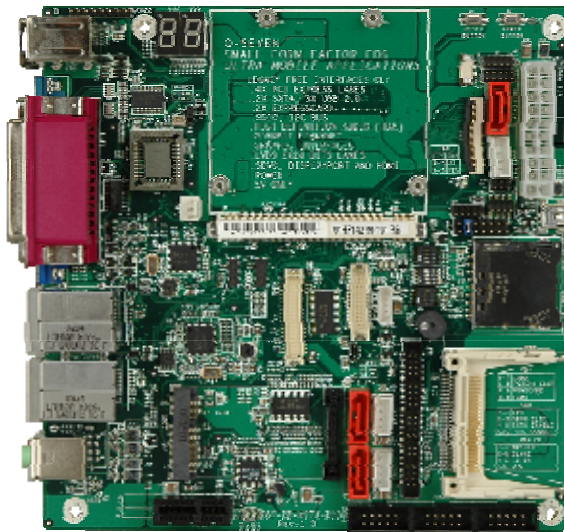

Figure 3-1: IQ7-DB-MITX

The IQ7-DB-MITX is a MiniITX baseboard for a QSeven CPU module. The QSeven standard specifies a TDP less than 12 W, ideal for low power, fanless applications.

The CPU and chipset are both a part of the CPU module, and the baseboard provides all the connectors.

Three SATA ports, a 44-pin IDE connection and a CompactFlash® card slot provide storage capabilities.

Graphics capabilities include a VGA port on the rear I/O panel through the SDVO connection. There is also an 18/24 bit LVDS and, optionally, LVDS to 18/24 bit TTL.

Networking is provided through two Gigabit Ethernet slots connected through PCIe x1 channels.

Expansion capabilities include a parallel port, PS/2 connectors, four serial ports, PCIe x1 expansion card slot and PCIe Mini card slot.

3.2 Benefits

Some of the IQ7-DB-MITX motherboard benefits include,

- Operating reliably in harsh industrial environments up to 70°C
- The system is always available and will reboot if the system crashes
- Powerful processor options are ideal for computing intensive applications

3.3 Features

Some of the IQ7-DB-MITX motherboard features are listed below:

- MiniITX form factor
- RoHS compliant
- QSeven CPU module connector
- Two Gigabit Ethernet controllers
- Integrated audio

IQ7 Design Guide

3.4 Connectors

The connectors on the IQ7-DB-MITX are shown in the figure below.

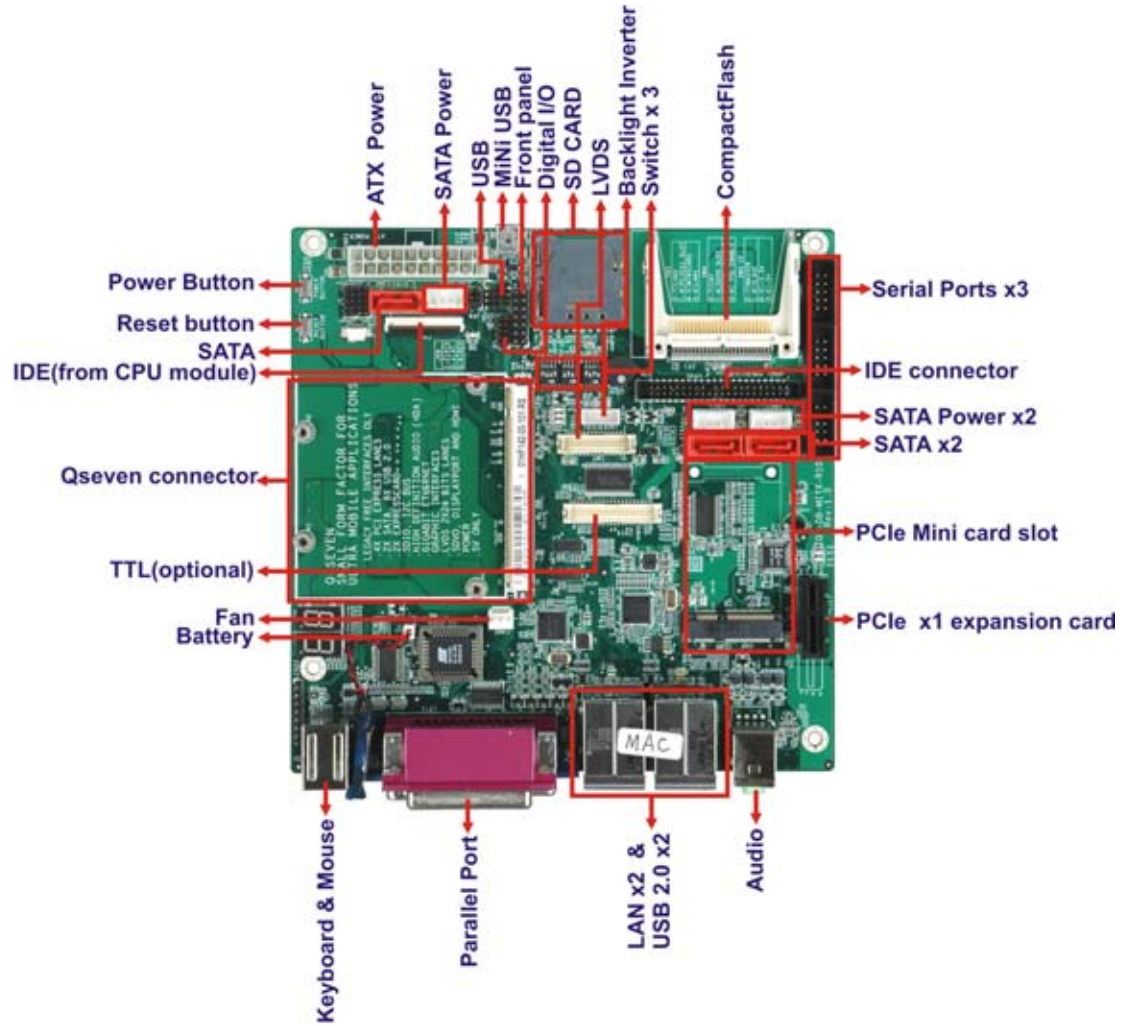

Figure 3-2: Top Connectors

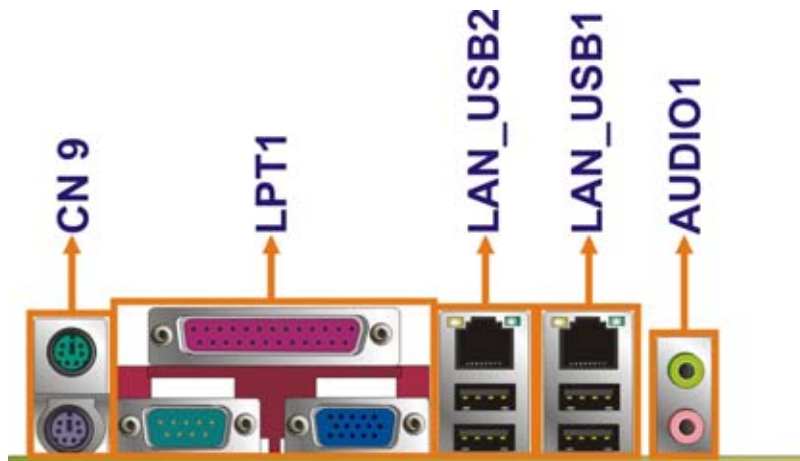

Figure 3-3: Rear Panel Connectors

3.5 Dimensions

The main dimensions of the IQ7-DB-MITX are shown in the diagram below.

- Length: 170 mm
- Width: 170 mm

IQ7 Design Guide

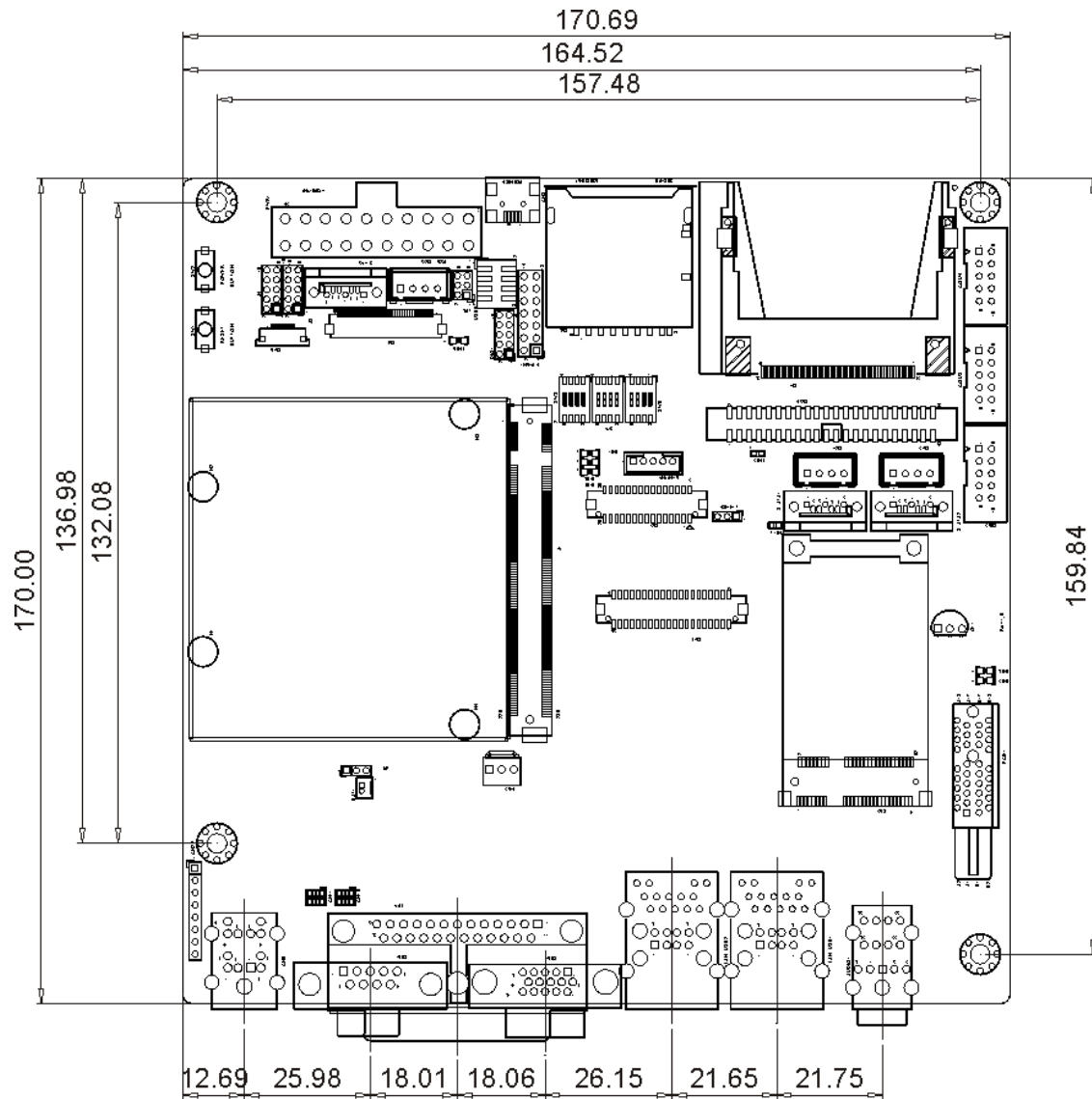

Figure 3-4: IQ7-DB-MITX Dimensions (mm)

The external peripheral interface connectors are shown below.

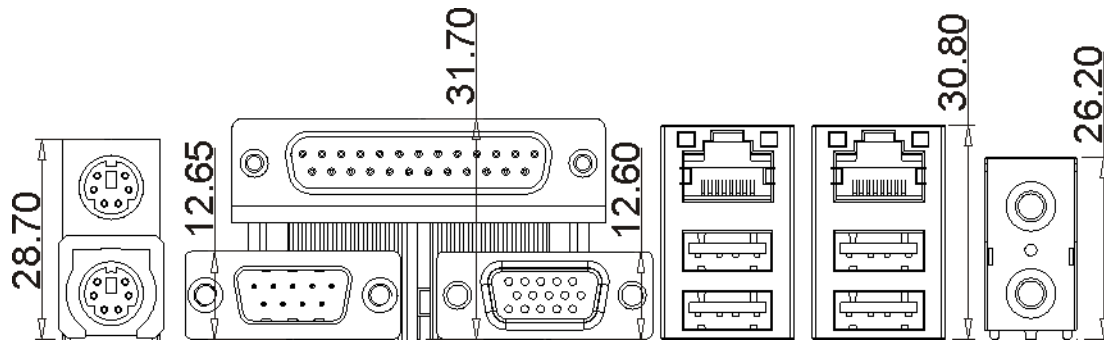

Figure 3-5: External Interface Panel Dimensions (mm)

IQ7 Design Guide

3.6 Data Flow

Figure 1-4 shows the data flow between the system chipset, the CPU and other components installed on the motherboard.

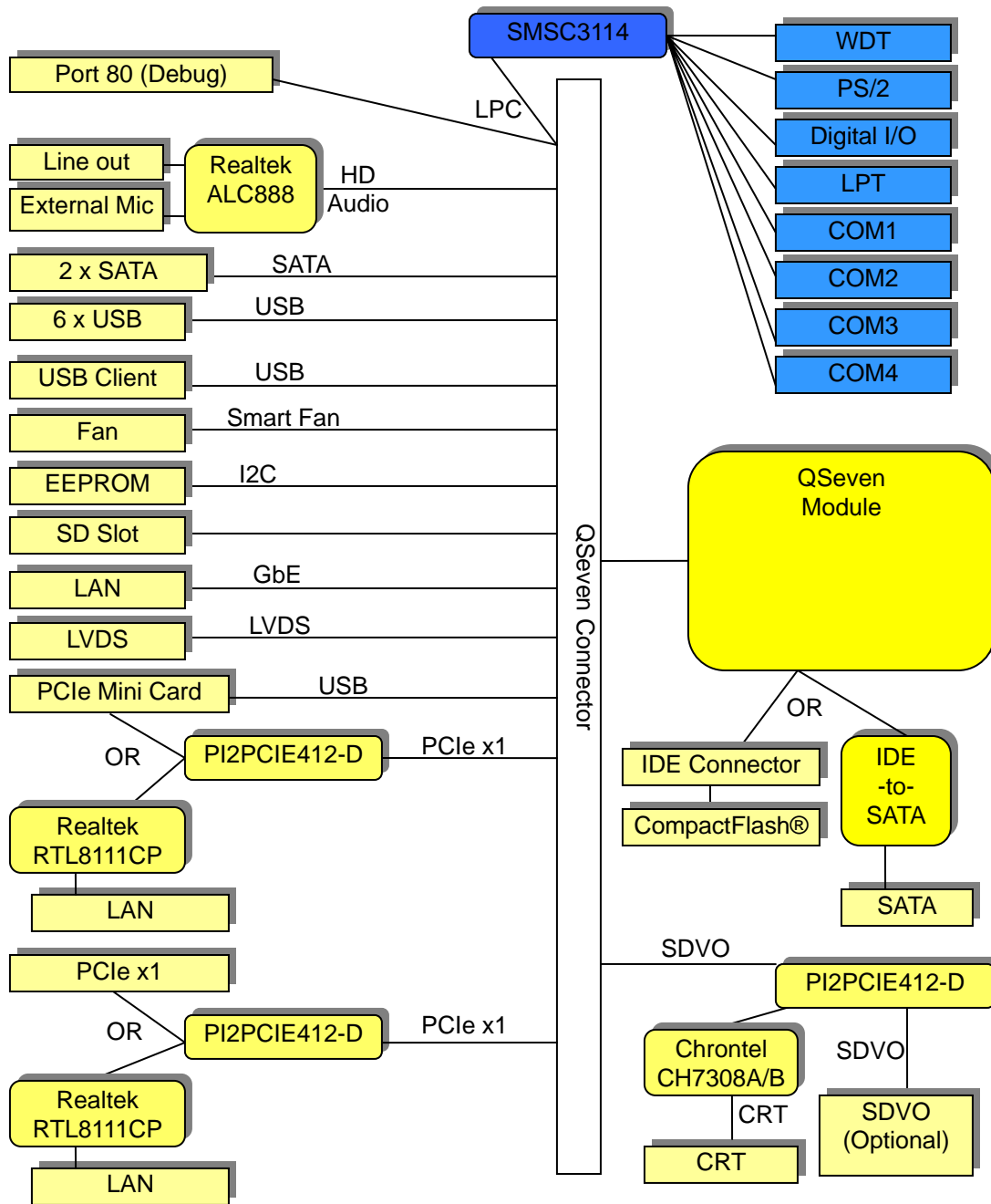

Figure 3-6: Data Flow Diagram

3.7 Technical Specifications

IQ7-DB-MITX technical specifications are listed in Table 1-1.

Specification	IQ7 Design Guide
Form Factor	MiniITX
CPU Module	QSeven
Front Side Bus (FSB)	400 MHz or 533 MHz
Audio	Realtek ALC888 High Definition Audio chip
LAN	Realtek RTL8111CP PCIe GbE chip Realtek RTL8111CP PCIe GbE chip
I/O Controller Chips	SMSC3114 Super I/O chip
Expansion	
PCIe	One PCIe x1 slot One Mini PCIe slot
I/O Interface Connectors	
Audio Connectors	Two external audio jacks (microphone in, line out)
Display port	One VGA One dual-channel 18/24 bit LVDS (LVDS to TTL optional)
Keyboard/Mouse	One dual PS/2 port
LPT	One parallel port
Serial Ports	Four serial ports
USB 2.0/1.1 ports	Four external USB ports One MiniUSB port
Storage	
Serial ATA	Two SATA connectors directly through Q7 connector One SATA connector through IDE-to-SATA from CPU module
Environmental and Power Specifications	
Power Supply	ATX supported

IQ7 Design Guide

Specification	IQ7 Design Guide
Operating temperature	-20°C ~ 70°C (requires cooler and silicone heat sink paste)
Humidity	0% ~ 95% (non-condensing)
Physical Specifications	
Dimensions	170 mm x 170 mm
Weight GW/NW	700 g x 350 g

Table 3-1: Technical Specifications

Chapter

4

IQ7-DB-MITX Connector Pinouts

4.1 Peripheral Interface Connectors

Section 4.1.2 shows peripheral interface connector locations. Section 4.1.2 lists all the peripheral interface connectors seen in Section 4.1.2.

4.1.1 Layout

Figure 2-1 shows the on-board peripheral connectors, rear panel peripheral connectors and on-board jumpers.

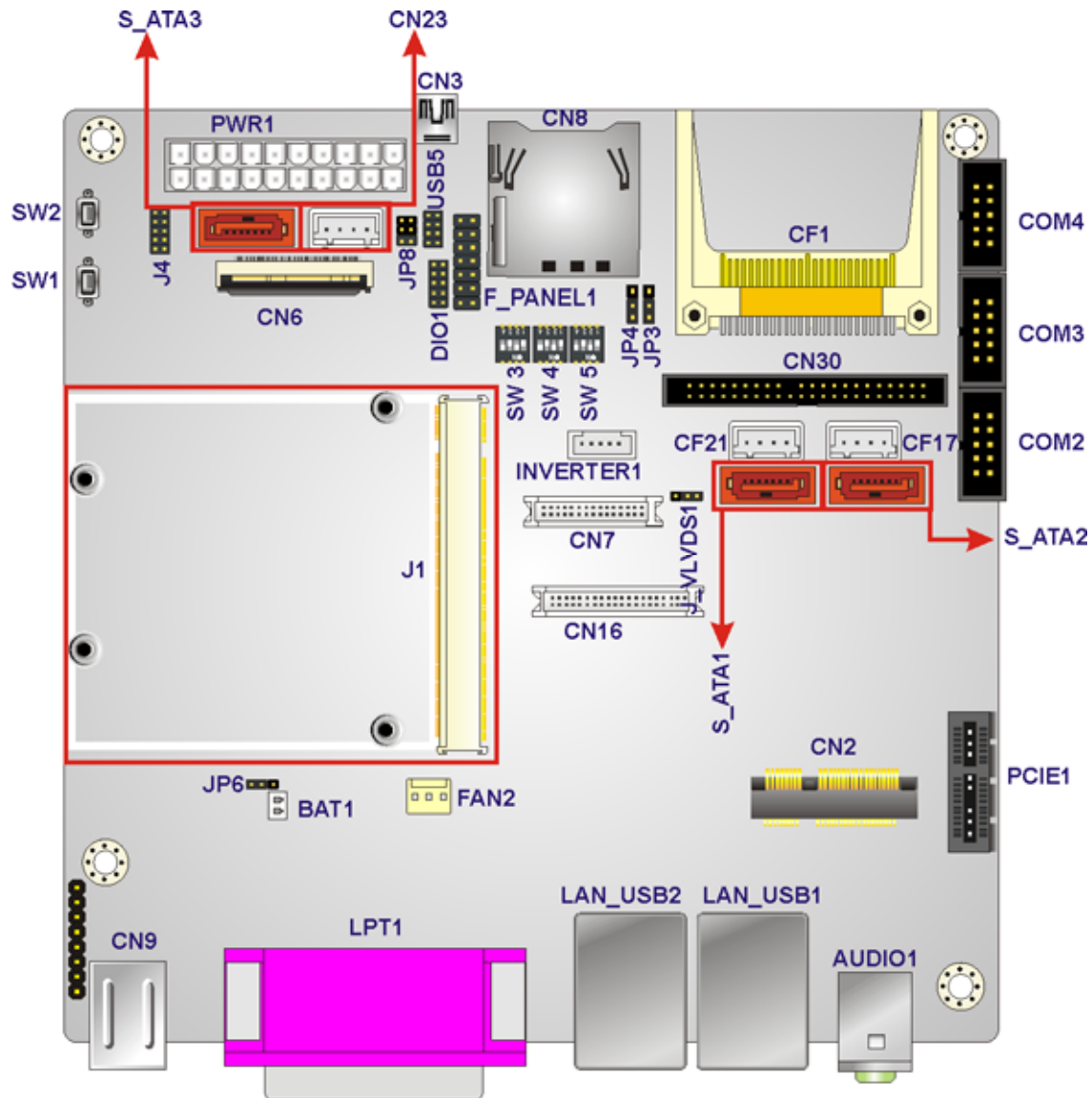

Figure 4-1: Connector and Jumper Locations

4.1.2 Peripheral Interface Connectors

Table 2-1 shows a list of the peripheral interface connectors on the IQ7-DB-MITX. Detailed descriptions of these connectors can be found below.

Connector	Type	Label
ATX power connector, system	20-pin ATX	PWR1
Backlight inverter connector	5-pin box header	INVERTER1
CompactFlash® connector	CF slot	CF1
Digital I/O	10-pin header	DIO1
Fan connector	3-pin wafer	FAN2
Front panel connector	14-pin header	F_PANEL1
IDE connector	44-pin	CN30
IDE (CPU module to baseboard)	Flat cable	CN6
LVDS connector	30-pin crimp	CN7
LVDS connector	40-pin crimp	CN16
Mini USB port	Mini-USB	USB_CLIENT
PCIe x1 expansion card slot	PCIe x1 slot	PCIE1
PCIe Mini card slot	PCIe Mini	CN2
Power button	Button	SW2
QSeven connector	QSeven	J1
Reset button	Button	SW1
SATA connectors	SATA	S_ATA1, S_ATA2, S_ATA3
SATA power	4-pin box header	CN17, CN21, CN23
Serial ports	10-pin box header	COM1, COM2, COM3
USB connector	8-pin header	USB5

Table 4-1: Peripheral Interface Connectors

4.1.3 External Interface Panel Connectors

Table 4-2 lists the rear panel connectors on the IQ7-DB-MITX. Detailed descriptions of these connectors can be found in **Section 2.1**.

Connector	Type	Label
Audio connectors	Audio jacks	AUDIO1
Keyboard and mouse connectors	Dual PS/2	CN9
LAN Connector	RJ-45	LAN_USB1 LAN_USB2
RS-232 serial port connector	D-sub 9-pin male	COM1
USB 2.0 ports	Dual USB ports	LAN_USB1 LAN_USB2
VGA port connector	15-pin female VGA	CON1

Table 4-2: Rear Panel Connectors

4.2 Internal Peripheral Connectors

Internal peripheral connectors are found on the motherboard and are only accessible when the motherboard is outside of the chassis. This section has complete descriptions of all the internal, peripheral connectors on the IQ7-DB-MITX.

4.2.1 ATX Power Connector

- CN Label:** PWR1
- CN Type:** 20-pin ATX (2x10)
- CN Location:** See Figure 2-3
- CN Pinouts:** See Table 2-3

The ATX connector is connected to an external ATX power supply. Power is provided to the system, from the power supply through this connector.

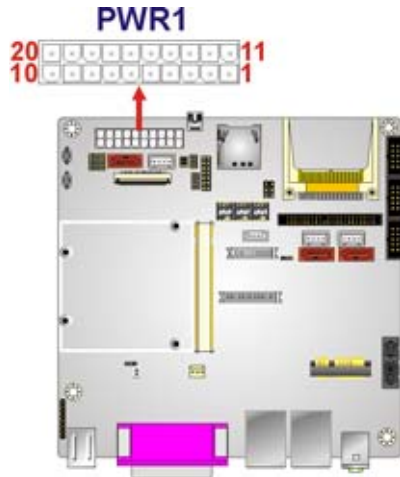

Figure 4-2: ATX Power Connector Pinout Locations

Pin	Description	Pin	Description
1	+3.3 V	13	+3.3 V
2	+3.3 V	14	-12 V
3	GND	15	GND
4	+5 V	16	PS-ON
5	GND	17	GND
6	+5 V	18	GND
7	GND	19	GND
8	NC	20	NC
9	+VCC5SB	21	+5 V
10	+12 V	22	+5 V

Table 4-3: ATX Power Connector Pinouts

4.2.2 Backlight Inverter Connector

- CN Label:** INVERTER1
- CN Type:** 5-pin box header
- CN Location:** See Figure 4-3
- CN Pinouts:** See Table 4-4

Provides power for the LCD backlight.

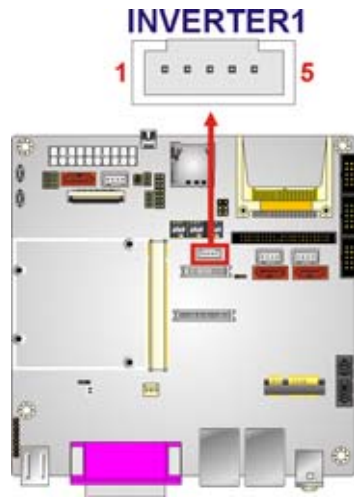

Figure 4-3: Backlight Inverter Connector

Pin	Description
1	BRIGHTNESS
2	GND
3	12 V
4	GND
5	BL_EN

Table 4-4: Backlight Inverter Connector

4.2.3 CompactFlash® Slot

- CN Label:** CF1
- CN Type:** CompactFlash® card slot
- CN Location:** See Figure 4-4

A CompactFlash® Type I/II card can be used in this slot.

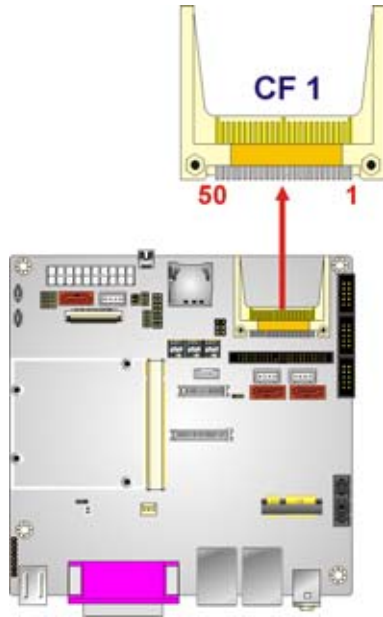

Figure 4-4: CompactFlash® Slot Location

4.2.4 Digital I/O Connector

CN Label:	DIO1
CN Type:	10-pin header
CN Location:	See Figure 4-5
CN Pinouts:	See Table 4-5

The digital I/O connector provides programmable input and output for external devices. The digital I/O provides 4-bit output and 4-bit input.

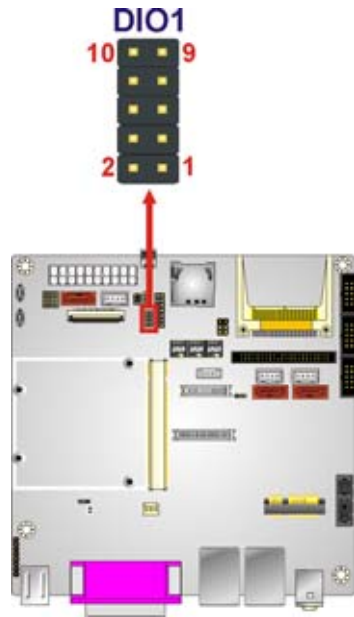

Figure 4-5: Digital I/O Connector Locations

Pin	Description	Pin	Description
1	GND	2	VCC
3	Output 0	4	Output 1
5	Output 2	6	Output 3
7	Input 0	8	Input 1
9	Input 2	10	Input 3

Table 4-5: Digital I/O Connector Pinouts

4.2.5 Fan Connector

- CN Label:** FAN2
- CN Type:** 3-pin header
- CN Location:** See Figure 4-6
- CN Pinouts:** See Table 4-6

Connects to a system cooling fan.

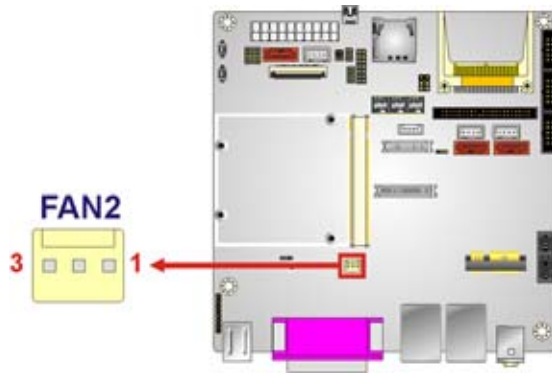

Figure 4-6: Fan Connector Location

Pin	Description
1	Rotation signal
2	+12 V
3	Ground

Table 4-6: Fan Connector Pinouts

4.2.6 Front Panel Connector

- CN Label:** F_PANEL1
- CN Type:** 14-pin header (2x7)
- CN Location:** See Figure 4-7
- CN Pinouts:** See Table 4-7

The front panel connector connects to external switches and indicators to monitor and control the motherboard. These indicators and switches include:

- Power button
- Reset button
- Power LED
- HDD LED
- Speaker

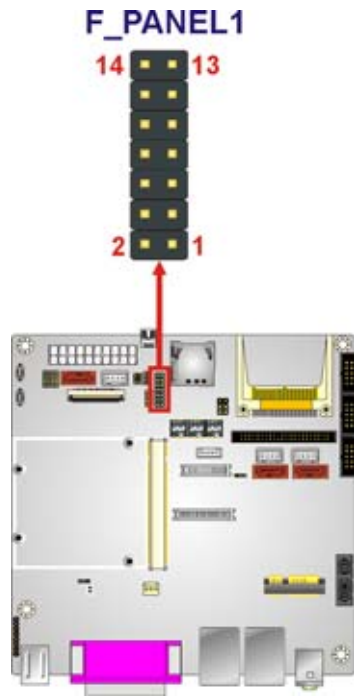

Figure 4-7: Front Panel Connector Pinout Locations

Pin	Description	Pin	Description
1	Power LED+	2	Speaker+
3	N/C	4	N/C
5	Power LED-	6	N/C
7	Power Button+	8	Speaker-
9	Power Button-	10	N/C
11	HDD LED+	12	Reset+
13	HDD LED-	14	Reset-

Table 4-7: Front Panel Connector Pinouts

4.2.7 IDE Connector

- CN Label:** CN30
- CN Type:** 44-pin box header (2x22)
- CN Location:** See Figure 4-8
- CN Pinouts:** See Table 4-8

The IDE connector can connect to an IDE hard drive or optical device.

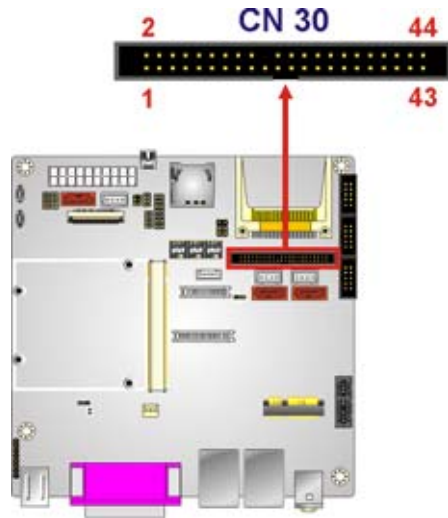

Figure 4-8: IDE Connector Locations

Pin	Description	Pin	Description
1	RESET#	2	GROUND
3	DATA 7	4	DATA 8
5	DATA 6	6	DATA 9
7	DATA 5	8	DATA 10
9	DATA 4	10	DATA 11
11	DATA 3	12	DATA 12
13	DATA 2	14	DATA 13
15	DATA 1	16	DATA 14
17	DATA 0	18	DATA 15
19	GROUND	20	N/C
21	IDE DRQ	22	GROUND
23	IOW#	24	GROUND
25	IOR#	26	GROUND
27	IDE CHRDY	28	GROUND
29	IDE DACK	30	GROUND-DEFAULT
31	INTERRUPT	32	N/C
33	SA1	34	N/C
35	SA0	36	SA2

IQ7 Design Guide

Pin	Description	Pin	Description
37	HDC CS0#	38	HDC CS1#
39	HDD ACTIVE#	40	GROUND
41	VCC	42	VCC
43	GROUND	44	N/C

Table 4-8: IDE Connector Pinouts

4.2.8 IDE (CPU Module to Baseboard)

- CN Label:** CN6
- CN Type:** 40-pin flat cable
- CN Location:** See Figure 4-9
- CN Pinouts:** See Table 4-9

Connects the IDE channel from the CPU module to the baseboard. IDE is not a supported I/O interface for the QSeven standard, so the flat cable optionally provides this interface, which is commonly supported by the Southbridge on the CPU module.

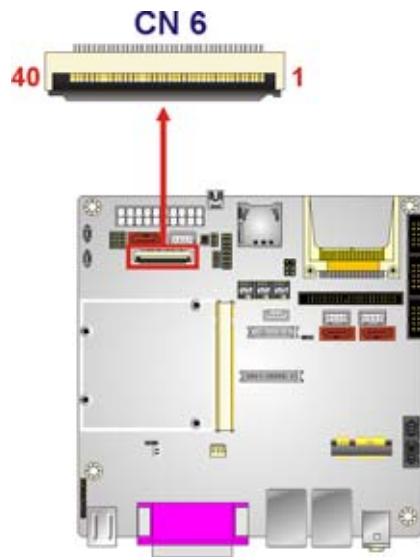

Figure 4-9: CPU Module to Baseboard IDE Connector Location

Pin	Description	Pin	Description
1	Power LED+	2	Speaker+

Pin	Description	Pin	Description
3	N/C	4	N/C
5	Power LED-	6	N/C
7	Power Button+	8	Speaker-
9	Power Button-	10	N/C
11	HDD LED+	12	Reset+
13	HDD LED-	14	Reset-

Table 4-9: CPU Module to Baseboard IDE Pinouts

4.2.9 LVDS Connector

CN Label: CN7

CN Type: 30-pin crimp (2x15) DF-13, 180°, P=1.25 mm

CN Location: See Figure 4-10

CN Pinouts: See Table 4-10

The LVDS connector is for an LCD panel connected to the board.

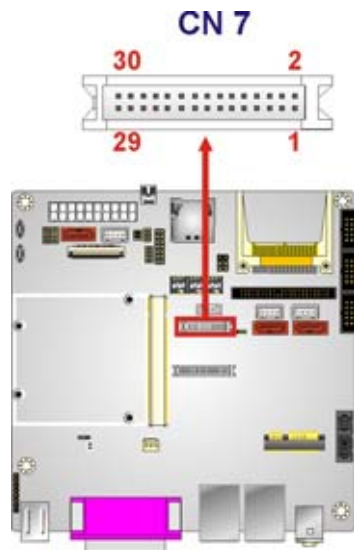

Figure 4-10: LVDS Connector Location

Pin	Description	Pin	Description
1	GROUND	2	GROUND

IQ7 Design Guide

Pin	Description	Pin	Description
3	A_Y0+	4	A_Y0-
5	A_Y1+	6	A_Y1-
7	A_Y2+	8	A_Y2-
9	A_CLK+	10	A_CLK-
11	N/C	12	N/C
13	GROUND	14	GROUND
15	B_Y0+	16	B_Y0-
17	B_Y1+	18	B_Y1-
19	B_Y2+	20	B_Y2-
21	B_CLK+	22	B_CLK-
23	N/C	24	N/C
25	GROUND	26	GROUND
27	VCC	28	VCC
29	VCC	30	VCC

Table 4-10: LVDS Connector Pinouts

4.2.10 Mini USB Port

CN Label: USB_CLIENT

CN Type: Mini-USB

CN Location: See Figure 4-11

CN Pinouts: See Table 4-11

Connects to a USB host device.

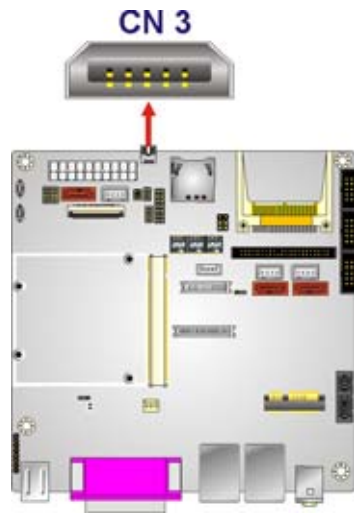

Figure 4-11: Mini USB Port Location

Pin	Description
1	+5 V
2	D-
3	D+
4	NC
5	GND

Table 4-11: Mini USB Port Pinouts

4.2.11 PCI Express x1 Slot

- CN Label:** PCIE1
- CN Type:** PCIe x1 expansion card slot
- CN Location:** See Figure 4-12

PCIe x1 expansion devices can be inserted into the PCIe x1 slots.

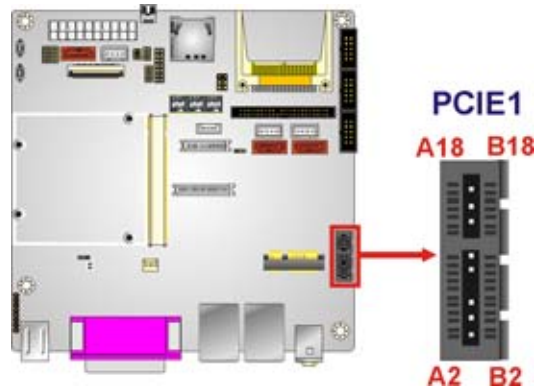

Figure 4-12: PCIe x1 Connector Location

Pin	Description	Pin	Description
A1	+12v	B1	PRSNT#1
A2	+12v	B2	+12v
A3	RSVD	B3	+12v
A4	GND	B4	GND
A5	SMCLK	B5	JTAG2
A6	SMDAT	B6	JTAG3
A7	GND	B7	JTAG4
A8	+3.3v	B8	JTAG5
A9	JTAG1	B9	+3.3v
A10	3.3 Vaux	B10	+3.3v
A11	WAKE#	B11	PWRGD
A12	RSVD	B12	GND
A13	GND	B13	REFCLK+
A14	HSOp(0)	B14	REFCLK-
A15	HSOn(0)	B15	GND
A16	GND	B16	HSIp(0)
A17	PRSNT#2	B17	HSIn(0)
A18	GND	B18	GND

Table 4-12: PCIe x1 Slot Pinouts

4.2.12 PCIe Mini Card Slot

CN Label: CN2

CN Type: PCIe Mini card slot 52-pin, 90°, P=0.8 mm & 180°, 9.0H

CN Location: See Figure 4-13

CN Pinouts: See Table 4-13

The PCIe Mini card slot is for installing PCIe Mini expansion cards.

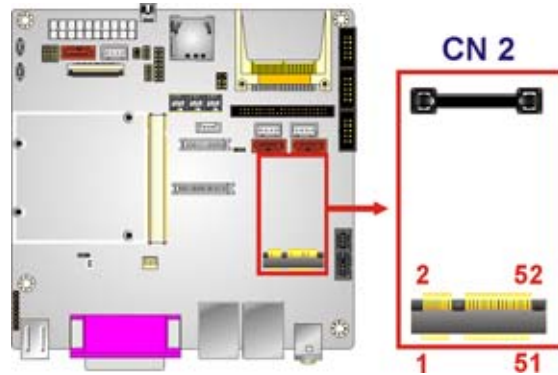

Figure 4-13: PCIe Mini Card Slot Location

Pin	Description	Pin	Description
1	PCIE_WAKE#	2	VCC3
3	N/C	4	GND
5	N/C	6	1.5 V
7	CLKREQ#	8	LFRAME#
9	GND	10	LAD3
11	CLK-	12	LAD2
13	CLK+	14	LAD1
15	GND	16	LAD0
17	PCIRST#	18	GND
19	LPC	20	VCC3
21	GND	22	PCIRST#
23	PERN2	24	3 VDual
25	PERP2	26	GND
27	GND	28	1.5 V
29	GND	30	SMBCLK
31	PETN2	32	SMBDATA
33	PETP2	34	GND

Pin	Description	Pin	Description
35	GND	36	USBD-
37	N/C	38	USBD+
39	N/C	40	GND
41	N/C	42	N/C
43	N/C	44	RF_LINK#
45	N/C	46	BLUELED#
47	N/C	48	1.5 V
49	N/C	50	GND
51	N/C	52	VCC3

Table 4-13: PCIe Mini Card Slot Pinouts

4.2.13 Power Button

- CN Label:** SW2
- CN Type:** Button
- CN Location:** See Figure 4-14

The power button turns the power on and off.

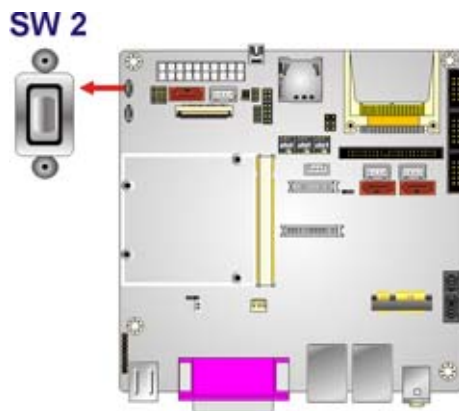

Figure 4-14: Power Button Location

4.2.14 QSeven Connector

- CN Label:** J1

CN Type: QSeven connector, MXM, 230-pin, 90°, P=0.5 mm

CN Location: See Figure 4-15

CN Pinouts: See Table 4-14

The QSeven CPU module is installed in this slot.

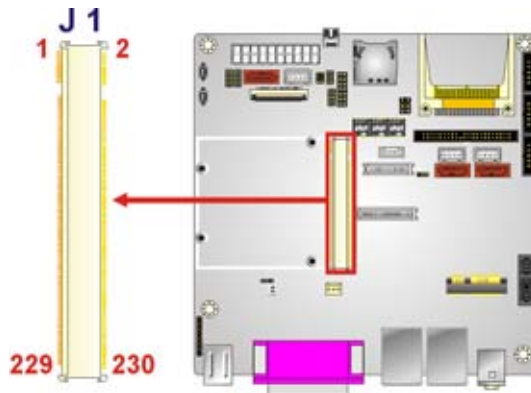

Figure 4-15: QSeven Connector Location

Pin	Description	Pin	Description
1	GND	2	GND
3	GBE_MDI3-	4	GBE_MDI2-
5	GBE_MDI3+	6	GBE_MDI2+
7	GBE_LINK100#	8	GBE_LINK1000#
9	GBE_MDI1-	10	GBE_MDI0-
11	GBE_MDI1+	12	GBE_MDI0+
13	GBE_LINK#	14	GBE_ACT#
15	GBE_CTREF	16	SUS_S5#
17	WAKE#	18	SUS_S3#
19	SUS_STAT#	20	PWRBTN#
21	SLP_BTN#	22	LID_BTN#
23	GND	24	GND
KEY	KEY	KEY	KEY
25	GND	26	PWGIN
27	BATLOW#	28	RSTBTN#

IQ7 Design Guide

29	SATA0_TX+	30	SATA1_TX+
31	SATA0_TX-	32	SATA1_TX-
33	SATA_ACT#	34	GND
35	SATA0_RX+	36	SATA1_RX+
37	SATA0_RX-	38	SATA1_RX-
39	GND	40	GND
41	BIOS_DISABLE#	42	SDIO_CLK#
43	SDIO_CD#	44	SDIO_LED
45	SDIO_CMD	46	SDIO_WP
47	SDIO_PWR#	48	SDIO_DAT1
49	SDIO_DAT0	50	SDIO_DAT3
51	SDIO_DAT2	52	SDIO_DAT5
53	SDIO_DAT4	54	SDIO_DAT7
55	SDIO_DAT6	56	RSVD
57	GND	58	GND
59	HDA_SYNC	60	SMB_CLK
61	HDA_RST#	62	SMB_DAT
63	HDA_BITCLK	64	SMB_ALERT#
65	HDA_SDI	66	I2C_CLK
67	HDA_SDO	68	I2C_DAT
69	THRM#	70	WDTRIG#
71	THRMTRIP#	72	WDOUT
73	GND	74	GND
75	USB_P7-	76	USB_P6-
77	USB_P7+	78	USB_P6+
79	USB_6_7_OC#	80	USB_4_5_OC#
81	USB_P5-	82	USB_P4-
83	USB_P5+	84	USB_P4+
85	USB_2_3_OC#	86	USB_0_1_OC#
87	USB_P3-	88	USB_P2-
89	USB_P3+	90	USB_P2+
91	USB_HOST_PRES#	92	USB_HC_SEL
93	USB_P1-	94	USB_P0-
95	USB_P1+	96	USB_P0+

97	GND	98	GND
99	LVDS_A0+	100	LVDS_B0+
101	LVDS_A0-	102	LVDS_B0-
103	LVDS_A1+	104	LVDS_B1+
105	LVDS_A1-	106	LVDS_B1-
107	LVDS_A2+	108	LVDS_B2+
109	LVDS_A2-	110	LVDS_B2-
111	LVDS_PPEN	112	LVDS_BLEN
113	LVDS_A3+	114	LVDS_B3+
115	LVDS_A3-	116	LVDS_B3-
117	GND	118	GND
119	LVDS_A_CLK+	120	LVDS_B_CLK+
121	LVDS_A_CLK-	122	LVDS_B_CLK-
123	LVDS_BLT_CTRL	124	RSVD
125	LVDS_DID_DAT	126	LVDS_BLC_DAT
127	LVDS_DID_CLK	128	LVDS_BLC_CLK
129	RSVD	130	RSVD
131	SDVO_BCLK+	132	SDVO_INT+
133	SDVO_BCLK-	134	SDVO_INT-
135	GND	136	GND
137	SDVO_GREEN+	138	SDVO_FLDSTALL+
139	SDVO_GREEN-	140	SDVO_FLDSTALL-
141	GND	142	GND
143	SDVO_BLUE+	144	SDVO_TVCLKIN+
145	SDVO_BLUE-	146	SDVO_TVCLKIN-
147	GND	148	GND
149	SDVO_RED+	150	SDVO_CTRL_DAT
151	SDVO_RED-	152	SDVO_CTRL_CLK
153	HDMI_HPD#	154	DP_HPD#
155	PCIE_CLK_REF+	156	PCIE_WAKE#
157	PCIE_CLK_REF-	158	PCIE_RST#
159	GND	160	GND
161	PCIE3_TX+	162	PCIE3_RX+
163	PCIE3_TX-	164	PCIE3_RX-

IQ7 Design Guide

165	GND	166	GND
167	PCIE2_TX+	168	PCIE2_RX+
169	PCIE2_TX-	170	PCIE2_RX-
171	EXCD0_PERST#	172	EXCD1_PERST#
173	PCIE1_TX+	174	PCIE1_RX+
175	PCIE1_TX-	176	PCIE1_RX-
177	EXCD0_CPPE#	178	EXCD1_CPPE#
179	PCIE0_TX+	180	PCIE0_RX+
181	PCIE0_TX-	182	PCIE0_RX-
183	GND	184	GND
185	LPC_ADO	186	LPC_AD1
187	LPC_AD2	188	LPC_AD3
189	LPC_CLK	190	LPC_FRAME#
191	SERIRQ	192	LPC_LDRO#
193	VCC_RTC	194	SPKR
195	FAN_TACHOIN	196	FAN_PWMOUT
197	GND	198	GND
199	RSVD	200	RSVD
201	RSVD	202	RSVD
203	RSVD	204	MFG_NC4
205	VCC_5V_SB	206	VCC_5V_SB
207	MFG_NC0	208	MFG_NC2
209	MFG_NC1	210	MFG_NC3
211	VCC	212	VCC
213	VCC	214	VCC
215	VCC	216	VCC
217	VCC	218	VCC
219	VCC	220	VCC
221	VCC	222	VCC
223	VCC	224	VCC
225	VCC	226	VCC
227	VCC	228	VCC

229	VCC	230	VCC
-----	-----	-----	-----

Table 4-14: QSeven Connector Pinouts

4.2.15 Reset Button

- CN Label:** SW1
- CN Type:** Button
- CN Location:** See Figure 4-16

Press the reset button to reset the system.

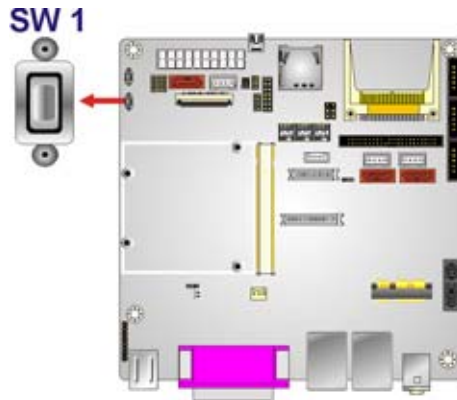
Figure 4-16: Reset Button Location

4.2.16 SATA Drive Connectors

- CN Label:** S_ATA1, S_ATA2, S_ATA3
- CN Type:** SATA drive connectors
- CN Location:** See Figure 4-17

The SATA connectors can be connected to SATA peripheral devices like hard drives and optical drives.

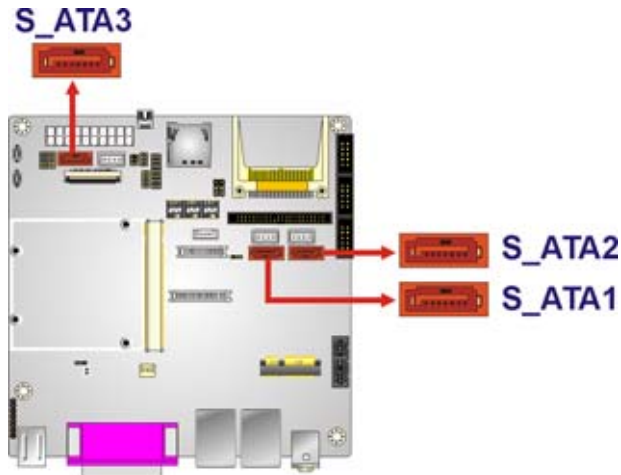

Figure 4-17: SATA Drive Connector Locations

4.2.17 SATA Power Connectors

- CN Label:** CN17, CN21, CN23
- CN Type:** 4-pin wafer (1x4), 180°, P=2.5 mm
- CN Location:** See Figure 4-18
- CN Pinouts:** See Table 4-15

The SATA power connectors provide power to connected SATA devices like SATA hard drives or optical drives.

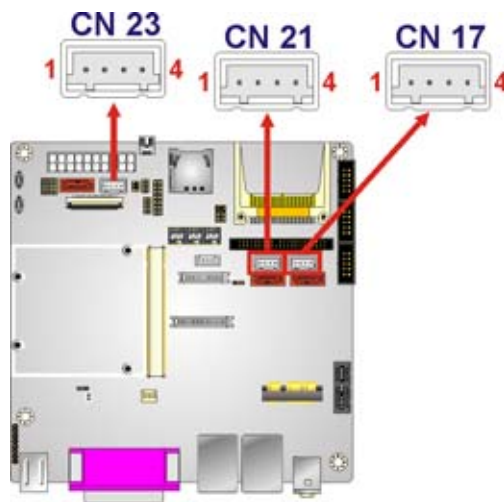

Figure 4-18: SATA Power Connector Locations

Pin	Description
1	+5 V
2	GND
3	GND
4	+12 V

Table 4-15: SATA Power Connector Pinouts

4.2.18 SDVO Connector

CN Label: SDVO1

CN Type: Flat cable

CN Pinouts: See Table 4-8

The SDVO connector is an optional extra that can attach to an SDVO graphics card.

Pin	Description	Pin	Description
1	RESET#	2	GROUND
3	DATA 7	4	DATA 8
5	DATA 6	6	DATA 9
7	DATA 5	8	DATA 10
9	DATA 4	10	DATA 11
11	DATA 3	12	DATA 12
13	DATA 2	14	DATA 13
15	DATA 1	16	DATA 14
17	DATA 0	18	DATA 15
19	GROUND	20	N/C
21	IDE DRQ	22	GROUND
23	IOW#	24	GROUND
25	IOR#	26	GROUND
27	IDE CHRDY	28	GROUND
29	IDE DACK	30	GROUND-DEFAULT
31	INTERRUPT	32	N/C
33	SA1	34	N/C

IQ7 Design Guide

Pin	Description	Pin	Description
35	SA0	36	SA2
37	HDC CS0#	38	HDC CS1#
39	HDD ACTIVE#	40	GROUND
41	VCC	42	VCC
43	GROUND	44	N/C

Table 4-16: IDE Connector Pinouts

4.2.19 Serial Port Connectors

- CN Label:** COM2, COM3, COM4
- CN Type:** 10-pin box header (2x5), 180°, P=2.5 mm
- CN Location:** See Figure 4-19
- CN Pinouts:** See Table 4-17

The serial ports provide RS-232 transmission capabilities.

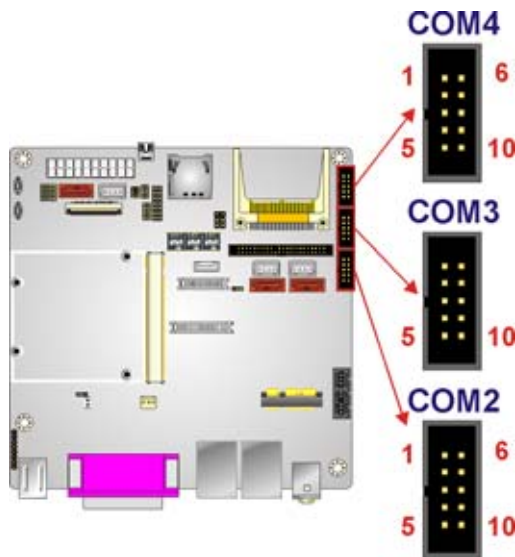

Figure 4-19: Serial Port Connector Locations

Pin	Description	Pin	Description
1	DCD1	2	DSR1
3	RXD1	4	RTS1

Pin	Description	Pin	Description
5	TXD1	6	CTS1
7	DTR1	8	RI1
9	GND1	10	GND1

Table 4-17: Serial Port Connector Pinouts

4.2.20 TTL Connector

CN Label: CN16

CN Type: 40-pin crimp (2x20) DF-13, 180°, P=1.25 mm

CN Location: See Figure 4-20

CN Pinouts: See Table 4-18

The TTL connector is for an LCD panel connected to the board.

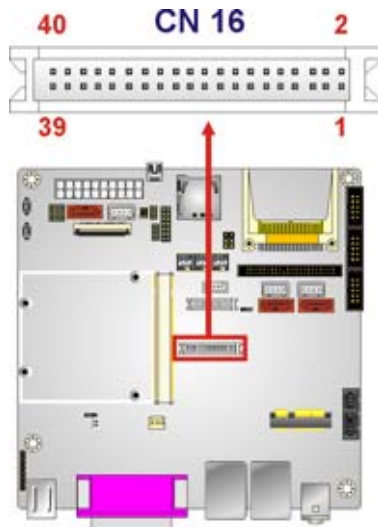
Figure 4-20: TTL Connector Location

Pin	Description	Pin	Description
1	+3.3V	2	+3.3V
3	GND	4	GND
5	+3.3V	6	+3.3V
7	SMB_DAT	8	GND
9	TFT_BO	10	TFT_B1

Pin	Description	Pin	Description
11	TFT_B2	12	TFT_B3
13	TFT_B4	14	TFT_B5
15	TFT_B6	16	TFT_B7
17	TFT_G0	18	TFT_G1
19	TFT_G2	20	TFT_G3
21	TFT_G4	22	TFT_G5
23	TFT_G6	24	TFT_G7
25	TFT_R0	26	TFT_R1
27	TFT_R2	28	TFT_R3
29	TFT_R4	30	TFT_R5
31	TFT_R6	32	TFT_R7
33	GND	34	GND
35	VOCLK	36	VSYNC
37	VDEN	38	HSYNC
39	SMB_CLK	40	LVDS_BKLT_EN

Table 4-18: TTL Connector Pinouts

4.2.21 USB Connector

- CN Label:** USB5
- CN Type:** 8-pin header (2x4) 180°, P=2.0 mm
- CN Location:** See Figure 4-21
- CN Pinouts:** See Table 4-19

The USB header can connect to two USB devices.

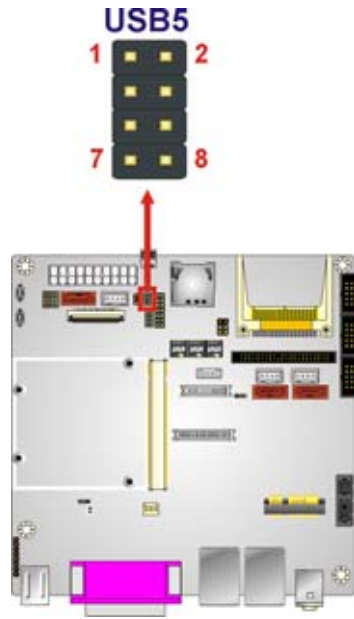

Figure 4-21: USB Connector Locations

Pin	Description	Pin	Description
1	VCC	2	GND
3	DATA-	4	DATA+
5	DATA+	6	DATA-
7	GND	8	VCC

Table 4-19: USB Port Connector Pinouts

4.3 External Interface Connectors

Figure 4-22 shows the IQ7-DB-MITX motherboard external interface connectors. The IQ7-DB-MITX on-board external interface connectors are shown in Figure 4-22.

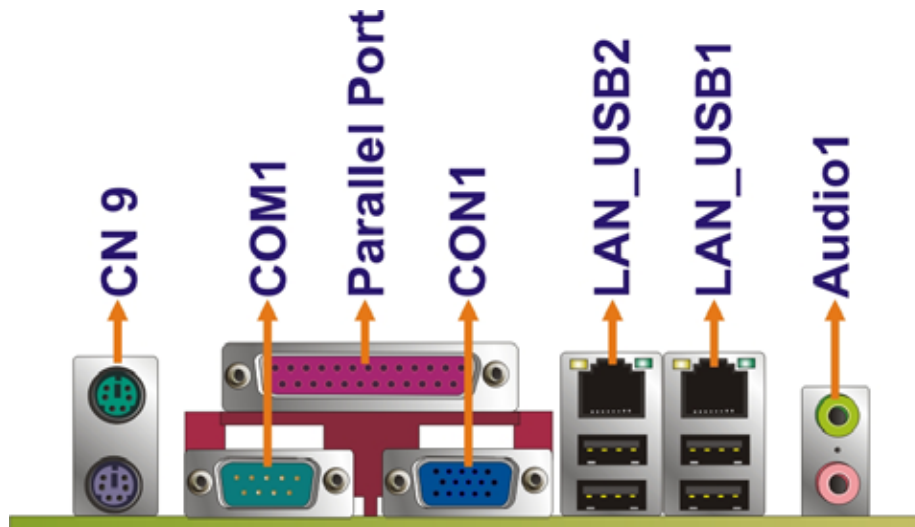

Figure 4-22: External Interface Connectors

4.3.1 Audio Connector

CN Label:	AUDIO1
CN Type:	Audio jacks, 14-pin, 90°, P=2.5 mm
CN Location:	See Figure 4-22
CN Pinouts:	See Table 4-20

The audio jacks connect to external audio devices.

- **Line Out port (Lime):** Connects to a headphone or a speaker.
- **Microphone (Pink):** Connects a microphone.

Figure 4-23: Audio Connector

Pin	Description	Pin	Description
1	Ground	2	LMIC1-L
3	NC	4	NC
5	LMIC1-R	22	LFRONT-L
23	NC	24	NC
25	LFRONT-R		

Table 4-20: Audio Connector Pinouts

4.3.2 Ethernet Connector

CN Label: LAN1_USB01, LAN2_USB23

CN Type: RJ-45

CN Location: See Figure 4-22

CN Pinouts: See Table 4-21

A 10/100/1000 Mb/s connection can be made to a Local Area Network.

Pin	Description	Pin	Description
1	MDIA3-	5	MDIA1+
2	MDIA3+	6	MDIA2+
3	MDIA2-	7	MDIA0-
4	MDIA1-	8	MDIA0+

Table 4-21: Ethernet Connector Pinouts

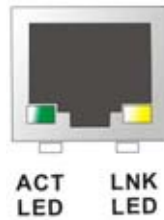

Figure 4-24: Ethernet Connector

The RJ-45 Ethernet connector has two status LEDs, one green and one yellow. The green LED indicates activity on the port and the yellow LED indicates the port is linked.

SPEED LED		LINK LED	
Status	Description	Status	Description
GREEN	ON: 100 MB OFF: 10 MB	YELLOW	ON: Linked Flashing: Activity

Table 4-22: Connector LEDs

4.3.3 Keyboard and Mouse Connector

- CN Label:** KB_MS1
- CN Type:** PS/2
- CN Location:** See Figure 4-22
- CN Pinouts:** See Table 4-23 and Figure 4-25

The IQ7-DB-MITX has two PS/2 connectors on the mounting bracket for easy connection to a PS/2 keyboard and PS/2 mouse.

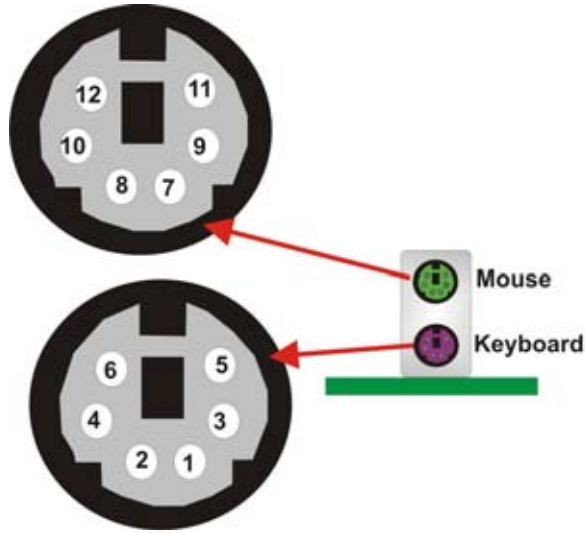

Figure 4-25: PS/2 Connector

Pin	Description	Pin	Description
1	KEYBOARD DATA	7	MOUSE DATA
2	NC	8	NC
3	GND	9	GND
4	+5 V	10	+5 V
5	KEYBOARD CLOCK	11	MOUSE DATA
6	NC	12	NC

Table 4-23: PS/2 Connectors

4.3.4 Parallel Port Connector

- CN Label:** LPT1
- CN Type:** D-SUB 25-pin 90° H=31.6 mm
- CN Location:** See Figure 4-22
- CN Pinouts:** See Table 4-24

The parallel port connects to parallel port device, typically a printer.

Pin	Description	Pin	Description
1	STROBE#	14	AUTO FORM FEED #
2	DATA 0	15	ERROR#

IQ7 Design Guide

Pin	Description	Pin	Description
3	DATA 1	16	INITIALIZE
4	DATA 2	17	PRINTER SELECT LN#
5	DATA 3	18	GROUND
6	DATA 4	19	GROUND
7	DATA 5	20	GROUND
8	DATA 6	21	GROUND
9	DATA 7	22	GROUND
10	ACKNOWLEDGE	23	GROUND
11	BUSY	24	GROUND
12	PAPER EMPTY	25	GROUND
13	PRINTER SELECT		

Table 4-24: Parallel Port Connector Pinouts



Figure 4-26: Parallel Port Connector Location

4.3.5 Serial Port Connector

- CN Label:** COM1
- CN Type:** DB-9 connector
- CN Location:** See Figure 4-22
- CN Pinouts:** See Table 4-25 and Figure 4-27

The RS-232 serial connector provides serial connection in the RS-232 mode.

Pin	Description
1	DCD
2	RXD
3	TXD

Pin	Description
4	DTR
5	GND
6	DSR
7	RTS
8	CTS
9	RI
10	GND
11	GND

Table 4-25: Serial Port Pinouts

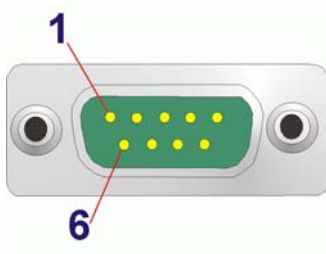

Figure 4-27: Serial Port Pinout Locations

4.3.6 USB Ports

CN Label: LAN1_USB01, LAN2_USB23, USB4_7

CN Type: USB Combo ports

CN Location: See Figure 4-22

CN Pinouts: See Table 4-26

The USB ports attach to standard USB devices.

Pin	Description
1	VCC
2	Data-
3	Data+

IQ7 Design Guide

Pin	Description
4	Ground

Table 4-26: USB Connector Pinouts

4.3.7 VGA Connector

- CN Label:** CON1
- CN Type:** D-sub 15-pin female connector
- CN Location:** See Figure 4-22
- CN Pinouts:** See Figure 4-28 and Table 4-27

The standard 15-pin female VGA connector connects to a CRT or LCD monitor.

Pin	Description	Pin	Description	Pin	Description
1	RED	6	GROUND	11	NC
2	GREEN	7	GROUND	12	SDA
3	BLUE	8	GROUND	13	HSYNC
4	+5V	9	NC	14	VSYNC
5	GROUND	10	GROUND	15	SCL

Table 4-27: VGA Connector Pinouts

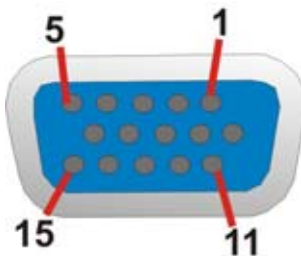

Figure 4-28: VGA Connector

4.4 Jumper Settings



NOTE:

A jumper is a metal bridge that is used to close an electrical circuit. It consists of two metal pins and a small metal clip (often protected by a plastic cover) that slides over the pins to connect them. To CLOSE/SHORT a jumper means connecting the pins of the jumper with the plastic clip and to OPEN a jumper means removing the plastic clip from a jumper.

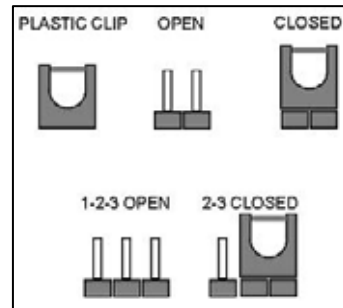

Before the IQ7 Design Guide is installed in the system, the jumpers must be set in accordance with the desired configuration. The jumpers on the IQ7 Design Guide are listed in Table 4-28.

Description	Label	Type
AT/ATX mode selection	JP8 & SW5	6-pin header & switch
Clear CMOS	JP6	3-pin header
CompactFlash® Master/Slave	JP4	3-pin header
CompactFlash® voltage	JP3	3-pin header
LAN & PCIe enable/disable	SW3	Switch
TTL voltage selection	J_VLVDS1	3-pin header
SATA & graphics settings	SW4	Switch
TTL enable/disable	SW5	Switch

Table 4-28: Jumpers

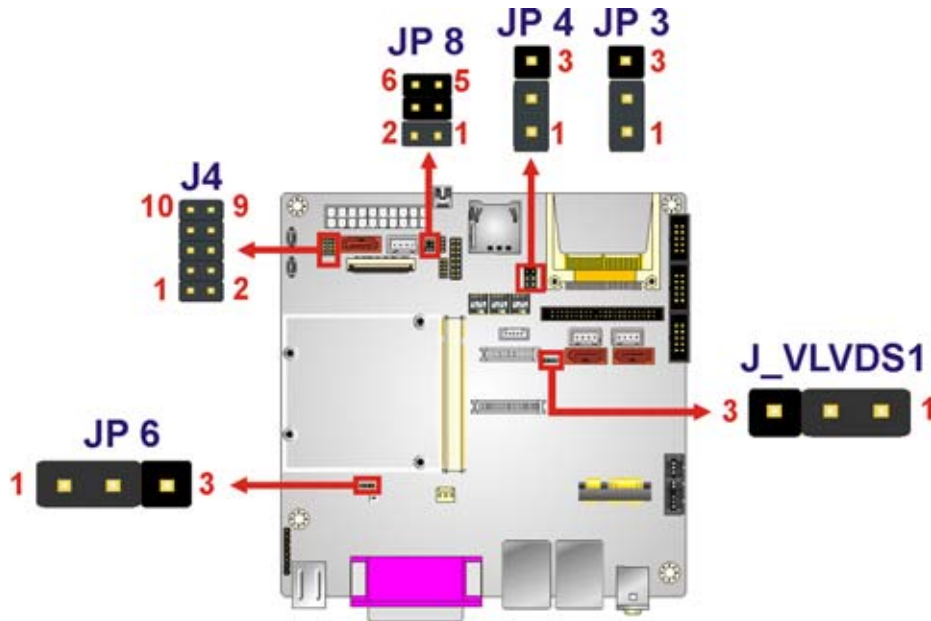

Figure 4–29: Jumpers

4.4.1 AT/ATX Mode Selection

- Jumper Label:** JP8 & SW5
- Jumper Type:** 6-pin header & switch
- Jumper Settings:** See Table 4-29 & Table 4-30
- Jumper Location:** See Figure 4–29

Set both of the jumpers select AT or ATX power mode for the IQ7 Design Guide. AT power mode limits the system to on/off. ATX allows the system to use various power saving states and enter a standby state, so the system can be turned on remotely over a network. The settings on both jumpers should be the same.

JP8	Description
1-2	ATX mode
3-4	AT mode
5-6	No function

Table 4-29: AT/ATX Mode Selection

SW5	Description
1-On	AT mode
1-Off	ATX mode

Table 4-30: AT/ATX Mode Selection

4.4.2 Clear CMOS Jumper

Jumper Label:	JP8
Jumper Type:	3-pin header
Jumper Settings:	See Table 4-31
Jumper Location:	See Figure 4-29

If the IQ7 Design Guide fails to boot due to improper BIOS settings, the clear CMOS jumper clears the CMOS data and resets the system BIOS information. To do this, use the jumper cap to close pins 2 and 3 for a few seconds then reinstall the jumper clip back to pins 1 and 2.

If the “CMOS Settings Wrong” message is displayed during the boot up process, the fault may be corrected by pressing the F1 to enter the CMOS Setup menu. Do one of the following:

- Enter the correct CMOS setting
- Load Optimal Defaults
- Load Failsafe Defaults.

After having done one of the above, save the changes and exit the CMOS Setup menu.

The clear CMOS jumper settings are shown in Table 4-31.

Pin	Description
1-2	Keep CMOS Setup
2-3	Clear CMOS Setup

Table 4-31: Clear CMOS Jumper Settings

4.4.3 CompactFlash® Master/Slave Selection

- Jumper Label:** JP4
- Jumper Type:** 3-pin header
- Jumper Settings:** See Table 4-32
- Jumper Location:** See Figure 4-29

Sets the CompactFlash® slot as the IDE primary master or primary slave.

Pin	Description
1-2	Slave
2-3	Master

Table 4-32: CompactFlash® Master/Slave Selection

4.4.4 CompactFlash® Voltage Selection

- Jumper Label:** JP3
- Jumper Type:** 3-pin header
- Jumper Settings:** See Table 4-33
- Jumper Location:** See Figure 4-29

Sets the voltage of the power supplied to the CompactFlash® card.

Pin	Description
1-2	5.0 V
2-3	3.3 V

Table 4-33: CompactFlash® Voltage Selection

4.4.5 LAN & PCIe Enable/Disable

- Jumper Label:** SW3
- Jumper Type:** 4 switches
- Jumper Settings:** See Table 4-34
- Jumper Location:** See Figure 4-29

These settings enable and disabled these devices on the IQ7 Design Guide.

SW3	Description
1-On & 2-Off	PCIe x1 slot enabled & LAN2 disabled
1-Off & 2-On	LAN2 enabled & PCIe x1 slot disabled
3-On & 4-Off	LAN1 enabled & PCIe Mini card disabled
3-Off & 4-On	PCIe Mini enabled & LAN1 disabled

Table 4-34: LAN & PCIe Enable/Disable

4.4.6 TTL Voltage Selection

- Jumper Label:** J_VLVDS1
- Jumper Type:** 3-pin header
- Jumper Settings:** See Table 4-35
- Jumper Location:** See Figure 4-29

Selects the voltage of the LVDS connector.

Pin	Description
1-2	3.3 V
2-3	5.0 V

Table 4-35: LVDS Voltage Selection

4.4.7 SATA & Graphics Settings

- Jumper Label:** SW4
- Jumper Type:** 4 switches
- Jumper Settings:** See Table 4-36
- Jumper Location:** See Figure 4-29

These settings enable and disabled these devices on the IQ7 Design Guide.

SW4	Description
1-On & 2-Off	SDVO enabled & VGA disabled
1-Off & 2-On	VGA enabled & SDVO disabled

IQ7 Design Guide

SW4	Description
3-On	SATA as master
3-Off	SATA as slave
4-On	SATA disable
4-Off	SATA enabled

Table 4-36: LAN & PCIe Enable/Disable

4.4.8 TTL Enabled/Disable

Jumper Label:	SW5
Jumper Type:	Switch
Jumper Settings:	See Table 4-37
Jumper Location:	See Figure 4-29

Disables/enables the TTL connection.

Pin	Description
2-On	TTL disable
2-Off	TTL enable

Table 4-37: TTL Enable/Disable

Chapter

5

Installation

5.1 Anti-static Precautions



WARNING:

Failure to take ESD precautions during installation may result in permanent damage to the device and severe injury to the user.

Electrostatic discharge (ESD) can cause serious damage to electronic components. Dry climates are especially susceptible to ESD. It is therefore critical to strictly adhere to the following anti-static precautions when any electrical component is handled.

- **Wear an anti-static wristband:** - Wearing a simple anti-static wristband can help to prevent ESD from damaging the board.
- **Self-grounding:** - Before handling the board touch any grounded conducting material. During the time the board is handled, frequently touch any conducting materials that are connected to the ground.
- **Use an anti-static pad:** When configuring, place on an anti-static pad. This reduces the possibility of ESD damage.
- **Only handle the edges of the PCB:-:** When handling the PCB, hold the PCB by the edges.

5.2 Installation Considerations



NOTE:

The following installation notices and installation considerations should be read and understood before installation. All installation notices should be strictly adhered to. Failing to adhere to these precautions may lead to severe damage of the product and injury to the person installing the motherboard.

**WARNING:**

The installation instructions described in this manual should be carefully followed in order to prevent damage to the product, its components and injury to the user.

Before and during the installation please **DO** the following:

- **Read the user manual:**
 - The user manual provides a complete description of the installation instructions and configuration options.
- **Wear an electrostatic discharge cuff (ESD):**
 - Electronic components are easily damaged by ESD. Wearing an ESD cuff removes ESD from the body and helps prevent ESD damage.
- **Place the product on an antistatic pad:**
 - When installing or configuring the motherboard, place it on an antistatic pad. This helps to prevent potential ESD damage.
- **Turn all power to the product off:**
 - When working with the product, make sure that it is disconnected from all power supplies and that no electricity is being fed into the system.

Before and during installation, **DO NOT:**

- **DO NOT** remove any of the stickers on the PCB board. These stickers are required for warranty validation.
- **DO NOT** use the product before verifying all the cables and power connectors are properly connected.
- **DO NOT** allow screws to come in contact with the PCB circuit, connector pins, or its components.

5.3 CPU Module Installation

**WARNING:**

Only install the QSeven CPU module on a compatible QSeven baseboard like the IQ7-DB-MITX. Attempting to force another CPU card to fit can cause permanent damage to the system.

To install the CPU module, refer to Figure 5-1.

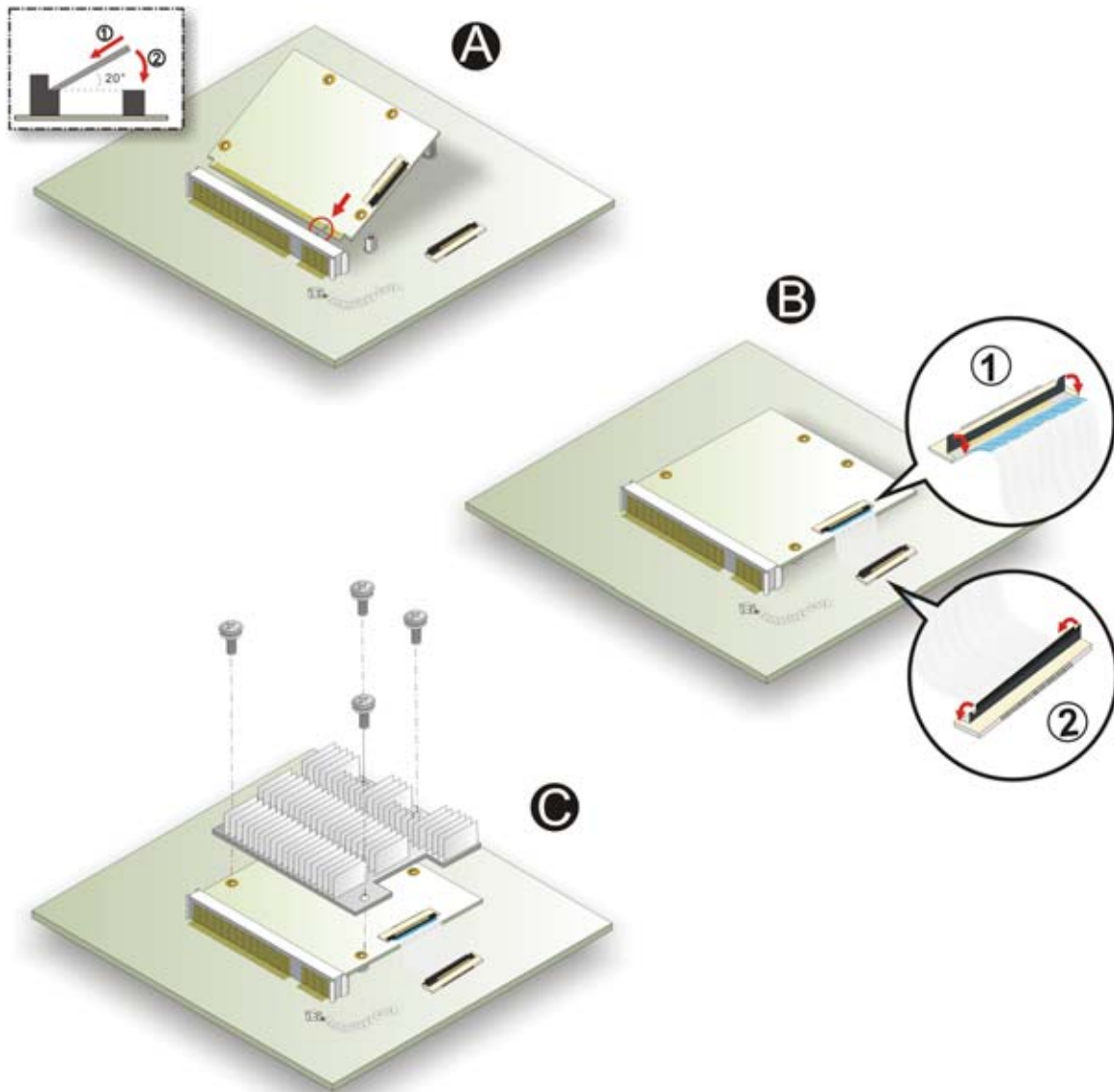

Figure 5-1: Installing the QSeven CPU Module

- Step 1:** Insert the CPU module into the QSeven slot.
- Step 2:** Press down with the heatsink on top.
- Step 3:** Tighten the screws to hold down the CPU card and the heatsink.

Chapter

6

BIOS

6.1 Introduction

The BIOS is programmed onto the BIOS chip. The BIOS setup program allows changes to certain system settings. This chapter outlines the options that can be changed.

6.1.1 Starting Setup

The AMI BIOS is activated when the computer is turned on. The setup program can be activated in one of two ways.

1. Press the **DELETE** key as soon as the system is turned on or
2. Press the **DELETE** key when the “**Press Del to enter SETUP**” message appears on the screen.

If the message disappears before the **DELETE** key is pressed, restart the computer and try again.

6.1.2 Using Setup

Use the arrow keys to highlight items, press **ENTER** to select, use the PageUp and PageDown keys to change entries, press **F1** for help and press **Esc** to quit. Navigation keys are shown in.

Key	Function
Up arrow	Move to previous item
Down arrow	Move to next item
Left arrow	Move to the item on the left hand side
Right arrow	Move to the item on the right hand side
Esc key	Main Menu – Quit and not save changes into CMOS Status Page Setup Menu and Option Page Setup Menu -- Exit current page and return to Main Menu
Page Up key	Increase the numeric value or make changes
Page Dn key	Decrease the numeric value or make changes
F1 key	General help, only for Status Page Setup Menu and Option Page Setup Menu

IQ7 Design Guide

Key	Function
F2 /F3 key	Change color from total 16 colors. F2 to select color forward.
F10 key	Save all the CMOS changes, only for Main Menu

Table 6-1: BIOS Navigation Keys

6.1.3 Getting Help

When **F1** is pressed a small help window describing the appropriate keys to use and the possible selections for the highlighted item appears. To exit the Help Window press **Esc** or the **F1** key again.

6.1.4 Unable to Reboot After Configuration Changes

If the computer cannot boot after changes to the system configuration is made, CMOS defaults. Use the jumper described in Chapter 5.

6.1.5 BIOS Menu Bar

The **menu bar** on top of the BIOS screen has the following main items:

- Main – Changes the basic system configuration.
- Advanced – Changes the advanced system settings.
- PCIPnP – Changes the advanced PCI/PnP Settings
- Boot – Changes the system boot configuration.
- Security – Sets User and Supervisor Passwords.
- Chipset – Changes the chipset settings.
- Power – Changes power management settings.
- Exit – Selects exit options and loads default settings

The following sections completely describe the configuration options found in the menu items at the top of the BIOS screen and listed above.

6.2 Main

The **Main** BIOS menu (BIOS Menu 1) appears when the **BIOS Setup** program is entered. The **Main** menu gives an overview of the basic system information.

```

BIOS SETUP UTILITY
Main  Advanced  PCIPNP  Boot  Security  Chipset  Exit

System Overview
-----
AMIBIOS
Version      :08.00.15
Build Date   :12/18/08
ID:          :B137MR10

Processor
Intel® Atom CPU Z510 @ 1.10 GHz
Speed       :1100MHz
Count       :1

System Memory
Size        :1019MB

System Time      [14:20:27]
System Time      [Tue 05/06/2008]

CMC Lo-Module: 0D2.023x, Hi-Module:0D2.016x

v02.61 ©Copyright 1985-2006, American Megatrends, Inc.

Use [ENTER], [TAB] or [SHIFT-TAB] to select a field.
Use [+] or [-] to configure system time.
←→ Select Screen
↑↓ Select Item
Enter Go to SubScreen
F1  General Help
F10 Save and Exit
ESC Exit
    
```

BIOS Menu 1: Main

- **System Overview**

The **System Overview** lists a brief summary of different system components. The fields in **System Overview** cannot be changed. The items shown in the system overview include:

- AMI BIOS: Displays auto-detected BIOS information
 - **Version:** Current BIOS version
 - **Build Date:** Date the current BIOS version was made
 - **ID:** Installed BIOS ID
- Processor: Displays auto-detected CPU specifications
 - **Type:** Names the currently installed processor
 - **Speed:** Lists the processor speed
 - **Count:** The number of CPUs on the motherboard
- System Memory: Displays the auto-detected system memory.

IQ7 Design Guide

- **Size:** Lists memory size

The System Overview field also has two user configurable fields:

- **System Time [xx:xx:xx]**

Use the **System Time** option to set the system time. Manually enter the hours, minutes and seconds.

- **System Date [xx/xx/xx]**

Use the **System Date** option to set the system date. Manually enter the day, month and year.

6.3 Advanced

Use the **Advanced** menu (BIOS Menu 2) to configure the CPU and peripheral devices through the following sub-menus:

```

BIOS SETUP UTILITY
Main  Advanced  PCIPNP  Boot  Security  Chipset  Exit
-----
Advanced Settings                                Configure CPU
-----
WARNING: Setting wrong values in below sections may cause
system to malfunction

> CPU Configuration
> IDE Configuration
> SuperIO Configuration
> Hardware Health Configuration
> Remote Access Configuration
> USB Configuration

                                  ←→  Select Screen
                                  ↑↓  Select Item
                                  Enter Go to SubScreen
                                  F1   General Help
                                  F10  Save and Exit
                                  ESC  Exit

v02.61 ©Copyright 1985-2006, American Megatrends, Inc.

```

BIOS Menu 2: Advanced

6.3.1 CPU Configuration

Use the **CPU Configuration** menu (BIOS Menu 3) to view detailed CPU specifications and configure the CPU.

```

BIOS SETUP UTILITY
Main  Advanced  PCIPNP  Boot  Security  Chipset  Exit
-----
Configure Advanced CPU Settings
Module Version:3F.14
-----
Manufacturer  :Intel@
Intel@ Atom CPU Z510 @ 1.10 GHz
Frequency     :1.10GHz
FSB Speed     :400Hz

Cache L1      :24 KB
Cache L2      :512 KB

Ratio Actual Value:11

<=> Select Screen
↑↓ Select Item
Enter Go to SubScreen
F1 General Help
F10 Save and Exit
ESC Exit

v02.61 ©Copyright 1985-2006, American Megatrends, Inc.

```

BIOS Menu 3: CPU Configuration

The CPU Configuration menu (BIOS Menu 3) lists the following CPU details:

- Manufacturer: Lists the name of the CPU manufacturer
- Brand String: Lists the brand name of the CPU being used
- Frequency: Lists the CPU processing speed
- FSB Speed: Lists the FSB speed
- Cache L1: Lists the CPU L1 cache size
- Cache L2: Lists the CPU L2 cache size
- Ratio actual value is the ratio of the frequency to the clock speed

IQ7 Design Guide

6.3.2 IDE Configuration

Use the **IDE Configuration** menu (BIOS Menu 4) to change and/or set the configuration of the IDE devices installed in the system.

```

BIOS SETUP UTILITY
Main  Advanced  PCIPNP  Boot  Security  Chipset  Exit
-----
IDE Configuration
-----
Onboard PCI IDE Controller      [Primary]      Primary
                                :                Disabled
> Primary IDE Master           : [Not Detected]
> Primary IDE Slave            : [Not Detected]

<=>  Select Screen
↑↓   Select Item
Enter Go to SubScreen
F1   General Help
F10  Save and Exit
ESC  Exit

v02.61 ©Copyright 1985-2006, American Megatrends, Inc.

```

BIOS Menu 4: IDE Configuration

- **Onboard PCI IDE Controller [Primary]**

Use the **Onboard PCI IDE Controller** to configure the IDE channel.

- ➔ **Primary** DEFAULT IDE drives are enabled
- ➔ **Disabled** IDE drives disabled

- **IDE Master and IDE Slave**

When entering setup, BIOS auto detects the presence of IDE devices. BIOS displays the status of the auto detected IDE devices. The following IDE devices are detected and are shown in the **IDE Configuration** menu:

- Primary IDE Master
- Primary IDE Slave

6.3.2.1 IDE Master, IDE Slave

Use the **IDE Master** and **IDE Slave** configuration menu to view both primary and secondary IDE device details and configure the IDE devices connected to the system.

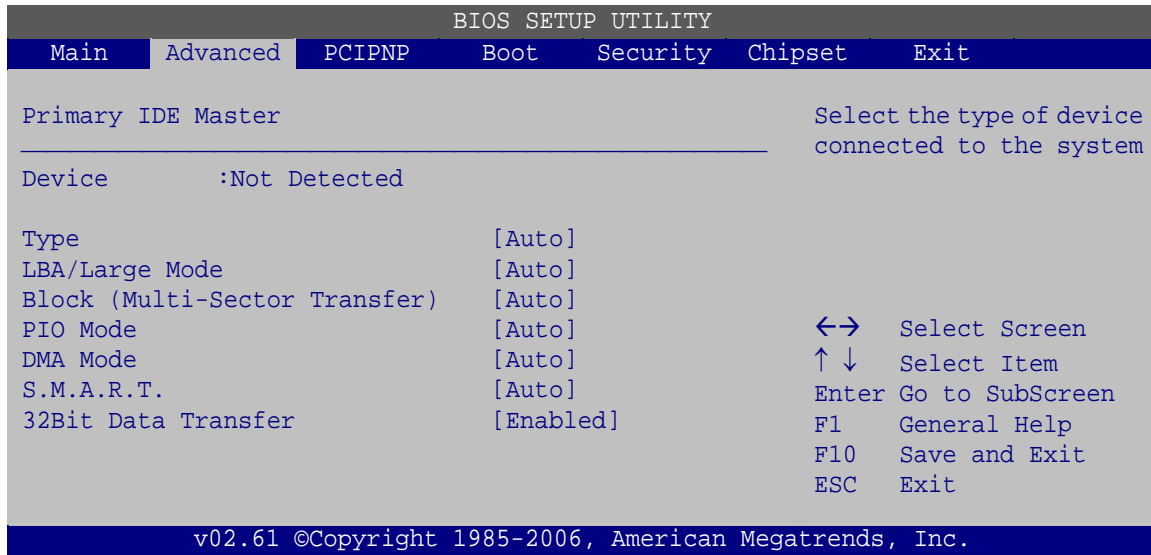

BIOS Menu 5: IDE Master and IDE Slave Configuration

- **Auto-Detected Drive Parameters**

The “grayed-out” items in the left frame are IDE disk drive parameters automatically detected from the firmware of the selected IDE disk drive. The drive parameters are listed as follows:

- **Device:** Lists the device type (e.g. hard disk, CD-ROM etc.)
- **Type:** Indicates the type of devices a user can manually select
- **Vendor:** Lists the device manufacturer
- **Size:** List the storage capacity of the device.
- **LBA Mode:** Indicates whether the LBA (Logical Block Addressing) is a method of addressing data on a disk drive is supported or not.
- **Block Mode:** Block mode boosts IDE drive performance by increasing the amount of data transferred. Only 512 bytes of data can be transferred per interrupt if block mode is not used. Block mode allows transfers of up to 64 KB per interrupt.
- **PIO Mode:** Indicates the PIO mode of the installed device.

IQ7 Design Guide

- Async DMA: Indicates the highest Asynchronous DMA Mode that is supported.
 - Ultra DMA: Indicates the highest Synchronous DMA Mode that is supported.
 - S.M.A.R.T.: Indicates whether or not the Self-Monitoring Analysis and Reporting Technology protocol is supported.
 - 32Bit Data Transfer: Enables 32-bit data transfer.
- **Type [Auto]**

Use the **Type** BIOS option select the type of device the AMIBIOS attempts to boot from after the Power-On Self-Test (POST) is complete.

- ➔ **Not Installed** BIOS is prevented from searching for an IDE disk drive on the specified channel.
- ➔ **Auto** **DEFAULT** The BIOS auto detects the IDE disk drive type attached to the specified channel. This setting should be used if an IDE hard disk drive is attached to the specified channel.
- ➔ **CD/DVD** The CD/DVD option specifies that an IDE CD-ROM drive is attached to the specified IDE channel. The BIOS does not attempt to search for other types of IDE disk drives on the specified channel.
- ➔ **ARMD** This option specifies an ATAPI Removable Media Device. These include, but are not limited to:
ZIP
LS-120

- **LBA/Large Mode [Auto]**

Use the **LBA/Large Mode** option to disable or enable BIOS to auto detects LBA (Logical Block Addressing). LBA is a method of addressing data on a disk drive. In LBA mode, the maximum drive capacity is 137 GB.

- ➔ **Disabled** BIOS is prevented from using the LBA mode control on the specified channel.

➔ **Auto** **DEFAULT** BIOS auto detects the LBA mode control on the specified channel.

▪ **Block (Multi Sector Transfer) [Auto]**

Use the **Block (Multi Sector Transfer)** to disable or enable BIOS to auto detect if the device supports multi-sector transfers.

➔ **Disabled** BIOS is prevented from using Multi-Sector Transfer on the specified channel. The data to and from the device occurs one sector at a time.

➔ **Auto** **DEFAULT** BIOS auto detects Multi-Sector Transfer support on the drive on the specified channel. If supported the data transfer to and from the device occurs multiple sectors at a time.

▪ **PIO Mode [Auto]**

Use the **PIO Mode** option to select the IDE PIO (Programmable I/O) mode program timing cycles between the IDE drive and the programmable IDE controller. As the PIO mode increases, the cycle time decreases.

➔ **Auto** **DEFAULT** BIOS auto detects the PIO mode. Use this value if the IDE disk drive support cannot be determined.

➔ **0** PIO mode 0 selected with a maximum transfer rate of 3.3 MB/s

➔ **1** PIO mode 1 selected with a maximum transfer rate of 5.2 MB/s

➔ **2** PIO mode 2 selected with a maximum transfer rate of 8.3 MB/s

➔ **3** PIO mode 3 selected with a maximum transfer rate of 11.1 MB/s

➔ **4** PIO mode 4 selected with a maximum transfer rate of 16.6 MB/s
(This setting generally works with all hard disk drives manufactured after 1999. For other disk drives, such as IDE CD-ROM drives, check the specifications of the drive.)

IQ7 Design Guide

- **DMA Mode [Auto]**

Use the **DMA Mode** BIOS selection to adjust the DMA mode options.

- ➔ **Auto** **DEFAULT** BIOS auto detects the DMA mode. Use this value if the IDE disk drive support cannot be determined.
- ➔ **SWDMA0** Single Word DMA mode 0, max transfer rate: 2.1 MB/s
- ➔ **SWDMA1** Single Word DMA mode 1, max transfer rate: 4.2 MB/s
- ➔ **SWDMA2** Single Word DMA mode 2, max transfer rate: 8.3 MB/s
- ➔ **MWDMA0** Multi Word DMA mode 0, max transfer rate: 4.2 MB/s
- ➔ **MWDMA1** Multi Word DMA mode 1, max transfer rate: 13.3 MB/s
- ➔ **MWDMA2** Multi Word DMA mode 2, max transfer rate: 16.6 MB/s
- ➔ **UDMA0** Ultra DMA mode 0, max transfer rate: 16.6 MB/s
- ➔ **UDMA1** Ultra DMA mode 1, max transfer rate: 25 MB/s
- ➔ **UDMA2** Ultra DMA mode 2, max transfer rate: 33.3 MB/s
- ➔ **UDMA3** Ultra DMA mode 3, max transfer rate: 44 MB/s (To use this mode, it is required that an 80-conductor ATA cable is used.)
- ➔ **UDMA4** Ultra DMA mode 4, max transfer rate: 66.6 MB/s (To use this mode, it is required that an 80-conductor ATA cable is used.)
- ➔ **UDMA5** Ultra DMA mode 5, max transfer rate: 99.9 MB/s (To use this mode, it is required that an 80-conductor ATA cable is used.)

- **S.M.A.R.T [Auto]**

Use the **S.M.A.R.T** option to auto-detect, disable or enable Self-Monitoring Analysis and Reporting Technology (SMART) on the drive on the specified channel. **S.M.A.R.T** predicts impending drive failures. The **S.M.A.R.T** BIOS option enables or disables this function.

- ➔ **Auto** **DEFAULT** BIOS auto detects HDD SMART support.
- ➔ **Disabled** Prevents BIOS from using the HDD SMART feature.
- ➔ **Enabled** Allows BIOS to use the HDD SMART feature

- **32Bit Data Transfer [Enabled]**

Use the **32Bit Data Transfer** BIOS option to enables or disable 32-bit data transfers.

- ➔ **Disabled** Prevents the BIOS from using 32-bit data transfers.
- ➔ **Enabled** **DEFAULT** Allows BIOS to use 32-bit data transfers on supported hard disk drives.

6.3.3 Super IO Configuration

Use the **Super IO Configuration** menu (BIOS Menu 6) to set or change the configurations for the FDD controllers, parallel ports and serial ports.

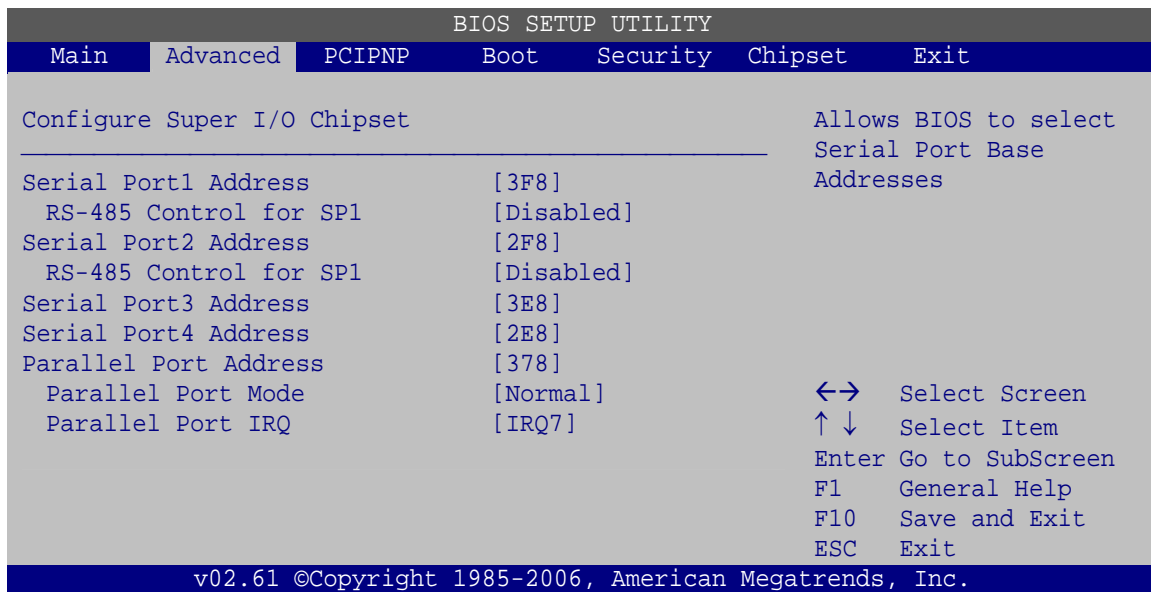

BIOS Menu 6: Super IO Configuration

- **Serial Port1 Address [3F8]**

Use the **Serial Port1 Address** option to select the Serial Port 1 base address.

- ➔ **Disabled** No base address is assigned to Serial Port 1
- ➔ **3F8** **DEFAULT** I/O port address is 3F8
- ➔ **3E8** I/O port address is 3E8
- ➔ **2E8** I/O port address is 2E8

IQ7 Design Guide

- **RS-485 Control for SP1 [Disabled]**

This feature enables Automatic Send Data Control when using the RS-485 communication protocol. This setting is important for half duplex 2-wire operation and can lead to data loss if disabled.

- Disabled **DEFAULT**
- Enabled

- **Serial Port2 Address [2F8]**

Use the **Serial Port2 Address** option to select the Serial Port 2 base address.

- ➔ **Disabled** No base address is assigned to Serial Port 2
- ➔ **2F8** **DEFAULT** I/O port address is 3F8
- ➔ **3E8** I/O port address is 3E8
- ➔ **2E8** I/O port address is 2E8

- **RS-485 Control for SP2 [Disabled]**

This feature enables Automatic Send Data Control when using the RS-485 communication protocol. This setting is important for half duplex 2-wire operation and can lead to data loss if disabled.

- Disabled **DEFAULT**
- Enabled

- **Serial Port3 Address [3E8]**

Use the **Serial Port3 Address** option to select the base addresses for serial port 3

- ➔ **Disabled** No base address is assigned to serial port 3
- ➔ **3F8** Serial port 3 I/O port address is 3F8
- ➔ **2F8** Serial port 3 I/O port address is 2F8
- ➔ **3E8** **DEFAULT** Serial port 3 I/O port address is 3E8
- ➔ **2E8** Serial port 3 I/O port address is 2E8

- **Serial Port4 Address [2E8]**

Use the **Serial Port4 IRQ** option to select the interrupt address for serial port 4.

- ➔ **Disabled** No base address is assigned to serial port 4
- ➔ **3F8** Serial port 4 I/O port address is 3F8
- ➔ **2F8** Serial port 4 I/O port address is 2F8
- ➔ **3E8** Serial port 4 I/O port address is 3E8
- ➔ **2E8** **DEFAULT** Serial port 4 I/O port address is 2E8

- **Parallel Port Address [378]**

Use the **Parallel Port Address** option to select the parallel port base address.

- ➔ **Disabled** No base address is assigned to the Parallel Port
- ➔ **378** **DEFAULT** Parallel Port I/O port address is 378
- ➔ **278** Parallel Port I/O port address is 278
- ➔ **3BC** Parallel Port I/O port address is 3BC

- **Parallel Port Mode [Normal]**

Use the **Parallel Port Mode** option to select the mode the parallel port operates in.

- ➔ **Normal** **DEFAULT** The normal parallel port mode is the standard mode for parallel port operation.
- ➔ **Bi-directional** Parallel port outputs are 8-bits long. Inputs are accomplished by reading 4 of the 8 bits on the status register.
- ➔ **EPP** The parallel port operates in the enhanced parallel port mode (EPP). The EPP mode supports bi-directional communication between the system and the parallel port device and the transmission rates between the two are much faster than the Normal mode.

IQ7 Design Guide

➔ ECP+EPP

The parallel port operates in the extended capabilities port (ECP) mode. The ECP mode supports bi-directional communication between the system and the parallel port device and the transmission rates between the two are much faster than the Normal mode

The parallel port is also be compatible with EPP devices described above

▪ Parallel Port IRQ [IRQ7]

Use the **Parallel Port IRQ** selection to set the parallel port interrupt address.

➔ **IRQ5** IRQ5 is assigned as the parallel port interrupt address

➔ **IRQ7** **DEFAULT** IRQ7 is assigned as the parallel port interrupt address

6.3.4 Hardware Health Configuration

The **Hardware Health Configuration** menu (BIOS Menu 7) shows the operating temperature, fan speeds and system voltages.

```

BIOS SETUP UTILITY
Main  Advanced  PCIPNP  Boot  Security  Chipset  Exit
-----
Hardware Health Event Monitoring
-----
SYS 1 FAN Mode Setting          [Thermal Mode]      Manual Mode
TargetTemp Value                [030]                Thermal Mode
Tolerance Value                  [05]
Startup Value                    [050]
Stop Value                       [50]
StopTime Value                   [001]
SYS 1 FAN PWM Control           [255]

CPU Temperature                  :54°C/129°F
SYS 1 Temperature                :44°C/111°F
SYS 2 Temperature                :54°C/129°F

SYS 1 FAN Speed                  :N/A

Vcore                            :0.976 V
+3.3V                            :3.376 V
VBAT                             :2.861 V
VCC                              :5.130 V
SMSC 3114 HARDWARE MONITOR
+1.5V                            :1.497 V
+5V                              :5.048 V

←→  Select Screen
↑↓  Select Item
Enter Go to SubScreen
F1   General Help
F10  Save and Exit
ESC  Exit

v02.61 ©Copyright 1985-2006, American Megatrends, Inc.

```

BIOS Menu 7: Hardware Health Configuration

- **Mode Setting [Full On Mode]**

Use the **Mode Setting** option to configure the second fan.

IQ7 Design Guide

→ Thermal Mode

The fan adjusts its speed using these settings:

TargetTemp Value

Tolerance Value

Startup Value

Stop Value

StopTime Value

→ Manual Mode

DEFAULT

The fan spins at the set speed, max speed is at 255, full-off is at 0.

▪ TargetTemp [030]



WARNING:

CPU failure can result if this value is set too high

The fan will turn off if the temperature falls below this value.

- Minimum Value: 0°C
- Maximum Value: 127°C

▪ Tolerance Value [05]

This options sets how fine the jumps in fan speed are. If the setting is low, the fan will change speed in small increments, if the value is larger it will change speed in big amounts.

- Min: 0
- Max: 15

- **StartUp Value [050]**

**WARNING:**

CPU failure can result if this value is set too high

This is the initial speed of the fan when it first starts spinning.

- Minimum: 0
- Maximum: 127

- **Stop Value [50]**

The fan will be turned off when the PWM speed value falls below this setting. When the fan gets this slow, it will just turn off.

- Minimum: 0
- Maximum: 255

- **StopTime Value [001]**

Specifies how long it takes for the fan to shut down after it reaches the shut down setting. This setting is measured in split-seconds (0.1 s).

- Minimum: 0
- Maximum: 255

6.3.5 AHCI Configuration

Use the **AHCI Settings** menu (BIOS Menu 8) to report on the auto-detection of devices connected to the onboard SATA drive connectors.

```

BIOS SETUP UTILITY
Main  Advanced  PCIPNP  Boot  Security  Chipset  Exit
-----
AHCI Settings
-----
AHCI CD/DVD Boot Time out      [15]
-----
> AHCI Port0 [Not Detected]
> AHCI Port1 [Not Detected]
> AHCI Port2 [Not Detected]
> AHCI Port3 [Not Detected]
> AHCI Port4 [Not Detected]
> AHCI Port5 [Not Detected]

Some SATA CD/DVD in AHCI
mode need to wait ready
longer

<->  Select Screen
↑↓   Select Item
Enter Go to SubScreen
F1   General Help
F10  Save and Exit
ESC  Exit

v02.61 ©Copyright 1985-2006, American Megatrends, Inc.

```

BIOS Menu 8: AHCI Configuration

- **AHCI Port n [Not Detected]**

Use the **AHCI Port n** BIOS option to check what AHCI (Advanced Host Controller Interface) devices are detected to a specified SATA drive connector. If a device is detected, selecting the BIOS option, e.g. “**AHCI Port 3**” opens a new window.

6.3.5.1 AHCI Port n

Use the **AHCI Port n** configuration menu (BIOS Menu 9) to configure the drive connected to SATA connector n.

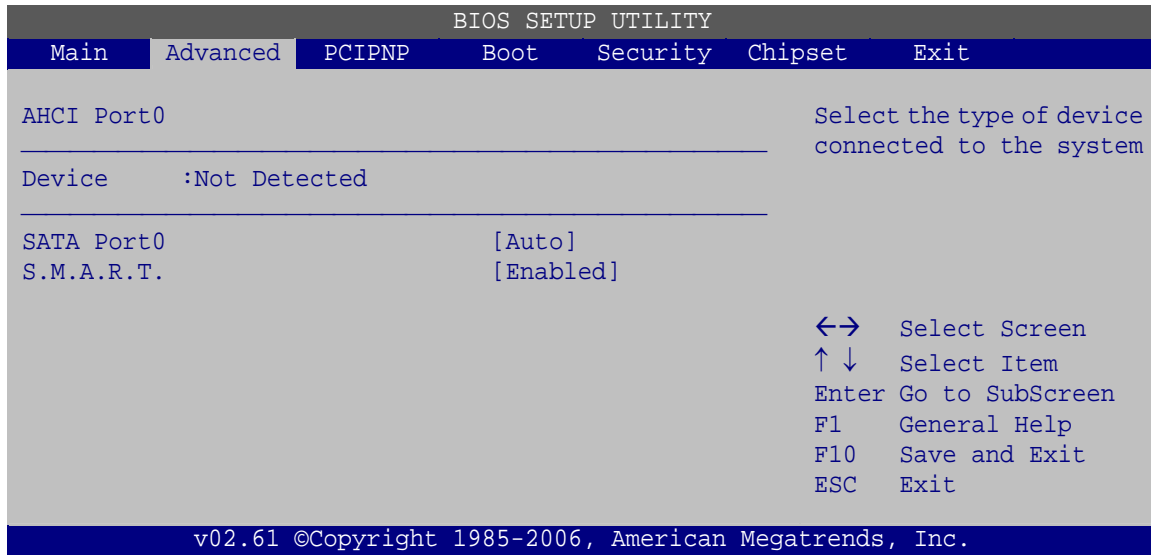

BIOS Menu 9: AHCI Port n Configuration Menu

- **SATA Port n [Auto]**

Use the **SATA Port n** option to enable the system to auto-detect the type of drive connected to SATA drive connector n.

- **S.M.A.R.T [Enabled]**

Use the **S.M.A.R.T** option to enable S.M.A.R.T (Self-Monitoring, Analysis, and Reporting Technology) on the drive connected to SATA drive connector n.

➔ **Enabled** **DEFAULT** S.M.A.R.T is enabled on the drive connected to SATA drive connector n on the system

➔ **Disabled** S.M.A.R.T is disabled on the drive connected to SATA drive connector n on the system

IQ7 Design Guide

6.3.6 Intel AMT Configuration

Use the **Intel AMT** menu (BIOS Menu 10) to enable the system to be managed through the Intel® Active Management Technology (AMT) interface.

```

BIOS SETUP UTILITY
Main  Advanced  PCIPNP  Boot  Security  Chipset  Exit
-----
Configure Intel® AMT Parameters          Options
-----
Intel® AMT Support          [Disabled]  Disabled
                             Enabled
> ME Subsystem Configuration

                                  ←→  Select Screen
                                  ↑↓  Select Item
                                  Enter Go to SubScreen
                                  F1   General Help
                                  F10  Save and Exit
                                  ESC  Exit

v02.61 ©Copyright 1985-2006, American Megatrends, Inc.

```

BIOS Menu 10: Intel AMT Configuration

- **Intel AMT Support**

Use the **Intel AMT Support** option to enable or disable Intel AMT on the system.

- ➔ **Disabled** **DEFAULT** Intel AMT disabled
- ➔ **Enabled** Intel AMT enabled

6.3.6.1 ME Subsystem Configuration

Use the **ME Subsystem Configuration** menu (BIOS Menu 11) to configure the Intel® Management Engine (ME) configuration options.

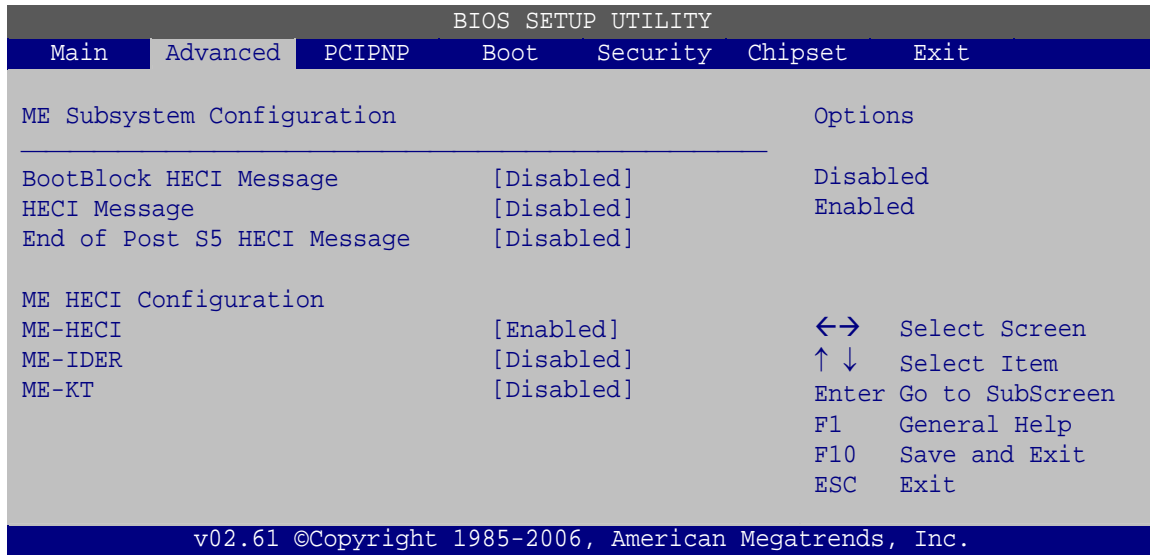

BIOS Menu 11: ME Subsystem Configuration

- **BootBlock HECI Message**

Use the **BootBlock HECI Message** option to enable or disable boot disk sector that contains the Intel® AMT Host-Embedded Controller Interface (HECI) message.

- ➔ **Disabled** **DEFAULT** Boot sector disabled
- ➔ **Enabled** Boot sector enabled

- **HECI Message [Enabled]**

Use the **HECI Message** option to enable or disable the Intel® AMT Host-Embedded Controller Interface (HECI) message.

- ➔ **Disabled** **DEFAULT** HECI message disabled
- ➔ **Enabled** HECI message enabled

IQ7 Design Guide

- **End of Post S5 HECI Message [Enabled]**

Use the **End of Post S5 HECI Message** option to enable or disable the Intel® AMT the HECI message to wake the system in an S5 sleep state.

- ➔ **Disabled** **DEFAULT** HECI bus cannot rouse system from an S5 state
- ➔ **Enabled** HECI bus can rouse system from an S5 state

- **ME-HECI [Enabled]**

This option is not user configurable.

- **ME-IDER [Enabled]**

Use the **ME-IDER** option to enable or disable the IDE-Redirection (IDER) protocol to enable the Intel® AMT enabled product to boot from an OS image, floppy, CD or a DVD device.

- ➔ **Disabled** **DEFAULT** The IDER protocol is disabled
- ➔ **Enabled** The IDER protocol is enabled

- **ME-KT [Enabled]**

Use the **ME-KT** option to enable or disable the Serial Over LAN (SOL) protocol to enable the Intel® AMT enabled product to redirect the keyboard/text from a local host to a remote workstation.

- ➔ **Disabled** **DEFAULT** The SOL protocol is disabled
- ➔ **Enabled** The SOL protocol is enabled

6.3.7 Remote Access Configuration

Use the **Remote Access Configuration** menu (BIOS Menu 12) to configure remote access parameters. The **Remote Access Configuration** is an AMIBIOS feature and allows a remote host running a terminal program to display and configure the BIOS settings.

```

BIOS SETUP UTILITY
Main  Advanced  PCIPNP  Boot  Security  Chipset  Exit
-----
Configure Remote Access type and parameters
-----
Remote Access                [Disabled]
Serial port number           [COM1]
  Base Address, IRQ          [3F8H, 4]
Serial Port Mode             [115200 8,n,1]
Redirection After BIOS POST [Always]
Terminal Type                [ANSI]

                                  ←→  Select Screen
                                  ↑↓  Select Item
                                  Enter Go to SubScreen
                                  F1   General Help
                                  F10  Save and Exit
                                  ESC  Exit

v02.61 ©Copyright 1985-2006, American Megatrends, Inc.

```

BIOS Menu 12: Remote Access Configuration

- **Remote Access [Disabled]**

Use the **Remote Access** option to enable or disable access to the remote functionalities of the system.

- ➔ **Disabled** **DEFAULT** Remote access is disabled.
- ➔ **Enabled** Remote access configuration options shown below appear:
 - Serial Port Number
 - Serial Port Mode
 - Redirection after BIOS POST
 - Terminal Type

These configuration options are discussed below.

IQ7 Design Guide

- **Serial Port Number [COM1]**

Use the **Serial Port Number** option allows to select the serial port used for remote access.

- COM1 **DEFAULT**
- COM2
- COM3
- COM4
- COM5
- COM6

- **Base Address, IRQ [3F8h,4]**

The **Base Address, IRQ** option cannot be configured and only shows the interrupt address of the serial port listed above.

- **Serial Port Mode [115200 8,n,1]**

Use the **Serial Port Mode** option to select baud rate through which the console redirection is made. The following configuration options are available

- 115200 8,n,1 **DEFAULT**
- 57600 8,n,1
- 38400 8,n,1
- 19200 8,n,1
- 09600 8,n,1



NOTE:

Identical baud rate setting must be set on the host (a management computer running a terminal software) and the slave

- **Redirection After BIOS POST [Always]**

Use the **Redirection After BIOS POST** option to specify when console redirection should occur.

- ➔ **Disabled** The console is not redirected after POST
- ➔ **Boot Loader** Redirection is active during POST and during Boot Loader
- ➔ **Always** **DEFAULT** Redirection is always active (Some Oses may not work if set to Always)

▪ **Terminal Type [ANSI]**

Use the **Terminal Type** BIOS option to specify the remote terminal type.

- ➔ **ANSI** **DEFAULT** The target terminal type is ANSI
- ➔ **VT100** The target terminal type is VT100
- ➔ **VT-UTF8** The target terminal type is VT-UTF8

6.3.8 USB Configuration

Use the **USB Configuration** menu (BIOS Menu 13) to read USB configuration information and configure the USB settings.

```

BIOS SETUP UTILITY
Main  Advanced  PCIPNP  Boot  Security  Chipset  Exit
-----
USB Configuration                               Options
-----
Module Version - 2.24.3-13.4                     Disabled
8 USB Ports
USB Devices Enabled:                             Enabled
  1 Keyboard, 1 Mouse

USB Function                                     [Enabled]      ←→ Select Screen
USB 2.0 Controller                             [Enabled]      ↑↓ Select Item
Legacy USB Support                             [Enabled]      Enter Go to SubScreen
USB 2.0 Controller Mode                         [HiSpeed]
> USB Mass Storage Device Configuration          F1 General Help
                                                F10 Save and Exit
                                                ESC Exit

v02.61 ©Copyright 1985-2006, American Megatrends, Inc.

```

BIOS Menu 13: USB Configuration

IQ7 Design Guide

- **Onboard SiS USB1.1 DEVICE [Enabled]**

Use the Onboard **SiS USB1.1 DEVICE** BIOS option to enable or disable the onboard SiS USB1.1 controller. If disabled, USB1.1 devices cannot be used.

- ➔ **Disabled** USB 1.1 interface is disabled and cannot be used.
- ➔ **Enabled** **DEFAULT** USB 1.1 interface is enabled and can be used.

- **Onboard SiS USB2.0 DEVICE [Enabled]**

Use the **Onboard SiS USB2.0 DEVICE** option to enable or disable the onboard SiS USB2.0 controller. If disabled, USB2.0 devices cannot be used.

- ➔ **Disabled** USB 2.0 interface is disabled and cannot be used.
- ➔ **Enabled** **DEFAULT** USB 2.0 interface is enabled and can be used.

- **USB Configuration**

The **USB Configuration** field shows the system USB configuration. The items listed are:

- Module Version: x.xxxxx.xxxxx

- **USB Devices Enabled**

The **USB Devices Enabled** field lists the USB devices that are enabled on the system

- **USB Functions [Enabled]**

Use the **USB Functions** to enable and disabled the USB ports.

- ➔ **Disabled** USB ports disabled
- ➔ **USB 8 ports** Only the USB ports on the rear I/O panel are activated
- ➔ **Enabled** **DEFAULT** All the USB ports are enabled

- **USB 2.0 Controller [Enabled]**

Use the **USB 2.0 Controller** BIOS option to enable or disable the USB 2.0 controller

- ➔ **Disabled** USB 2.0 controller disabled
- ➔ **Enabled** **DEFAULT** USB 2.0 controller enabled

▪ **Legacy USB Support [Enabled]**

Use the **Legacy USB Support** BIOS option to enable USB mouse and USB keyboard support.

Normally if this option is not enabled, any attached USB mouse or USB keyboard does not become available until a USB compatible operating system is fully booted with all USB drivers loaded. When this option is enabled, any attached USB mouse or USB keyboard can control the system even when there is no USB driver loaded onto the system.

- ➔ **Disabled** Legacy USB support disabled
- ➔ **Enabled** **DEFAULT** Legacy USB support enabled
- ➔ **Auto** Legacy USB support disabled if no USB devices are connected

▪ **USB2.0 Controller Mode [HiSpeed]**

Use the **USB2.0 Controller Mode** option to set the speed of the USB2.0 controller.

- ➔ **FullSpeed** The controller is capable of operating at 12 Mb/s
- ➔ **HiSpeed** **DEFAULT** The controller is capable of operating at 480 Mb/s

6.3.8.1 USB Mass Storage Device Configuration

Use the **USB Mass Storage Device Configuration** menu (BIOS Menu 14) to configure USB mass storage class devices.

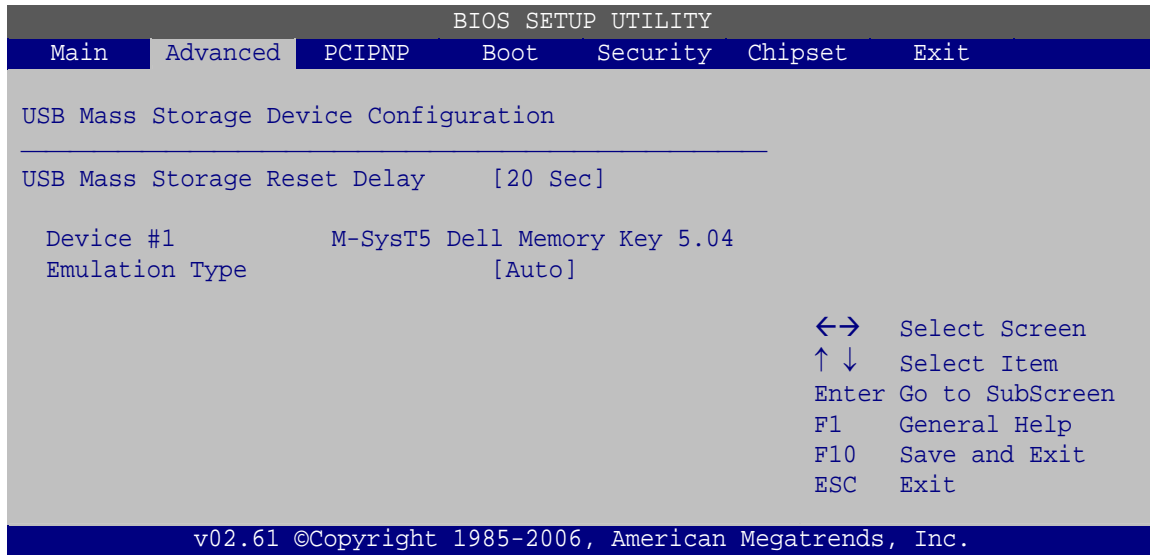

BIOS Menu 14: USB Mass Storage Device Configuration

- **USB Mass Storage Reset Delay [20 Sec]**

Use the **USB Mass Storage Reset Delay** option to set the number of seconds POST waits for the USB mass storage device after the start unit command.

- ➔ **10 Sec** POST waits 10 seconds for the USB mass storage device after the start unit command.
- ➔ **20 Sec** **DEFAULT** POST waits 20 seconds for the USB mass storage device after the start unit command.
- ➔ **30 Sec** POST waits 30 seconds for the USB mass storage device after the start unit command.
- ➔ **40 Sec** POST waits 40 seconds for the USB mass storage device after the start unit command.

- **Device ##**

The **Device##** field lists the USB devices that are connected to the system.

- **Emulation Type [Auto]**

Use the **Emulation Type** BIOS option to specify the type of emulation BIOS has to provide for the USB device.

- ➔ **Auto** **DEFAULT** BIOS auto-detects the current USB.
- ➔ **Floppy** The USB device will be emulated as a floppy drive. The device can be either A: or B: responding to INT13h calls that return DL = 0 or DL = 1 respectively.
- ➔ **Forced FDD** Allows a hard disk image to be connected as a floppy image. This option works only for drives formatted with FAT12, FAT16 or FAT32.
- ➔ **Hard Disk** Allows the USB device to be emulated as hard disk responding to INT13h calls that return DL values of 80h or above.
- ➔ **CDROM** Assumes the CD-ROM is formatted as bootable media. All the devices that support block sizes greater than 512 bytes can only be booted using this option.

6.4 PCI/PnP

Use the **PCI/PnP** menu (BIOS Menu 15) to configure advanced PCI and PnP settings.

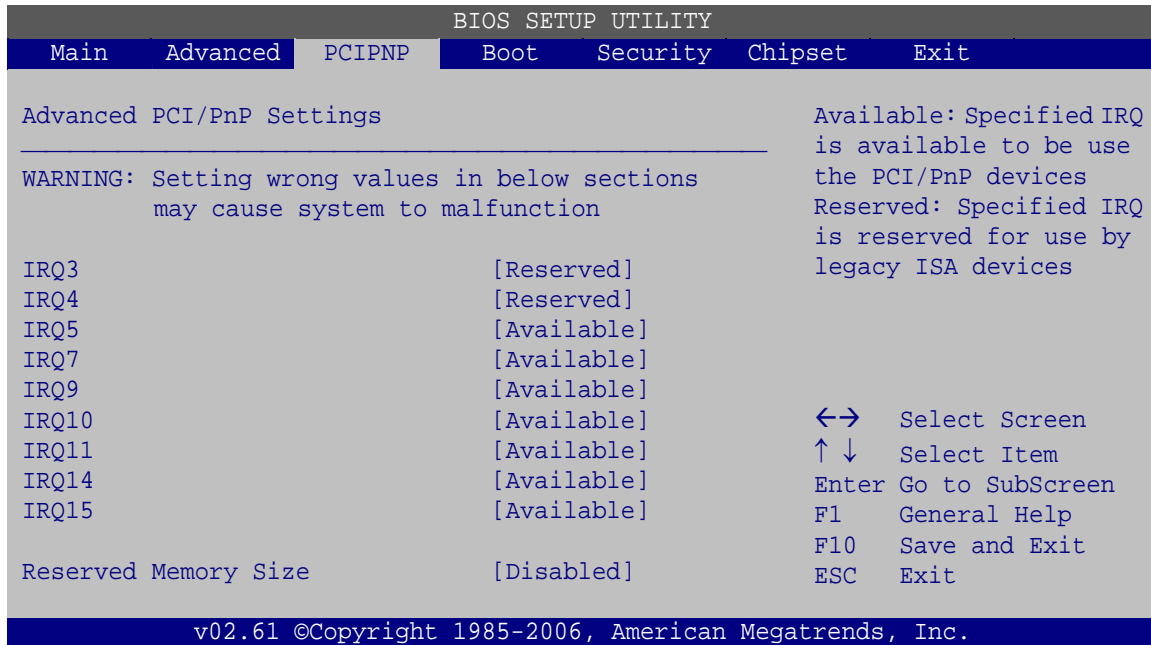

BIOS Menu 15: PCI/PnP Configuration

- **IRQ# [Available]**

Use the **IRQ#** address to specify what IRQs can be assigned to a particular peripheral device.

- ➔ **Available** **DEFAULT** The specified IRQ is available to be used by PCI/PnP devices
- ➔ **Reserved** The specified IRQ is reserved for use by Legacy ISA devices

- **Reserved Memory Size [Disabled]**

Use the **Reserved Memory Size** BIOS option to specify the amount of memory that should be reserved for legacy ISA devices.

- ➔ **Disabled** **DEFAULT** No memory block reserved for legacy ISA devices

- ➔ **16K** 16 KB reserved for legacy ISA devices
- ➔ **32K** 32 KB reserved for legacy ISA devices
- ➔ **64K** 64 KB reserved for legacy ISA devices

6.5 Boot

Use the **Boot** menu (BIOS Menu 16) to configure system boot options.

```

BIOS SETUP UTILITY
Main  Advanced  PCIPNP  Boot  Security  Chipset  Exit
-----
Boot Settings          Configure settings
                       during system boot.
-----
> Boot Settings Configuration

> Boot Device Priority
> Hard Disk Drives
> CD/DVD Drives
> Removable Drives

<->  Select Screen
↑↓   Select Item
Enter Go to SubScreen
F1   General Help
F10  Save and Exit
ESC  Exit

v02.61 ©Copyright 1985-2006, American Megatrends, Inc.

```

BIOS Menu 16: Boot

IQ7 Design Guide

6.5.1 Boot Settings Configuration

Use the **Boot Settings Configuration** menu (BIOS Menu 17) to configure advanced system boot options.

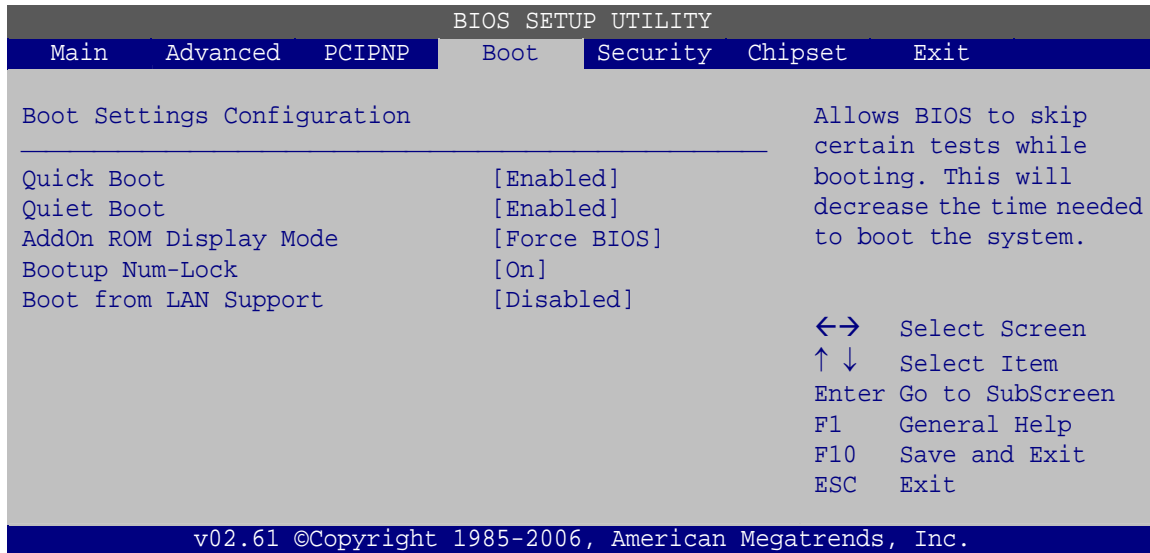

BIOS Menu 17: Boot Settings Configuration

- **Quick Boot [Enabled]**

Use the **Quick Boot** BIOS option to make the computer speed up the boot process.

- ➔ **Disabled** No POST procedures are skipped
- ➔ **Enabled DEFAULT** Some POST procedures are skipped to decrease the system boot time

- **Quiet Boot [Disabled]**

Use the **Quiet Boot** BIOS option to select the screen display when the system boots.

- ➔ **Disabled DEFAULT** Normal POST messages displayed
- ➔ **Enabled** OEM Logo displayed instead of POST messages

- **AddOn ROM Display Mode [Force BIOS]**

Use the **AddOn ROM Display Mode** option to allow add-on ROM (read-only memory) messages to be displayed.

- ➔ **Force BIOS** **DEFAULT** The system forces third party BIOS to display during system boot.
- ➔ **Keep Current** The system displays normal information during system boot.

- **Bootup Num-Lock [On]**

Use the **Bootup Num-Lock** BIOS option to specify if the number lock setting must be modified during boot up.

- ➔ **Off** Does not enable the keyboard Number Lock automatically. To use the 10-keys on the keyboard, press the Number Lock key located on the upper left-hand corner of the 10-key pad. The Number Lock LED on the keyboard lights up when the Number Lock is engaged.
- ➔ **On** **DEFAULT** Allows the Number Lock on the keyboard to be enabled automatically when the computer system boots up. This allows the immediate use of the 10-key numeric keypad located on the right side of the keyboard. To confirm this, the Number Lock LED light on the keyboard is lit.

- **Boot From LAN Support [Disabled]**

Use the **Boot From LAN Support** option to enable the Ethernet controller to boot the system.

- Enabled
- Disabled **DEFAULT**

IQ7 Design Guide

6.5.2 Boot Device Priority

Use the **Boot Device Priority** menu (BIOS Menu 18) to specify the boot sequence from the available devices. The drive sequence also depends on the boot sequence in the individual device section.

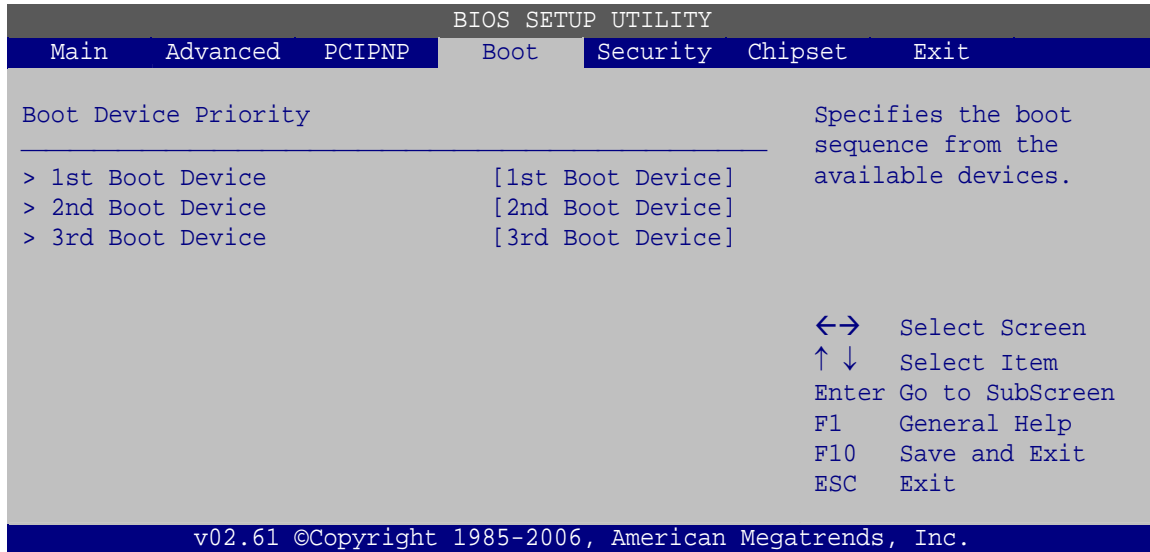

BIOS Menu 18: Boot Device Priority Settings

6.5.3 Hard Disk Drives

Use the **Hard Disk Drives** menu to specify the boot sequence of the available HDDs. Only installed hard drives are shown.

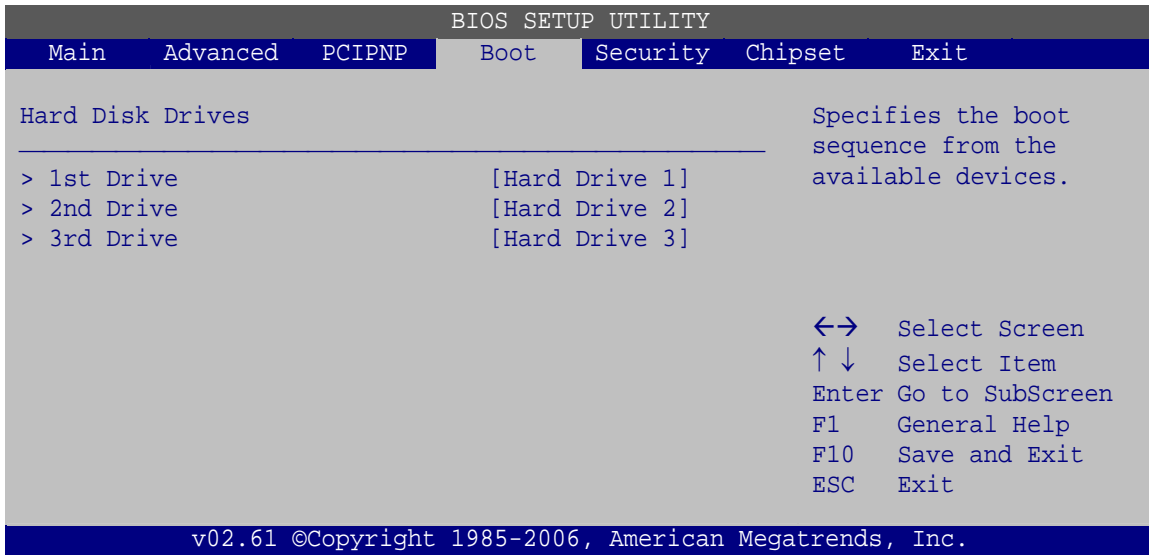

BIOS Menu 19: Hard Disk Drives

6.5.4 Removable Drives

Use the **Removable Drives** menu (BIOS Menu 20) to specify the boot sequence of the removable drives. Only connected drives are shown.

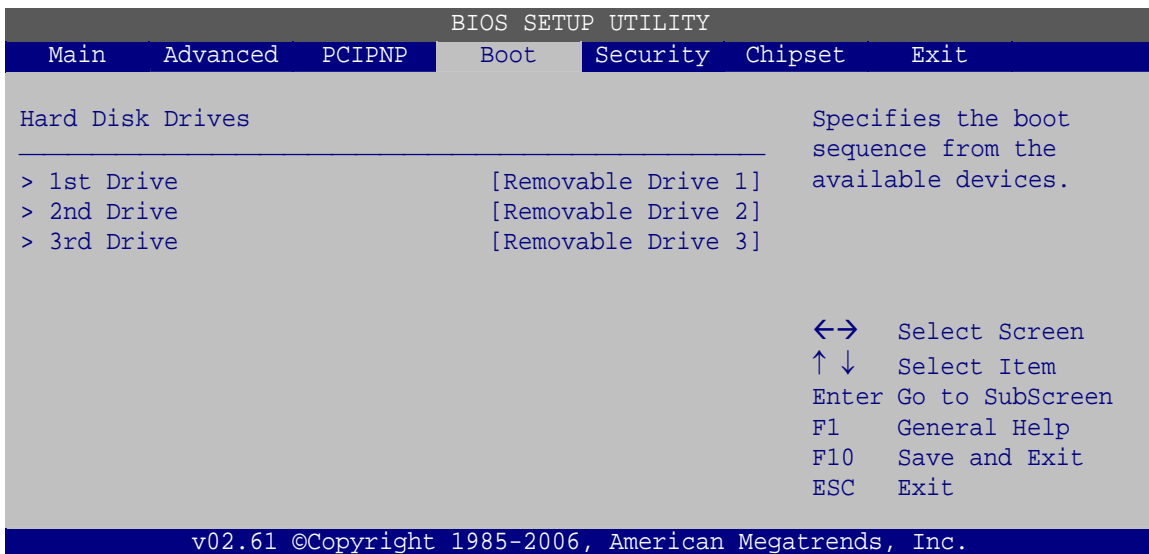

BIOS Menu 20: Removable Drives

IQ7 Design Guide

6.5.5 CD/DVD Drives

Use the **CD/DVD Drives** menu to specify the boot sequence of the available CD/DVD drives. Only connected drives are shown.

```

BIOS SETUP UTILITY
Main  Advanced  PCIPNP  Boot  Security  Chipset  Exit
-----
Hard Disk Drives
-----
> 1st Drive      [CD/DVD 1]
> 2nd Drive      [CD/DVD 2]
> 3rd Drive      [CD/DVD 3]

Specifies the boot
sequence from the
available devices.

<=>  Select Screen
↑↓   Select Item
Enter Go to SubScreen
F1   General Help
F10  Save and Exit
ESC  Exit

v02.61 ©Copyright 1985-2006, American Megatrends, Inc.

```

BIOS Menu 21: CD/DVD Drives

6.6 Security

Use the **Security** menu (BIOS Menu 22) to set system and user passwords.

```

BIOS SETUP UTILITY
Main  Advanced  PCIPNP  Boot  Security  Chipset  Exit
-----
Security Settings
-----
Supervisor Password :Not Installed
User Password       :Not Installed

Change Supervisor Password
Change User Password

<=>  Select Screen
↑↓   Select Item
Enter Go to SubScreen
F1   General Help
F10  Save and Exit
ESC  Exit

v02.61 ©Copyright 1985-2006, American Megatrends, Inc.

```

BIOS Menu 22: Security

- **Change Supervisor Password**

Use the **Change Supervisor Password** to set or change a supervisor password. The default for this option is **Not Installed**. If a supervisor password must be installed, select this field and enter the password. After the password has been added, **Install** appears next to **Change Supervisor Password**.

- **Change User Password**

Use the **Change User Password** to set or change a user password. The default for this option is **Not Installed**. If a user password must be installed, select this field and enter the password. After the password has been added, **Install** appears next to **Change User Password**.

- **Clear User Password**

Use the **Clear User Password** to clear a user's password. The default for this option is **Not Installed**. If a user password must be cleared, use this option.

- **Boot Sector Virus Protection [Disabled]**

Use the **Boot Sector Virus Protection** to enable or disable boot sector protection.

- ➔ **Disabled** **DEFAULT** Disables the boot sector virus protection
- ➔ **Enabled** Enables the boot sector virus protection

6.7 Chipset

Use the **Chipset** menu (BIOS Menu 23) to access the Northbridge and Southbridge configuration menus

```

BIOS SETUP UTILITY
Main  Advanced  PCIPNP  Boot  Security  Chipset  Exit
-----
Advanced Chipset Settings
-----
WARNING: Setting wrong values in below section
         may cause system to malfunction.

> Northbridge Configuration
> Southbridge Configuration

                                  ←→  Select Screen
                                  ↑↓  Select Item
                                  Enter Go to SubScreen
                                  F1   General Help
                                  F10  Save and Exit
                                  ESC  Exit

v02.61 ©Copyright 1985-2006, American Megatrends, Inc.

```

BIOS Menu 23: Chipset

6.7.1 Northbridge Configuration

Use the **Northbridge Chipset Configuration** menu (BIOS Menu 24) to configure the Northbridge chipset.

```

BIOS SETUP UTILITY
Main  Advanced  PCIPNP  Boot  Security  Chipset  Exit
-----
Northbridge Configuration
-----
Integrated Graphics Mode Selec [Enabled, 4MB]
                                Select the amount of
                                system memory used by
                                the Integrated Graphic
                                Device

Boot Display Configuration
-----
Boot Display Device             [Auto]
Flat Panel Type                 [1024x768 18b]

                                  ←→  Select Screen
                                  ↑↓  Select Item
                                  Enter Go to SubScreen
                                  F1   General Help
                                  F10  Save and Exit
                                  ESC  Exit

v02.61 ©Copyright 1985-2006, American Megatrends, Inc.

```

BIOS Menu 24: Northbridge Chipset Configuration

- **Integrated Graphics Mode Select [Enable, 4 MB]**

This setting determines whether the internal graphics device is used, and how much memory it will use.

- Disable
- Enable, 1 MB
- Enable, 4 MB **DEFAULT**
- Enable, 8 MB

- **Boot Display Device**

This option specifies which video device will be used first when booting up. When set to auto, the system will use whichever device is attached.

- Auto **DEFAULT**
- LFP
- CRT

- **Flat Panel Type**

This option specifies the resolution of the flat panel display.

- 640x480, 18-bit
- 800x480, 18-bit
- 800x600, 18-bit
- 1024x768, 18-bit **DEFAULT**
- 1280x1024, 36-bit
- 1400x1050, 36-bit
- 1440x900, 36-bit
- 1600x1200, 36-bit

6.7.2 Southbridge Configuration

The **Southbridge Configuration** menu (BIOS Menu 25) the Southbridge chipset to be configured.

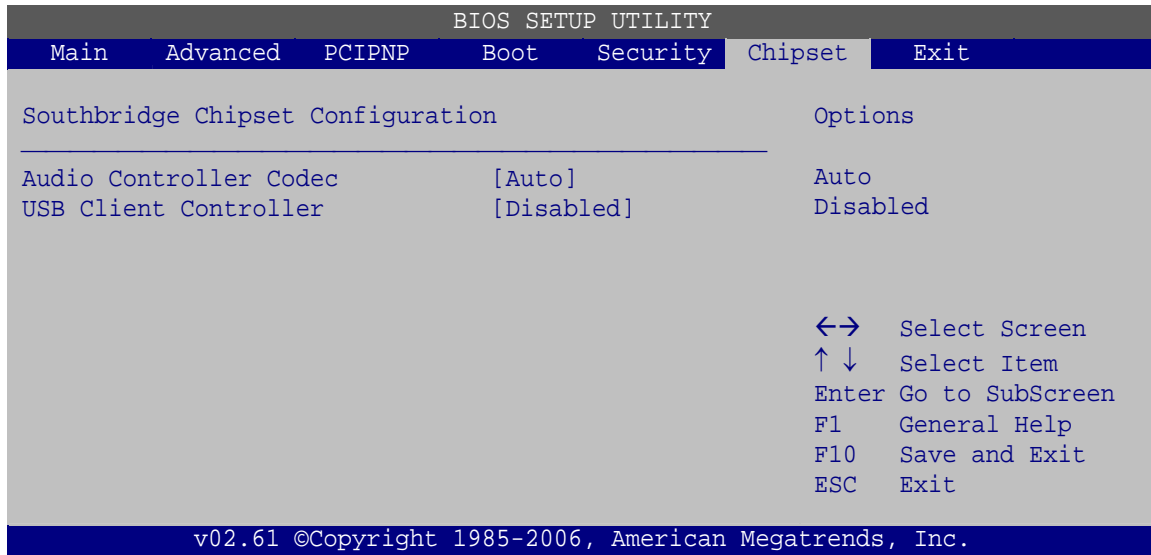

BIOS Menu 25: Southbridge Chipset Configuration

- **Audio Controller Codec [Auto]**

This option enables and disables the High Definition Audio controller.

- ➔ **Auto** **DEFAULT** Enabled when there is a connected audio controller
- ➔ **Disabled** Always disabled

- **USB Client Controller [Disabled]**

This option enables the ability to have an additional USB controller on the baseboard.

6.8 Exit

Use the **Exit** menu (BIOS Menu 26) to load default BIOS values, optimal failsafe values and to save configuration changes.

```

BIOS SETUP UTILITY
Main  Advanced  PCIPNP  Boot  Security  Chipset  Exit
-----
Exit Options
-----
Save Changes and Exit
Discard Changes and Exit
Discard Changes

Load Optimal Defaults
Load Failsafe Defaults

Exit system setup after
saving the changes.

F10 key can be used for
this operation

<->  Select Screen
↑↓   Select Item
Enter Go to SubScreen
F1   General Help
F10  Save and Exit
ESC  Exit

v02.61 ©Copyright 1985-2006, American Megatrends, Inc.

```

BIOS Menu 26: Exit

- **Save Changes and Exit**

Use the **Save Changes and Exit** option to save the changes made to the BIOS options and to exit the BIOS configuration setup program.

- **Discard Changes and Exit**

Use the **Discard Changes and Exit** option to exit the BIOS configuration setup program without saving the changes made to the system.

- **Discard Changes**

Use the **Discard Changes** option to discard the changes and remain in the BIOS configuration setup program.

- **Load Optimal Defaults**

Use the **Load Optimal Defaults** option to load the optimal default values for each of the parameters on the Setup menus. **F9 key can be used for this operation.**

IQ7 Design Guide

- **Load Failsafe Defaults**

Use the **Load Failsafe Defaults** option to load failsafe default values for each of the parameters on the Setup menus. **F8 key can be used for this operation.**



Appendix

A

BIOS Options

IQ7 Design Guide

Below is a list of BIOS configuration options in the BIOS chapter.

▪ System Overview	76
▪ System Time [xx:xx:xx]	77
▪ System Date [xx/xx/xx]	77
▪ Onboard PCI IDE Controller [Primary]	79
▪ IDE Master and IDE Slave	79
▪ Auto-Detected Drive Parameters	80
▪ Type [Auto]	81
▪ LBA/Large Mode [Auto]	81
▪ Block (Multi Sector Transfer) [Auto]	82
▪ PIO Mode [Auto]	82
▪ DMA Mode [Auto]	83
▪ S.M.A.R.T [Auto]	83
▪ 32Bit Data Transfer [Enabled]	84
▪ Serial Port1 Address [3F8]	84
▪ RS-485 Control for SP1 [Disabled]	85
▪ Serial Port2 Address [2F8]	85
▪ RS-485 Control for SP2 [Disabled]	85
▪ Serial Port3 Address [3E8]	85
▪ Serial Port4 Address [2E8]	86
▪ Parallel Port Address [378]	86
▪ Parallel Port Mode [Normal]	86
▪ Parallel Port IRQ [IRQ7]	87
▪ Mode Setting [Full On Mode]	88
▪ TargetTemp [030]	89
▪ Tolerance Value [05]	89
▪ StartUp Value [050]	90
▪ Stop Value [50]	90
▪ StopTime Value [001]	90
▪ AHCI Port n [Not Detected]	91
▪ SATA Port n [Auto]	92
▪ S.M.A.R.T [Enabled]	92
▪ Intel AMT Support	93
▪ BootBlock HECI Message	94

▪ HECI Message [Enabled].....	94
▪ End of Post S5 HECI Message [Enabled]	95
▪ ME-HECI [Enabled]	95
▪ ME-IDER [Enabled]	95
▪ ME-KT [Enabled]	95
▪ Remote Access [Disabled].....	96
▪ Serial Port Number [COM1].....	97
▪ Base Address, IRQ [3F8h,4].....	97
▪ Serial Port Mode [115200 8,n,1].....	97
▪ Redirection After BIOS POST [Always]	97
▪ Terminal Type [ANSI].....	98
▪ Onboard SiS USB1.1 DEVICE [Enabled].....	99
▪ Onboard SiS USB2.0 DEVICE [Enabled].....	99
▪ USB Configuration.....	99
▪ USB Devices Enabled	99
▪ USB Functions [Enabled].....	99
▪ USB 2.0 Controller [Enabled].....	99
▪ Legacy USB Support [Enabled].....	100
▪ USB2.0 Controller Mode [HiSpeed].....	100
▪ USB Mass Storage Reset Delay [20 Sec]	101
▪ Device ##.....	101
▪ Emulation Type [Auto].....	102
▪ IRQ# [Available]	103
▪ Reserved Memory Size [Disabled]	103
▪ Quick Boot [Enabled]	105
▪ Quiet Boot [Disabled]	105
▪ AddOn ROM Display Mode [Force BIOS]	106
▪ Bootup Num-Lock [On]	106
▪ Boot From LAN Support [Disabled]	106
▪ Change Supervisor Password	110
▪ Change User Password.....	110
▪ Clear User Password	110
▪ Boot Sector Virus Protection [Disabled]	110
▪ Integrated Graphics Mode Select [Enable, 4 MB].....	112
▪ Boot Display Device	112

IQ7 Design Guide

▪ Flat Panel Type.....	112
▪ Audio Controller Codec [Auto].....	113
▪ USB Client Controller [Disabled].....	113
▪ Save Changes and Exit	114
▪ Discard Changes and Exit.....	114
▪ Discard Changes.....	114
▪ Load Optimal Defaults.....	114
▪ Load Failsafe Defaults.....	115



Appendix

B

Terminology

IQ7 Design Guide

AC '97	Audio Codec 97 (AC'97) refers to a codec standard developed by Intel® in 1997.
ACPI	Advanced Configuration and Power Interface (ACPI) is an OS-directed configuration, power management, and thermal management interface.
AHCI	Advanced Host Controller Interface (AHCI) is a SATA Host controller register-level interface.
ATA	The Advanced Technology Attachment (ATA) interface connects storage devices including hard disks and CD-ROM drives to a computer.
ARMD	An ATAPI Removable Media Device (ARMD) is any ATAPI device that supports removable media, besides CD and DVD drives.
ASKIR	Amplitude Shift Keyed Infrared (ASKIR) is a form of modulation that represents a digital signal by varying the amplitude (“volume”) of the signal. A low amplitude signal represents a binary 0, while a high amplitude signal represents a binary 1.
BIOS	The Basic Input/Output System (BIOS) is firmware that is first run when the computer is turned on and can be configured by the end user
CODEC	The Compressor-Decompressor (CODEC) encodes and decodes digital audio data on the system.
CompactFlash®	CompactFlash® is a solid-state storage device. CompactFlash® devices use flash memory in a standard size enclosure. Type II is thicker than Type I, but a Type II slot can support both types.
CMOS	Complimentary metal-oxide-conductor is an integrated circuit used in chips like static RAM and microprocessors.
COM	COM refers to serial ports. Serial ports offer serial communication to expansion devices. The serial port on a personal computer is usually a male DB-9 connector.
DAC	The Digital-to-Analog Converter (DAC) converts digital signals to analog signals.
DDR	Double Data Rate refers to a data bus transferring data on both the rising and falling edges of the clock signal.

DMA	Direct Memory Access (DMA) enables some peripheral devices to bypass the system processor and communicate directly with the system memory.
DIMM	Dual Inline Memory Modules are a type of RAM that offer a 64-bit data bus and have separate electrical contacts on each side of the module.
DIO	The digital inputs and digital outputs are general control signals that control the on/off circuit of external devices or TTL devices. Data can be read or written to the selected address to enable the DIO functions.
EHCI	The Enhanced Host Controller Interface (EHCI) specification is a register-level interface description for USB 2.0 Host Controllers.
EIDE	Enhanced IDE (EIDE) is a newer IDE interface standard that has data transfer rates between 4.0 MBps and 16.6 MBps.
EIST	Enhanced Intel® SpeedStep Technology (EIST) allows users to modify the power consumption levels and processor performance through application software. The application software changes the bus-to-core frequency ratio and the processor core voltage.
FSB	The Front Side Bus (FSB) is the bi-directional communication channel between the processor and the Northbridge chipset.
GbE	Gigabit Ethernet (GbE) is an Ethernet version that transfers data at 1.0 Gbps and complies with the IEEE 802.3-2005 standard.
GPIO	General purpose input
HDD	Hard disk drive (HDD) is a type of magnetic, non-volatile computer storage device that stores digitally encoded data.
ICH	The Input/Output Control Hub (ICH) is an Intel® Southbridge chipset.
IrDA	Infrared Data Association (IrDA) specify infrared data transmission protocols used to enable electronic devices to wirelessly communicate with each other.
L1 Cache	The Level 1 Cache (L1 Cache) is a small memory cache built into the system processor.
L2 Cache	The Level 2 Cache (L2 Cache) is an external processor memory cache.

IQ7 Design Guide

LCD	Liquid crystal display (LCD) is a flat, low-power display device that consists of two polarizing plates with a liquid crystal panel in between.
LVDS	Low-voltage differential signaling (LVDS) is a dual-wire, high-speed differential electrical signaling system commonly used to connect LCD displays to a computer.
POST	The Power-on Self Test (POST) is the pre-boot actions the system performs when the system is turned-on.
RAM	Random Access Memory (RAM) is volatile memory that loses data when power is lost. RAM has very fast data transfer rates compared to other storage like hard drives.
SATA	Serial ATA (SATA) is a serial communications bus designed for data transfers between storage devices and the computer chipsets. The SATA bus has transfer speeds up to 1.5 Gbps and the SATA II bus has data transfer speeds of up to 3.0 Gbps.
S.M.A.R.T	Self Monitoring Analysis and Reporting Technology (S.M.A.R.T) refers to automatic status checking technology implemented on hard disk drives.
UART	Universal Asynchronous Receiver-transmitter (UART) is responsible for asynchronous communications on the system and manages the system's serial communication (COM) ports.
UHCI	The Universal Host Controller Interface (UHCI) specification is a register-level interface description for USB 1.1 Host Controllers.
USB	The Universal Serial Bus (USB) is an external bus standard for interfacing devices. USB 1.1 supports 12Mbps data transfer rates and USB 2.0 supports 480Mbps data transfer rates.
VGA	The Video Graphics Array (VGA) is a graphics display system developed by IBM.

Appendix

C

Hazardous Materials Disclosure

C.1 Hazardous Materials Disclosure Table for IPB Products Certified as RoHS Compliant Under 2002/95/EC Without Mercury

The details provided in this appendix are to ensure that the product is compliant with the Peoples Republic of China (China) RoHS standards. The table below acknowledges the presences of small quantities of certain materials in the product, and is applicable to China RoHS only.

A label will be placed on each product to indicate the estimated “Environmentally Friendly Use Period” (EFUP). This is an estimate of the number of years that these substances would “not leak out or undergo abrupt change.” This product may contain replaceable sub-assemblies/components which have a shorter EFUP such as batteries and lamps. These components will be separately marked.

Please refer to the table on the next page.

Part Name	Toxic or Hazardous Substances and Elements					
	Lead (Pb)	Mercury (Hg)	Cadmium (Cd)	Hexavalent Chromium (CR(VI))	Polybrominated Biphenyls (PBB)	Polybrominated Diphenyl Ethers (PBDE)
Housing	X	O	O	O	O	X
Display	X	O	O	O	O	X
Printed Circuit Board	X	O	O	O	O	X
Metal Fasteners	X	O	O	O	O	O
Cable Assembly	X	O	O	O	O	X
Fan Assembly	X	O	O	O	O	X
Power Supply Assemblies	X	O	O	O	O	X
Battery	O	O	O	O	O	O

O: This toxic or hazardous substance is contained in all of the homogeneous materials for the part is below the limit requirement in SJ/T11363-2006

X: This toxic or hazardous substance is contained in at least one of the homogeneous materials for this part is above the limit requirement in SJ/T11363-2006

IQ7 Design Guide

此附件旨在确保本产品符合中国 RoHS 标准。以下表格标示此产品中某有毒物质的含量符合中国 RoHS 标准规定的限量要求。

本产品上会附有“环境友好使用期限”的标签，此期限是估算这些物质“不会有泄漏或突变”的年限。本产品可能包含有较短的环境友好使用期限的可替换元件，像是电池或灯管，这些元件将会单独标示出来。

部件名称	有毒有害物质或元素					
	铅 (Pb)	汞 (Hg)	镉 (Cd)	六价铬 (CR(VI))	多溴联苯 (PBB)	多溴二苯 醚 (PBDE)
壳体	X	O	O	O	O	X
显示	X	O	O	O	O	X
印刷电路板	X	O	O	O	O	X
金属螺帽	X	O	O	O	O	O
电缆组装	X	O	O	O	O	X
风扇组装	X	O	O	O	O	X
电力供应组装	X	O	O	O	O	X
电池	O	O	O	O	O	O

O: 表示该有毒有害物质在该部件所有物质材料中的含量均在 SJ/T11363-2006 标准规定的限量要求以下。
X: 表示该有毒有害物质至少在该部件的某一均质材料中的含量超出 SJ/T11363-2006 标准规定的限量要求。