

## LVDS-DVI

18-bit LVDS to DVI converter board, resolution support up to 1366x768

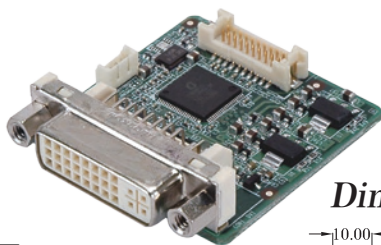

Dimensions (Unit: mm)

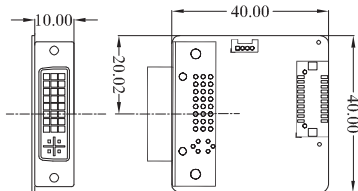

### Features

- ◆ Provide DVI option for dual display output
- ◆ Resolution supported: 1366x768, 1024x768, 800x600, 640x480
- ◆ 18 or 24-bit LVDS to DVI converter board

### Supported Models

WSB-PV-D5251	PICOe-PV-D5251	PCISA-PV-D5251
KINO-PV-D5252	NOVA-PV-D5251	NANO-PV-D5251
NANO-PV-D5252	WAFER-PV-D5252	

### Packing List

1 x LVDS to DVI converter board	
1 x SMBus cable	1 x QIG

### Ordering Information

LVDS-DVI-R10	18/24-bit LVDS to DVI converter board
32602-012200-100-RS	20-pin to 30-pin LVDS connecting cable for WAFER-PV-D5252 only
32602-012300-100-RS	20-pin to 30-pin LVDS connecting cable

## LVDS-VGA-R10

Single-channel LVDS to VGA converter board

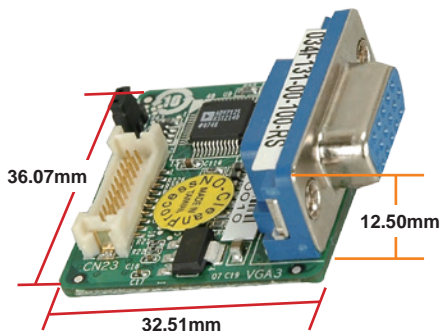

Dimensions (Unit: mm)

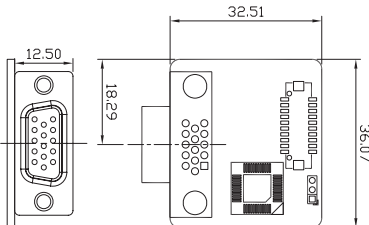

### Features

- ◆ Provide 2nd VGA option for dual VGA display
- ◆ Resolution adjust by BIOS: Support 1024x768, 800x600, 640x480
- ◆ 18-bit LVDS to VGA converter board

### Packing List

1 x LVDS to VGA converter board	
1 x QIG	

### Ordering Information

Part No.	Description
LVDS-VGA-R10	18-bit LVDS to VGA converter board
32600-112300-RS	30-pin LVDS connecting cable
32600-114400-RS	20-pin LVDS connecting cable

## LVDS-VGA02

18-bit LVDS to VGA converter board, resolution support up to 1366x768

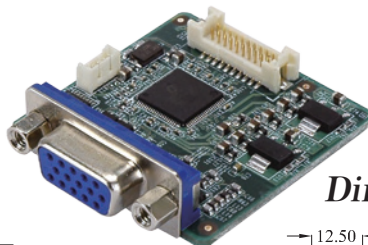

Dimensions (Unit: mm)

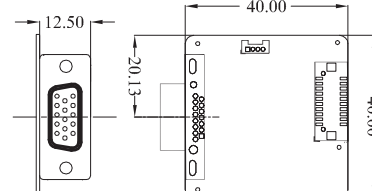

### Features

- ◆ Provide VGA option for dual VGA display output
- ◆ Resolution supported: 1366x768, 1024x768, 800x600, 640x480
- ◆ 18 or 24-bit LVDS to VGA converter board

### Supported Models

WSB-PV-D5251	PICOe-PV-D5251	PCISA-PV-D5251
KINO-PV-D5252	NOVA-PV-D5251	NANO-PV-D5251
NANO-PV-D5252	WAFER-PV-D5252	

### Packing List

1 x LVDS to VGA converter board	
1 x SMBus cable	1 x QIG

### Ordering Information

LVDS-VGA02-R10	18/24-bit LVDS to VGA converter board
32602-012200-100-RS	20-pin to 30-pin LVDS connecting cable for WAFER-PV-D5252 only
32602-012300-100-RS	20-pin to 30-pin LVDS connecting cable

## LVDS24-01

18-bit to 24-bit LVDS converter board

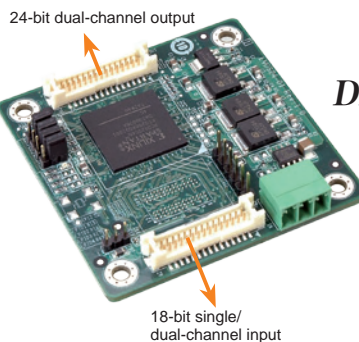

Dimensions (Unit: mm)

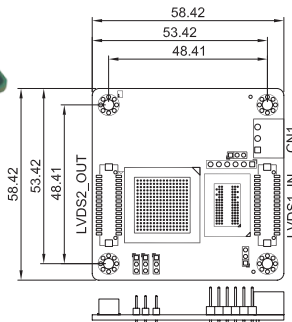

### Features

- ◆ Resolution supports up to 1280x1024
- ◆ Support below configuration:
  - › Single-channel 18-bit to single-channel 24-bit
  - › Single-channel 18-bit to dual-channel 24-bit
  - › Dual-channel 18-bit to dual-channel 24-bit

\* Note: The module does not support dual-channel 18-bit to single-channel 24-bit conversion.

### Packing List

1 x 18-bit to 24-bit LVDS converter board	
1 x Power cable (P/N: 32100-130300-RS)	
1 x QIG	

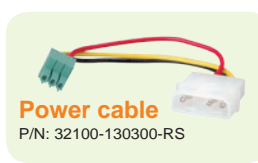

Power cable  
P/N: 32100-130300-RS

### Ordering Information

Part No.	Description
LVDS24-01-R10	18-bit to 24-bit LVDS converter board
32600-004900-RS	30-pin LVDS connection cable for evaluation
32602-007900-100-RS	Single-channel 18-bit 20-pin to 24-bit LVDS 30-pin connection cable
32602-008000-100-RS	Dual-channel 18-bit 30-pin to 24-bit 30-pin LVDS connection cable

1

Industrial  
Computing  
Solutions

2

Video  
Capture  
Solutions

3

Embedded  
Computing  
Solutions

4

ORing  
Network  
Communication

5

Power Supply/  
Peripherals

6

Panel  
Solutions  
Introduction