

# Industrial Device Server User's Manual

---

## IDS-5042 Series



Version 1.00

Aug 2010.



Oring Industrial Networking Corp.

4F., NO.3, Lane235, Baociao Rd.Sindian City,

Taipei County 23145 Taiwan, R.O.C.

Tel: + 886 2 2918 3036

Fax: + 886 2 2918 3084

Website : [www.oring-networking.com](http://www.oring-networking.com)

E-mail : [support@oring-networking.com](mailto:support@oring-networking.com)

# Table of Content

<b>GETTING TO KNOW YOUR DEVICE SERVER .....</b>	<b>1</b>
1.1 <i>About the IDS-5042 Serial Device Server .....</i>	1
1.2 <i>Software Features .....</i>	1
1.3 <i>Hardware Features .....</i>	2
<b>HARDWARE INSTALLATION .....</b>	<b>3</b>
2.1 <i>Install IDS-5042 on DIN-Rail .....</i>	3
2.1.1    Mount IDS-5042 on DIN-Rail.....	3
2.2 <i>Wall Mounting Installation .....</i>	4
2.2.1    Mount IDS-5042 on wall .....	5
<b>HARDWARE OVERVIEW.....</b>	<b>8</b>
3.1 <i>Front Panel .....</i>	8
3.2 <i>Front Panel LEDES.....</i>	9
3.3 <i>Serial Ports .....</i>	10
3.4 <i>Bottom Panel.....</i>	11
3.5 <i>Rear Panel.....</i>	12
<b>CABLES .....</b>	<b>13</b>
4.1 <i>Ethernet Cables.....</i>	13
<b>MANAGEMENT INTERFACE .....</b>	<b>15</b>
5.1 <i>DS-Tool.....</i>	15
5.1.1    Install IDS-Tool.....	15
5.1.2    Using DS-Tool .....	17
5.1.2.1    Explore device servers .....	17
5.1.2.2    Configure device servers.....	18
5.1.2.3    Configure serial port.....	28
5.2 <i>Configuration by Web Browser.....</i>	37
5.2.1    Connect to the Web page.....	37
5.2.1.1    System.....	39
5.2.1.2    Port serial setting.....	45
5.2.1.3    Management .....	53



5.2.1.4	Save/Reboot.....	58
5.3	<i>Configuration by SSH Console</i> .....	59
5.3.1	Connect to DS.....	59
<b>TECHNICAL SPECIFICATIONS .....</b>		<b>61</b>



# Getting to Know Your Device Server

## 1.1 About the IDS-5042 Serial Device Server



IDS-5042 / 5042+ / 5042-I+ is an innovative 4 ports RS232/422 /485 to 2 ports LAN device server with optional isolation RS-422 / 485 serial ports and one P.O.E PD Ethernet port.. Users are able to configure IDS-5042 by DS-Tool via LAN port. IDS-5042 offers many powerful features for HW & SW redundant functions. When the connection between master-link and LAN fails, the IDS-5042 can automatically switch to another LAN port within 10mS, and still guarantee a non-stop connection.

IDS-5042 also supports switch mode, users can use Daisy Chain to reduce the usage of Ethernet switch ports. Secondly, the IDS-5042 can simultaneously transfer data into 5 host PCs. This feature can assure all critical data that saved in different host PCs to avoid Ethernet break or host PCs failure. Device also supports the data encryption with SSL, so it can assure the data transfer safely.

Thirdly, the IDS-5042 provides dual redundant power inputs on terminal block. IDS-5042 also provides NAT pass through function so that users are able to manage IDS-5042 inside or outside the NAT router. It is easy for different IP domain users to use IDS-5042. Therefore, IDS-5042 is the best communication redundant solution for current application of serial devices.

## 1.2 Software Features

- High Speed Air Connectivity: WLAN interface support up to 54Mbps link speed



- Highly Security Capability: WEP/WPA/WPA2/802.1X/Radius/TKIP supported
- NAT-pass through: User can manage IDS-5042 through NAT router
- PPPoE for internet connection.
- Data Encryption with SSL for Security data transfer.
- DDNS for domain name service.
- Redundant Power Inputs: 12~48VDC on power jack and terminal block
- Redundant multiple host devices: 5 simultaneous in Virtual COM, TCP Server, TCP Client mode, UDP
- Secured Management by HTTPS and SSH,
- Versatile Modes: Virtual Com, Serial Tunnel, TCP Server, TCP Client, UDP
- Event Warning by Syslog, Email, SNMP trap, and Beeper
- Various Windows O.S. supported: Windows NT/2000/ XP/ 2003/VISTA

### 1.3 Hardware Features

- Redundant Power Inputs: 12~48 VDC on terminal block and power jack
- Operating Temperature: -10 to 60°C
- Storage Temperature: -40 to 85°C
- Operating Humidity: 5% to 95%, non-condensing
- Casing: IP-30
- 2 10/100Base-T(X) Ethernet port
- 1 optional P.O.E PD port (IDS-5042+ and IDS-5042-I+)
- 4 isolated serial port (IDS-5042I+)
- Dimensions(W x D x H) : 52 mm(W)x 106 mm( D )x 144 mm(H)

# Hardware Installation

## 2.1 Install IDS-5042 on DIN-Rail

Each IDS-5042 has a Din-Rail kit on rear panel. The Din-Rail kit helps IDS-5042 to fix on the Din-Rail. It is easy to install the IDS-5042 on the Din-Rail:

### 2.1.1 Mount IDS-5042 on DIN-Rail

Step 1: Slant the IDS-5042 and mount the metal spring to Din-Rail.



Figure 2-1

Step 2: Push the IDS-5042 toward the Din-Rail until you heard a “click” sound.

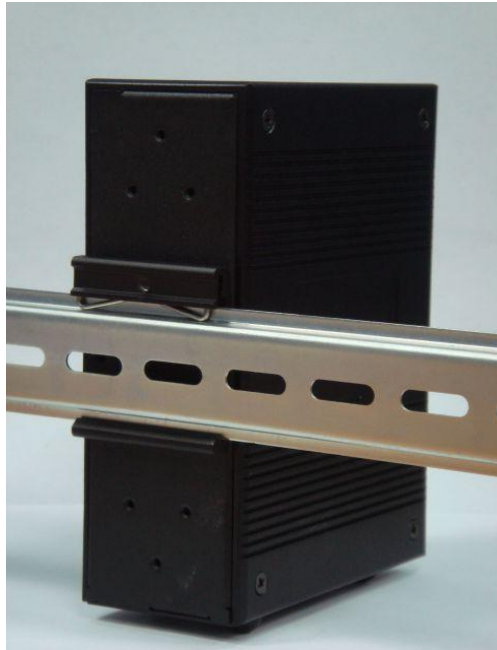

*Figure 2-2*

## 2.2 Wall Mounting Installation

Each IDS-5042 has another installation method for you. A wall mount panel can be found in the package. The following steps show how to mount the IDS-5042 on the wall:



## 2.2.1 Mount IDS-5042 on wall

Step 1: Remove Din-Rail kit.

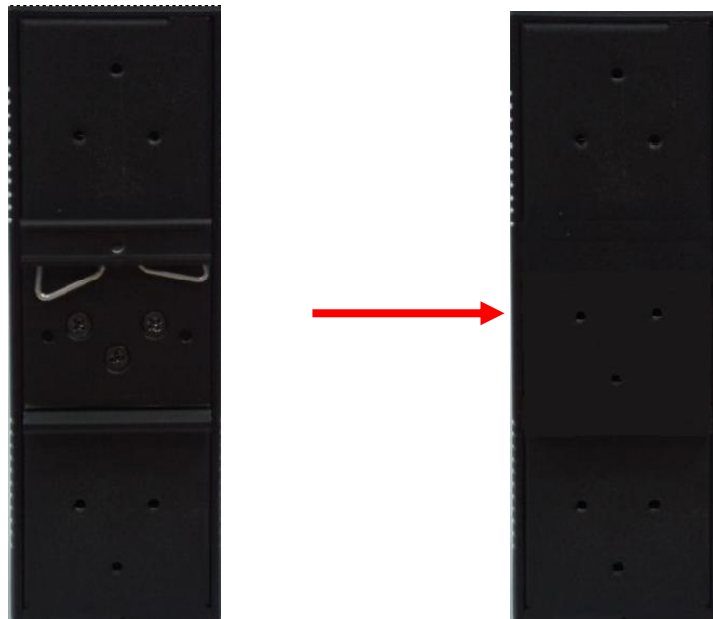

Figure 2-3

Step 2: Use 6 screws that can be found in the package to combine the wall mount panel.  
Just like the picture shows below:



Figure 2-4

The screws specification shows in the following two pictures. In order to prevent IDS-5042 from any damage, the size of screws should not be larger than the size that used in IDS-5042.

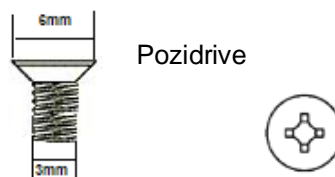

Figure 2-5

Step 3: Mount the combined IDS-5042 on the wall. .



Figure 2-6

# Hardware Overview

## 3.1 Front Panel

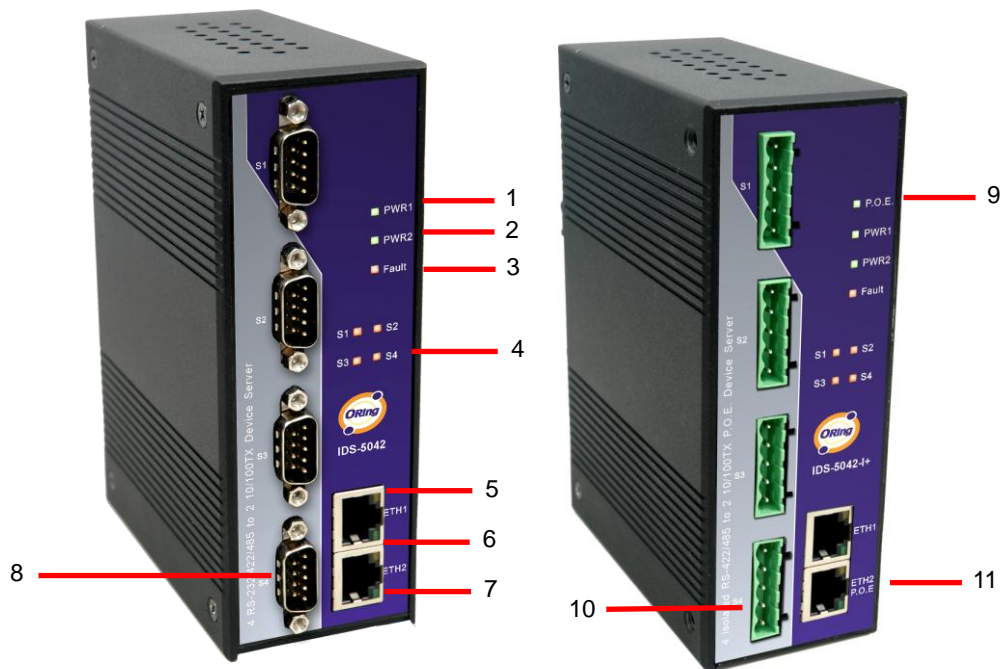

Figure 3-1

1. LED for PWR1 and system status. When the PWR1 links, the green LED will be light on.
2. LED for PWR2 and system status. When the PWR2 links, the green LED will be light on.
3. LED for fault indicator. When fault occurred, this red LED will be light on.
4. LED for Serial ports status. When data transmitted, the green LED will be light on. When data received, the red LED will be light on.
5. LED of 10Base-T connection on Ethernet port.



6. 10/100Base-T(X) Ethernet port
7. LED of 100Base-TX connection on Ethernet port.
8. RS-232/422/485 serial port. Mode configured by DS-Tool.
9. LED for P.O.E. and system status. When the P.O.E. power connected, the green LED will be light on.. (IDS-5042+ and IDS-5042-I+)
10. RS-422/485 serial port with 2KV isolation. Mode configured by DS-Tool.
11. 10/100Base-T(X) Ethernet port. (P.O.E. PD port, IDS-5042+ and IDS-5042-I+)

### 3.2 Front Panel LEDS

The following table describes the labels that stick on the IDS-5042.

LED	Color	Status	Description
P.O.E	Green / Red	On	Power supplied over Ethernet Cable
		Red Blinking	Indicates and IP conflict, or DHCP or BOOTP server did not respond properly
PWR1	Green/Red	On	DC power 1 activated.
		Red blinking	Indicates an IP conflict, or DHCP or BOOTP server did not respond properly
PWR2	Green/Red	On	DC power 2 activated.
		Red blinking	Indicates an IP conflict, or DHCP or BOOTP server did not respond properly
Fault	Red	On	Fault event occurred.
S1 ~ S4	Green	Blinking	Serial port is transmitting data
	Red	Blinking	Serial port is receiving data

ETH1	Green/Amber	Green On/Blinking	100Mbps LNK/ACT
		Amber On/Blinking	10Mbps LNK/ACT
ETH2	Green/Amber	Green On/Blinking	100Mbps LNK/ACT
		Amber On/Blinking	10Mbps LNK/ACT

Table 3-1 Front panel LEDs

### 3.3 Serial Ports

There 4 serial ports on the front panel of IDS-5042 shown as below:

DB9 connector

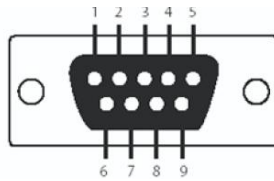

Pin #	RS 232	RS 422	RS 485 ( 4 wire )	RS 485 ( 2 wire )
1	DCD	RXD -	RXD -	
2	RXD	RXD +	RXD +	
3	TXD	TXD +	TXD +	DATA +
4	DTR	TXD -	TXD -	DATA -
5	GND	GND	GND	GND
6	DSR			
7	RTS			
8	CTS			
9	RI			
RS 232 mod act as DTE				

Table 3-2 Pin assignment

**5 Pin Terminal block connector**

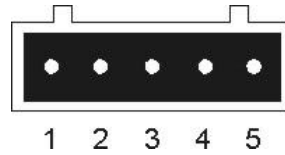

Pin #	RS 422	RS 485 ( 4 wire )	RS 485 ( 2 wire )
1	GND	GND	GND
2	RXD -	RXD -	
3	RXD +	RXD +	
4	TXD -	TXD -	DATA -
5	TXD +	TXD +	DATA +

### 3.4 Bottom Panel

The bottom panel components of IDS-5042/42+/42-I+ are shown as below:

1. Terminal block includes: PWR1, PWR2 (12 ~ 48V DC) and Relay output (1A@24VDC).
2. Reset button. 5 seconds for factory default.

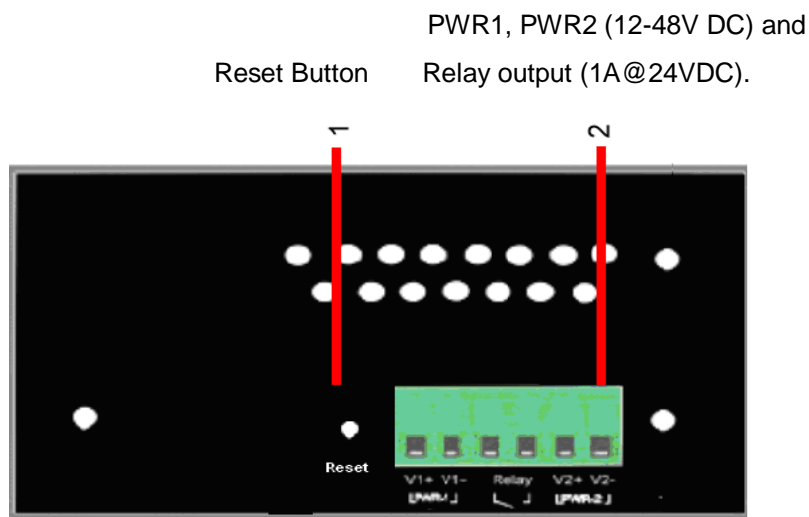
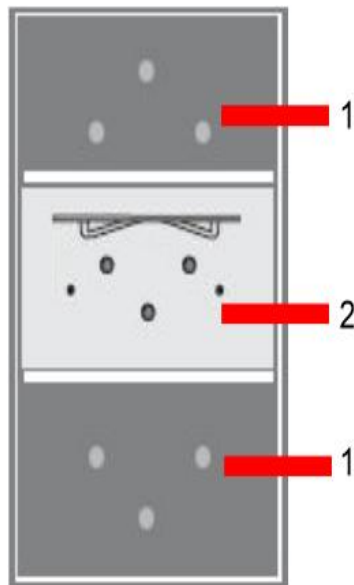

Figure 3-2 Bottom Panel

### 3.5 Rear Panel

The rear panel components of IDS-5042 are shown as below:

1. Screw holes for wall mount kit.
2. Din-Rail kit



*Figure 3-3 Rear Panel*





# Cables

## 4.1 Ethernet Cables

The IDS-5042 has standard Ethernet ports. According to the link type, the IDS-5042 use CAT 3, 4, 5, 5e UTP cables to connect to any other network device (PCs, servers, switches, routers, or hubs). Please refer to the following table for cable specifications.

Cable	Type	Max. Length	Connector
10BASE-T	Cat. 3, 4, 5 100-ohm	UTP 100 m (328 ft)	RJ-45
100BASE-TX	Cat. 5 100-ohm UTP	UTP 100 m (328 ft)	RJ-45

*Table 4-1 Cable Types and Specifications*

### 100BASE-TX/10BASE-T Pin Assignments

With 100BASE-TX/10BASE-T cable, pins 1 and 2 are used for transmitting data, and pins 3 and 6 are used for receiving data.



Pin Number	Assignment
1	TD+
2	TD-
3	RD+
4	P.O.E. power input +
5	P.O.E. power input +
6	RD-
7	P.O.E. power input -
8	P.O.E. power input -

*Table 4-2 RJ-45 Pin Assignments*

The IDS-5042 supports auto MDI/MDI-X operation. You can use a straight-through cable to connect PC to IDS-5042. The following table below shows the 10BASE-T/ 100BASE-TX MDI and MDI-X port pin outs.

Pin Number	MDI port	MDI-X port
1	TD+(transmit)	RD+(receive)
2	TD-(transmit)	RD-(receive)
3	RD+(receive)	TD+(transmit)
4	P.O.E. power input +	P.O.E. power input +
5	P.O.E. power input +	P.O.E. power input +
6	RD-(receive)	TD-(transmit)
7	P.O.E. power input -	P.O.E. power input -
8	P.O.E. power input -	P.O.E. power input -

*Table 4-2 MDI / MDI-X pins assignment*

**Note:** "+" and "-" signs represent the polarity of the wires that make up each wire pair.

# Management Interface

## 5.1 DS-Tool

DS-Tool is a powerful Windows utility for DS series. It supports device discovery, device configuration, group setup, group firmware update, monitoring functions...etc. It is easy for you to install and configure devices over the network.

### 5.1.1 Install IDS-Tool

Step 1: Execute the Setup program, click “**start**” after selecting the folder for DS-Tool.

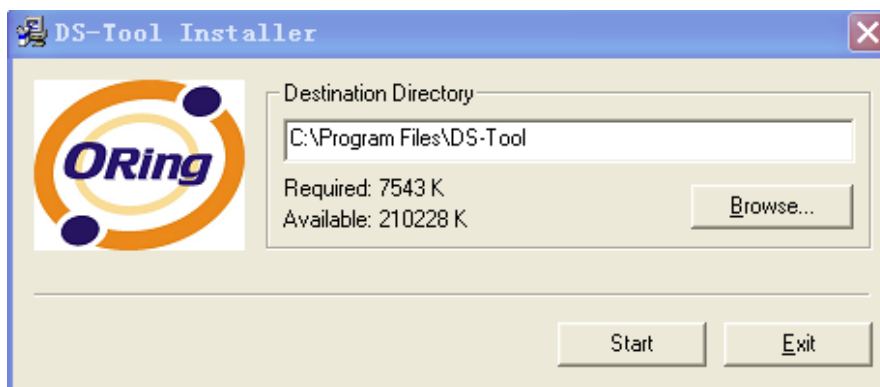

Figure 5-1

Step 2: When installation complete successfully, then click "OK".

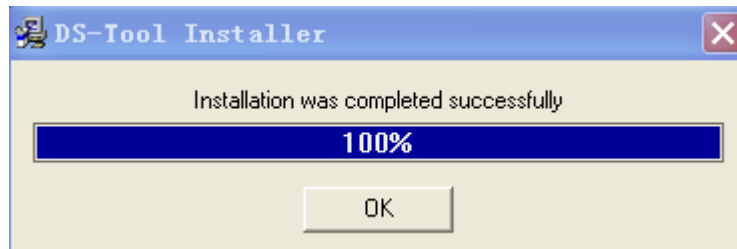

Figure 5-2

Step 3: Check for your selection.



Figure 5-3

## 5.1.2 Using DS-Tool

### 5.1.2.1 Explore device servers

DS-Tool will broadcast to the network and search all available DS devices in the network. The default IP address of device is “**192.168.10.2**”, and selects the searching device you wish to use and press “**Add**” button.

You can set static IP address or in DHCP client mode to get IP address automatically. Finally, click “**OK**” button to add the device.

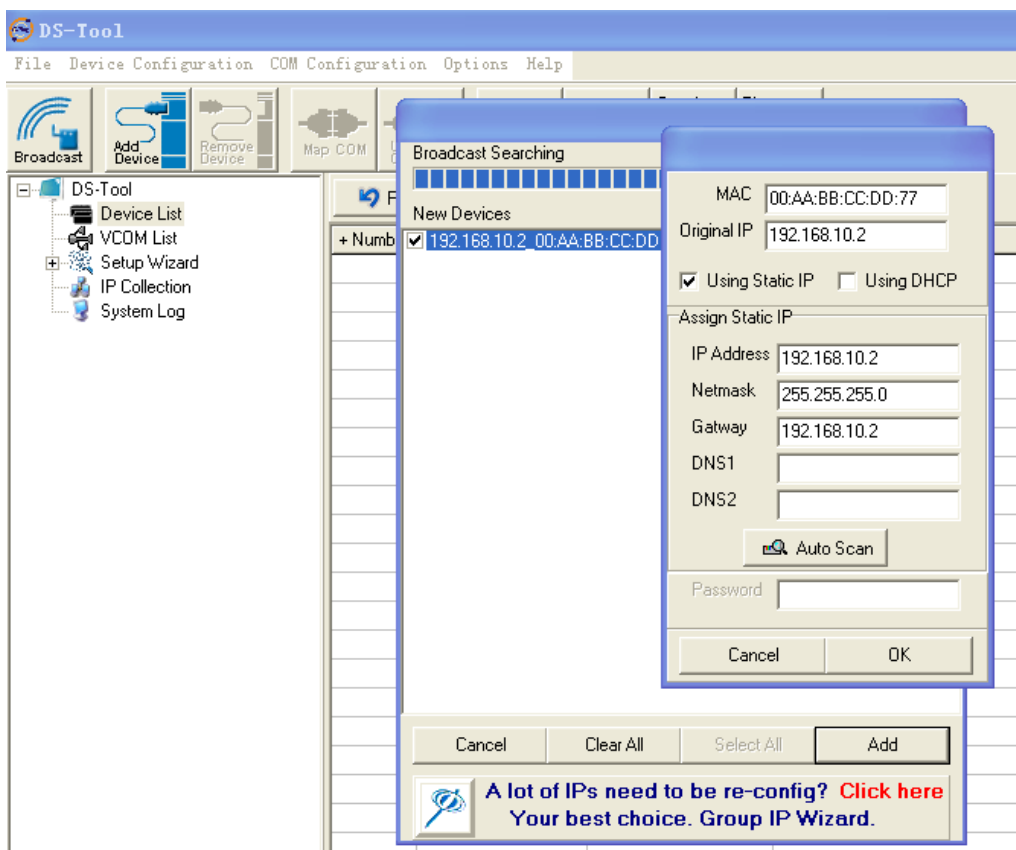

Figure 5-4



## 5.1.2.2 Configure device servers

### General settings

This page includes the setting of device name, SNTP server and Auto IP Report.

Figure 5-5 General settings

The following table describes the labels in this screen.

Label	Description
Device Name/location	You can set the device name or related information. By clicking “Locate On” button you can locate the serial server’s position.
Set SNTP	Input the SNTP server domain name or IP address, port and select the Time zone.

Set Auto IP Report	By Clicking the “ <b>Get current Host</b> ” button you will get your local IP, and then set the Report interval time. The device server will report its status periodically.
--------------------	--

Table 5-1 General settings

At IP collection option show the device server status. The report interval is 0 indicate disable this setting (default). But you can set the other IP or Port.

### Security

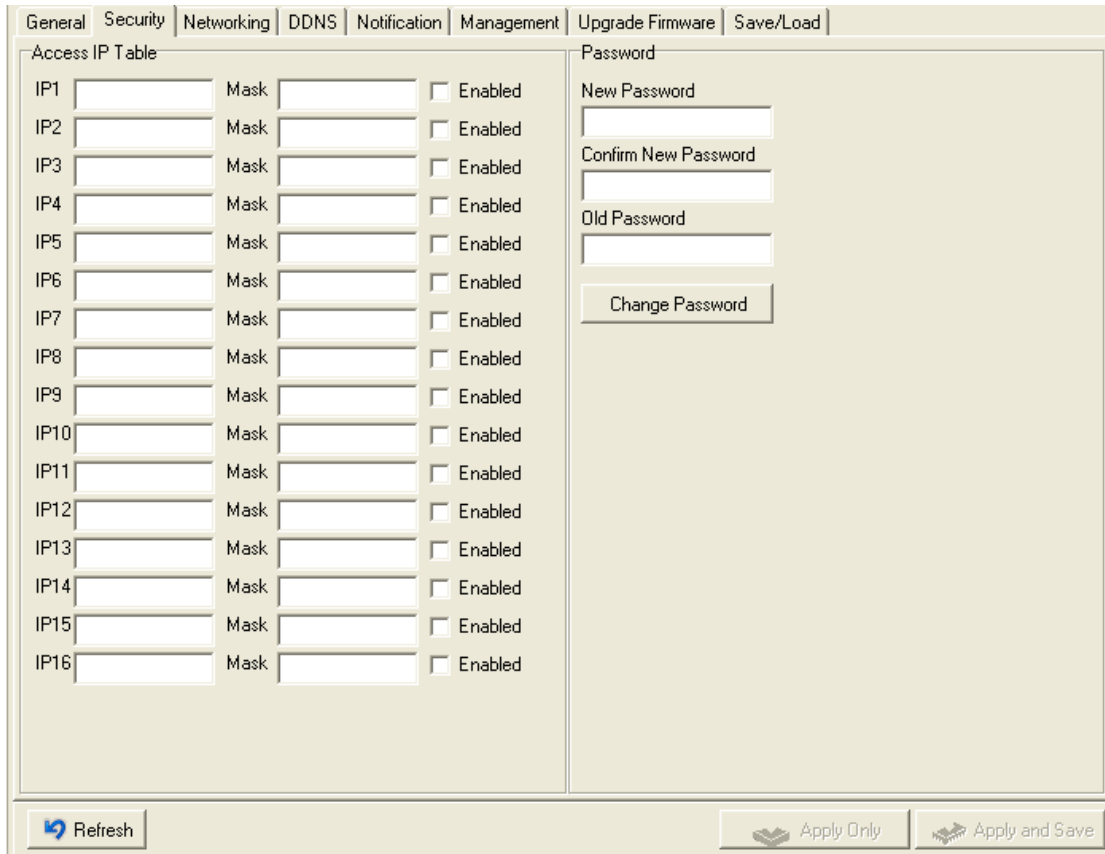

Figure 5-6 Security

The following table describes the labels in this screen.

Label	Description
Accessible IP Setting	To prevent unauthorized access by setting host IP addresses and network masks.



Password setting	You can set the password to prevent unauthorized access from your server. Factory default is no password.
------------------	---

Table 5-2 Security

## Network Setting

Device can connect the Network by wire. You must assign a valid IP address for DS before attached in your network environment. Your network administrator should provide you the IP address and related settings. The IP address must be unique within the network (otherwise, DS will not have a valid connection to the network). You can choose from three possible “**IP configuration**” modes: Static, DHCP/BOOTP. The Factory Default IP address is “**192.168.10.2**”

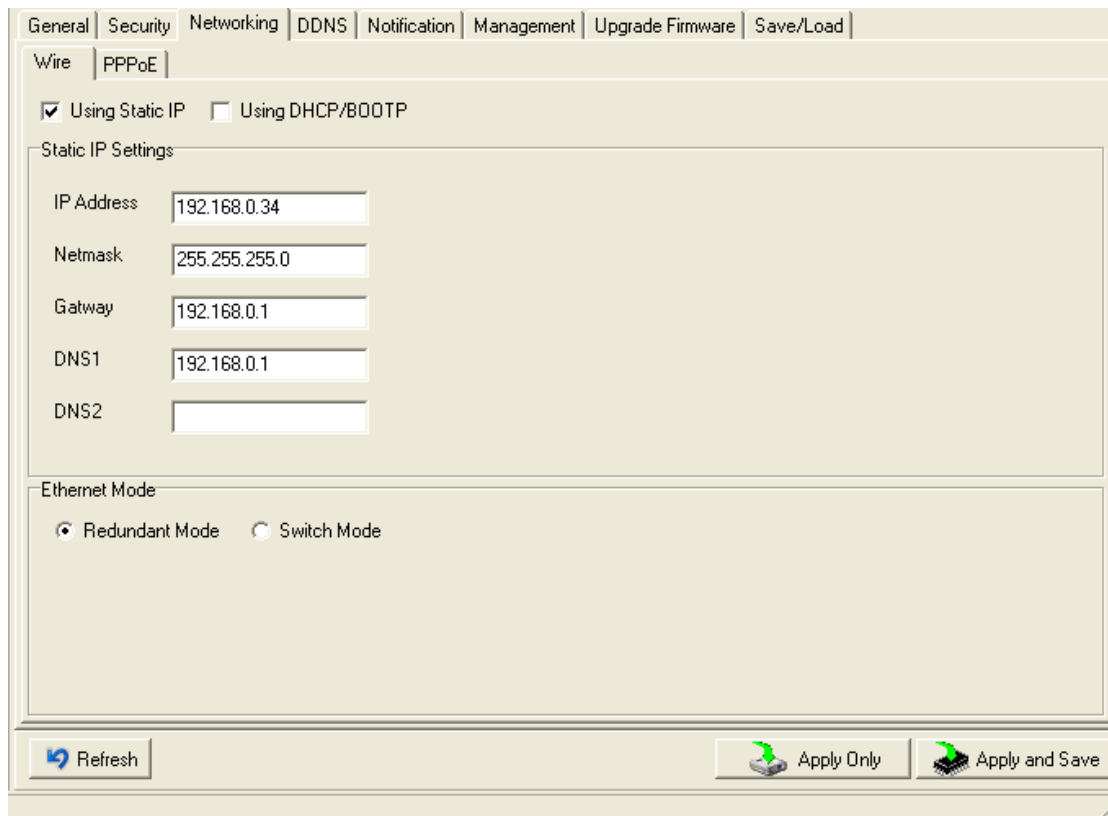

Figure 5-7 Network Setting



The following table describes the labels in this screen.

Label	Description
Using DHCP/BOOTP	IP Address automatically assigned by a DHCP server in your network.
Static IP Address	Manually assigning an IP address.
Subnet Mask	All devices on the network must have the same subnet mask to communicate on the network.
Gateway	Enter the IP address of the router in you network.
DNS Server	Enter the IP address of the DNS server, The DNS server translates domain names into IP address.
Switch Mode	<b>Redundant:</b> When the connection between master-link and LAN fails, the DS can automatically switch to another LAN port within10mS, and still guarantees a non-stop connection <b>Switch:</b> Daisy Chain support to reduce usage of switch ports.

Table 5-3 Network setting

## PPPoE

PPPoE (Point-to-Point Protocol over Ethernet), Device can use PPPoE mode to connect the Network. Input the “**username**” and “**Password**”, then click “**Connect**” button. If the device has been connected, the “**Link Status**” will become the “Link up” and device will get an IP address from PPPoE server。Click “**Disconnect**” button to disconnect the PPPoE connection.

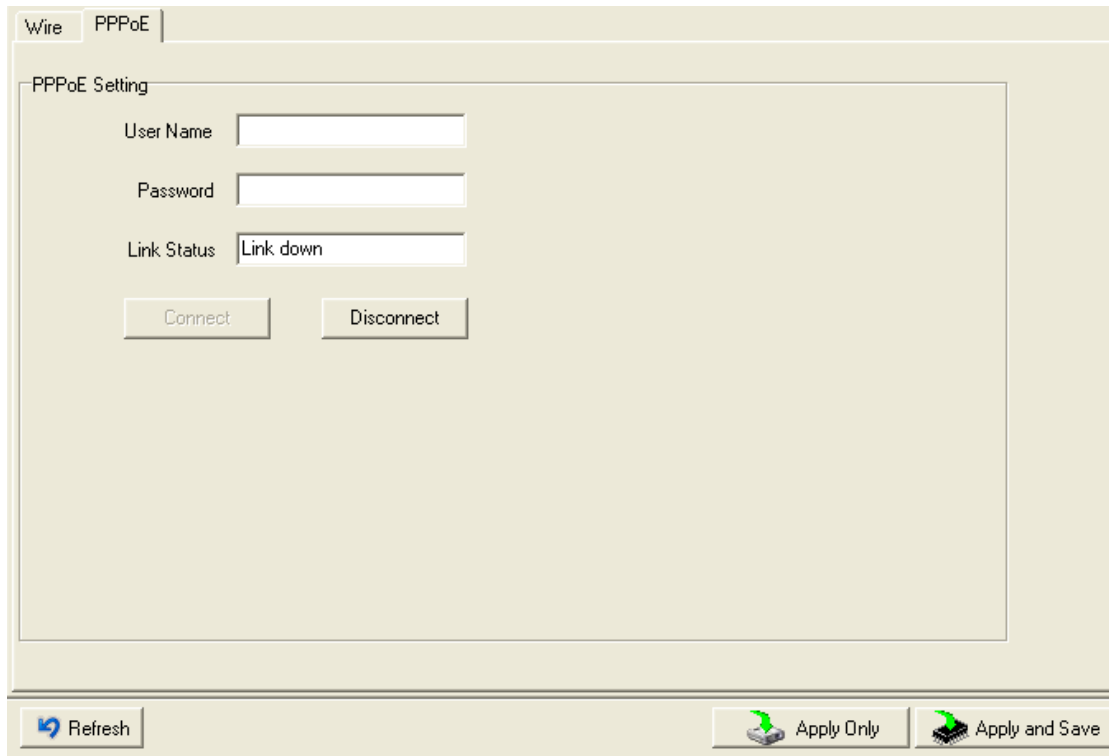

The screenshot shows a web interface for configuring PPPoE settings. At the top, there are two tabs: 'Wire' and 'PPPoE', with 'PPPoE' being the active tab. Below the tabs is a large rectangular area titled 'PPPoE Setting'. Inside this area, there are three input fields: 'User Name', 'Password', and 'Link Status'. The 'Link Status' field is currently set to 'Link down'. Below these fields are two buttons: 'Connect' and 'Disconnect'. At the bottom of the interface, there are three buttons: 'Refresh' (with a circular arrow icon), 'Apply Only' (with a green checkmark icon), and 'Apply and Save' (with a green checkmark and a floppy disk icon).

Figure 5-8 PPPoE Setting

## DDNS

The Dynamic DNS service allows you to alias a dynamic IP address to a static hostname, allowing your computer to be more easily accessed from various locations on the Internet.

General | Security | Networking | **DDNS** | Notification | Management | Upgrade Firmware | Save/Load

DDNS Enable

DDNS Setting

Service Provider:

Hostname:

Account:

Password:

Check WAN IP Schedule:  Start at:  (Hour) :  (Minute)

Figure 5-9 DDNS Setting

The following table describes the labels in this screen.

Label	Description
Service Provider	Choose the DDNS service Provider
Hostname	You must first apply an account from the DDNS service Provider such as www.dyndns.org, then register with the dynamic DNS service. Input the fixed hostname you got from the DDNS service.
Account and Password	Input the Account and Password you have registered from the DDNS service Provider.
Check WAN IP Schedule	Device will check the IP address Status at interval time you set.

Table 5-4 DDNS setting



### Notification

Specify the events that should be notified to the administrator. The events can be alarmed by E-mail, SNMP trap, or system log.

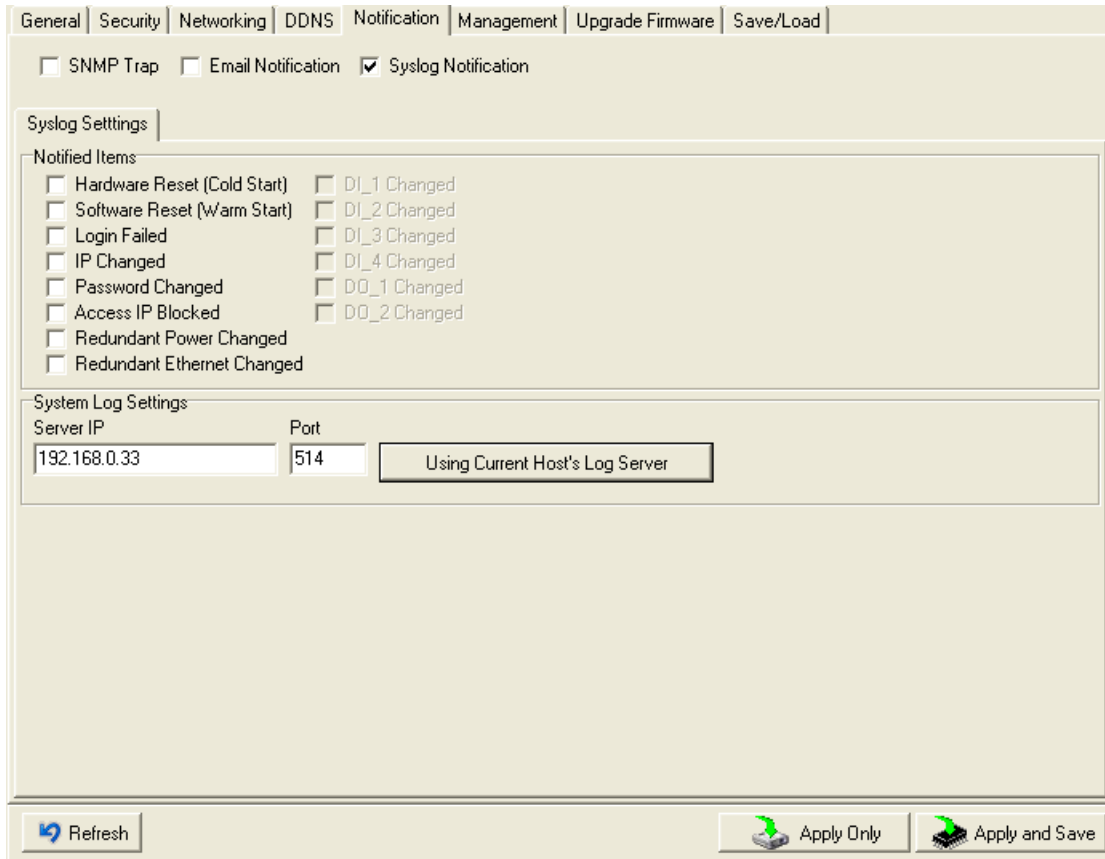

Figure 5-10 Notification

The following table describes the labels in this screen.

Label	Description
SNMP Trap	To notify events by SNMP trap.
Email Notification	To notify events by Email.
Syslog Notification	To notify events by Syslog.
Notify items	Events to be notified.

Apply	Apply current setting.
Apply and Save	Apply and save current setting.

Table 5-5 Notification

## Management

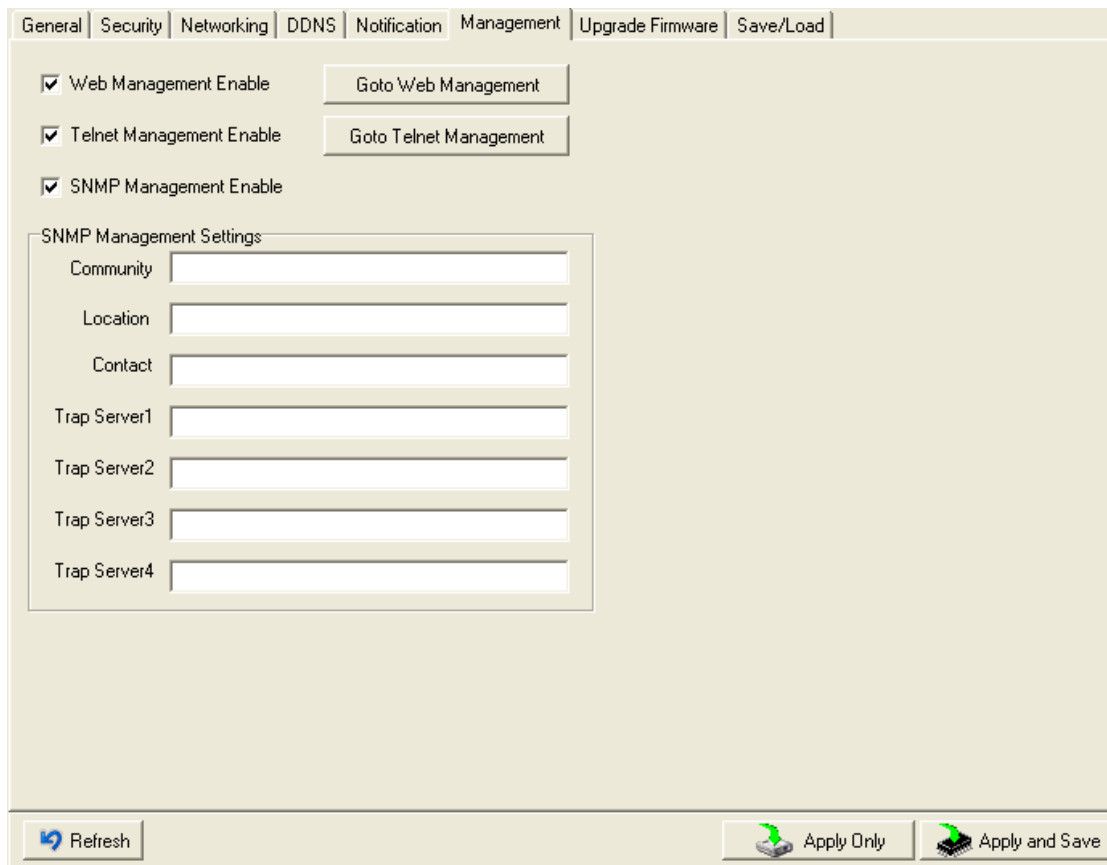

Figure 5-11 Management

The following table describes the labels in this screen.

Label	Description
Web Management Enable	To enable management from Web. Click <b>"Goto Web Management"</b> button to access web.
Telnet Management	To enable management by Telnet. Click <b>"Goto Telnet"</b>

Enable	<b>Management</b> " button to execute Telnet command.
SNMP Management Enable	To enable management by SNMP.
SNMP Management Settings	To configure SNMP related settings.

Table 5-6 Management

### Upgrade Firmware

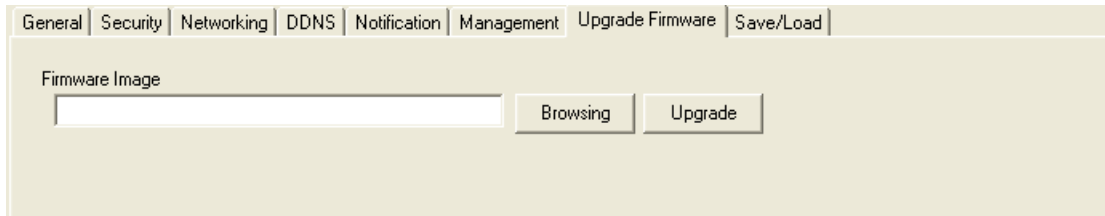

Figure 5-12 Upgrade Firmware

The following table describes the labels in this screen.

Label	Description
Browsing	Browse the file and upgrade
Upgrade	Enable the firmware upgrade.

Table 5-7 Upgrade Firmware

## Save/Load

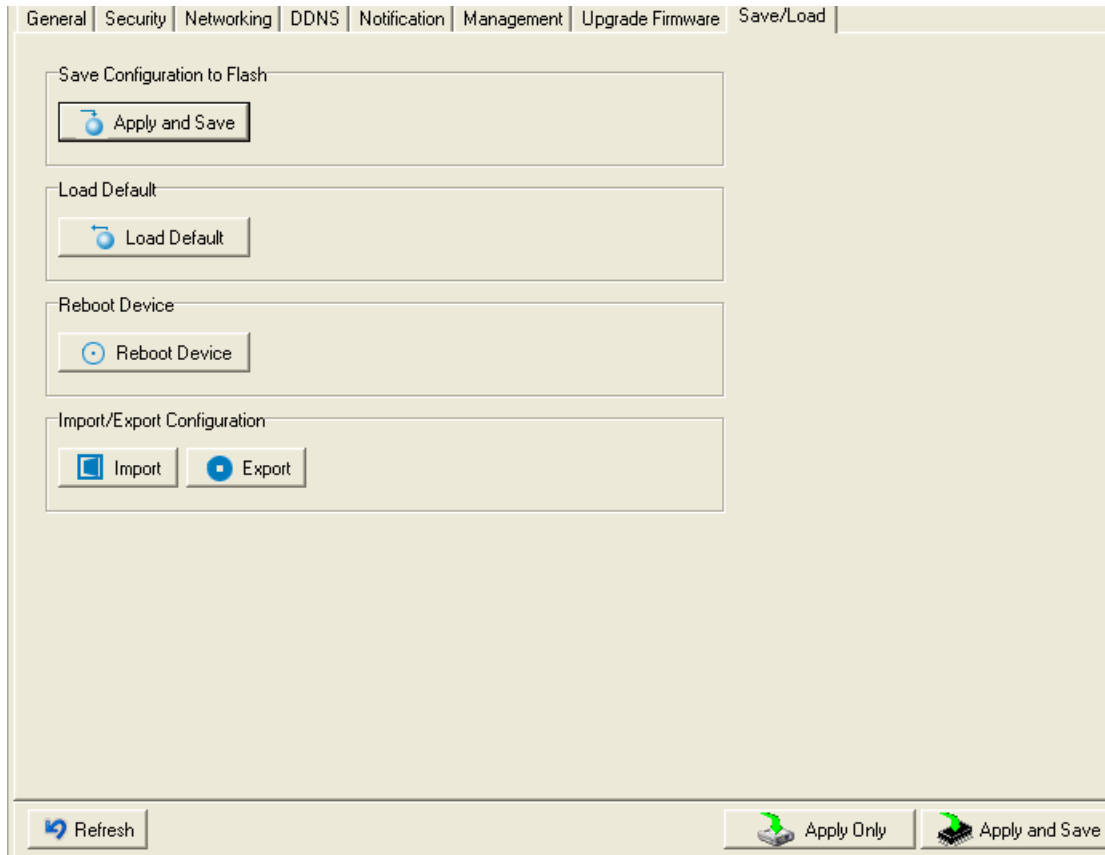

Figure 5-13 Save / Load

The following table describes the labels in this screen.

Label	Description
Save Configuration to Flash	Save current configuration into flash memory.
Load Default	Load default configuration except the network settings. If you want to load all factory default, you need to press " <b>Reset</b> " button on the device (Hardware restore).
Reboot Device	Reboot the device server (warm start).



Import Configuration	Restore the previous exported configuration.
Export Configuration	Exported current configuration to a file to backup the configuration.

Table 5-8 Save / Load

### 5.1.2.3 Configure serial port

#### Serial Settings

Figure 5-14Serial Settings





The following table describes the labels in this screen.

Label	Description
Port Alias	Remark the port to hint the connected device.
Interface	RS232/RS422 / RS485(2-wires) / RS485(4-wires)
Baud rate	110bps/300bps/1200bps/2400bps/4800bps/9600bps/19200bps/ 38400bps/57600bps/115200bps/230400bps/460800bps
Data Bits	5, 6, 7, 8
Stop Bits	1, 2 (1.5)
Parity	No, Even, Odd, Mark, Space
Flow Control	No, XON/XOFF, RTS/CTS, DTR/DSR
Performance	Throughput: This mode optimized for highest transmission speed. Latency: This mode optimized for shortest response time.
Serial to Ethernet	<p><b>Delimiter:</b> You can define max. 4 delimiters (00~FF, Hex) for each way. The data will be hold until the delimiters are received or the option-"<b>Flush Serial to Ethernet data buffer</b>" times out. 0 means disable. Factory default is 0.</p> <p><b>Flush Data Buffer After:</b> The received data will be queuing in the buffer until all the delimiters are matched. When the buffer is full (4K Bytes) or after "<b>flush S2E data buffer</b>" timeout the data will also be sent. You can set the time from 0 to 65535 seconds.</p>
Ethernet to Serial	<p><b>Delimiter:</b> You can define max. 4 delimiters (00~FF, Hex) for each way. The data will be hold until the delimiters are received or the option "<b>Flush Ethernet to Serial data buffer</b>" times out. 0 means disable. Factory default is 0.</p> <p><b>Flush Data Buffer After:</b> The received data will be queuing in the buffer until all the delimiters are matched. When the buffer is full (4K Bytes) or after "<b>flushE2S data buffer</b>" timeout the data will also be sent. You can set the time from 0 to 65535 seconds.</p>



Force TX Interval Time	<p>Force TX interval time is to specify the timeout when no data has been transmitted.</p> <p>When the timeout is reached or TX buffer is full (4K Bytes), the queued data will be sent.</p> <p>0 means disable. Factory default value is 0.</p>
------------------------	--

Table 5-9 Serial settings

### Service Mode – Virtual COM Mode

In Virtual COM Mode, The driver establishes a transparent connection between host and serial device by mapping the Port of the serial server serial port to local COM port on the host computer. Virtual COM Mode also supports up to 5 simultaneous connections, so that multiple hosts can send or receive data by the same serial device at the same time.

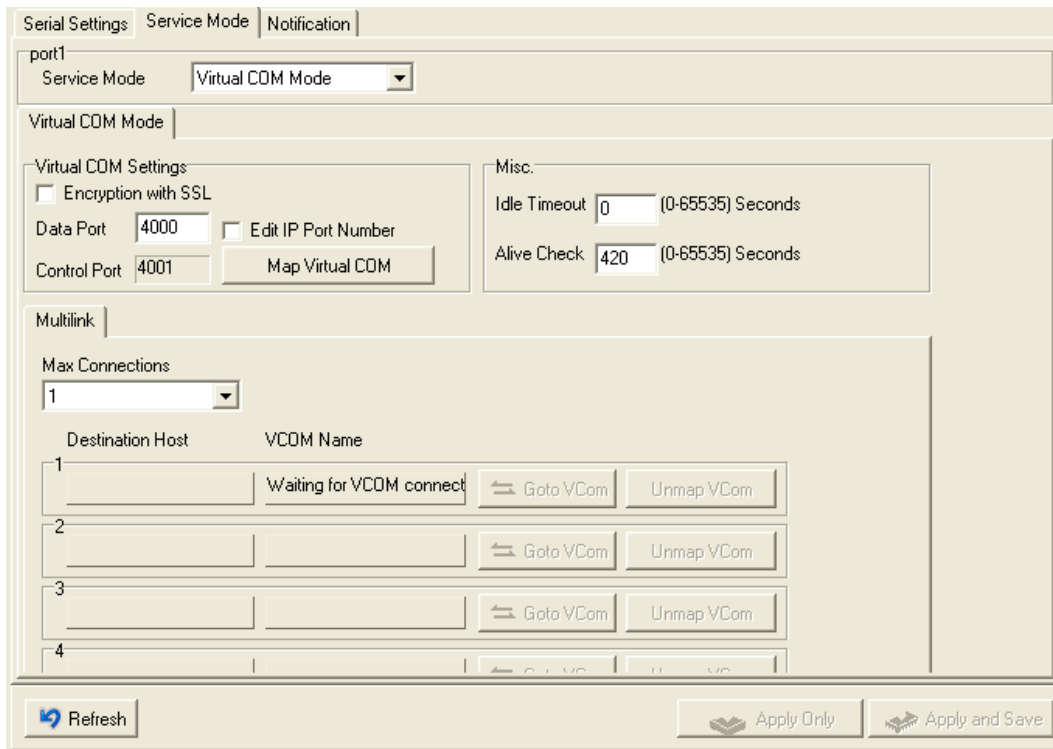

Figure 5-15 Virtual COM



The following table describes the labels in this screen.

Label	Description
Encryption with SSL	Use SSL to encrypt data.
Map Virtual COM	Select a Virtual COM Name to map on.
Max Connection	The number of Max connection can support simultaneous connections are 5, default values is 1.
Idle Timeout	When serial port stops data transmission for a defined period of time (Idle Timeout), the connection will be closed and the port will be freed and try to connect with other hosts. 0 indicate disable this function. Factory default value is 0. If Multilink is configured, only the first host connection is effective for this setting.
Alive Check	The serial device will send TCP alive-check package in each defined time interval (Alive Check) to remote host to check the TCP connection. If the TCP connection is not alive, the connection will be closed and the port will be freed. 0 indicate disable this function. Factory default is 0.

Table 5-10 Virtual COM

*\*Not allowed to mapping Virtual COM from web*

## Service Mode – TCP Server Mode

In TCP Server Mode, DS is configured with a unique Port combination on a TCP/IP network. In this case, DS waits passively to be contacted by the device. After a connection is established, it can then proceed with data transmission. TCP Server mode also supports up to 5 simultaneous connections, so that multiple device can receive data from the same serial device at the same time.

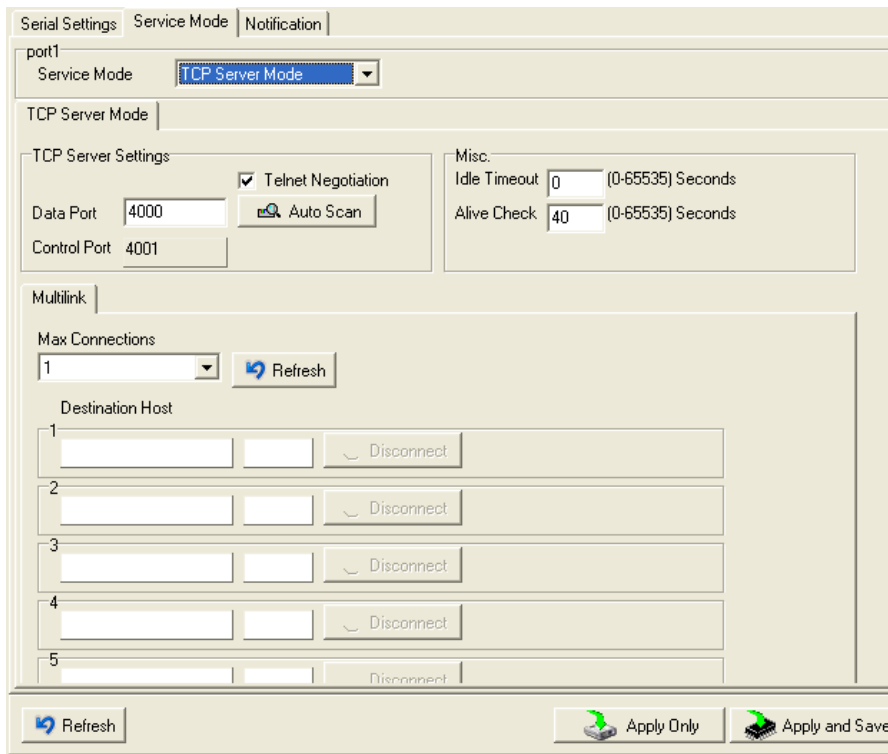

Figure 5-16 TCP Server mode

The following table describes the labels in this screen.

Label	Description
Encryption with SSL	Use SSL to encrypt data.
Data Port	Set the port number for data transmission.
Telnet Negotiation	Full Telnet command / symbol compatible
Auto Scan	Scan the data port automatically.
Idle Timeout	When serial port stops data transmission for a defined period of time (Idle Timeout), the connection will be closed and the port will be freed and try to connect with other hosts. 0 indicate disable this function. Factory default value is 0. If Multilink is configured, only the first host connection is effective for this setting.
Alive Check	The serial device will send TCP alive-check package in each defined time interval (Alive Check) to remote host to check the TCP connection. If the TCP connection is not alive, the connection will be closed and the port will be freed. 0 indicate disable this function. Factory default is 0.

Max Connection	The number of Max connection can support simultaneous connections are 5, default values is 1.
----------------	---

Table 5-11 TCP Server mode

### Service Mode – TCP Client Mode

In TCP Client Mode, device can establish a TCP connection with server by the method you have settled (Startup or any character). After the data has been transferred, device can disconnect automatically from the server by using the TCP alive check time or Idle time settings.

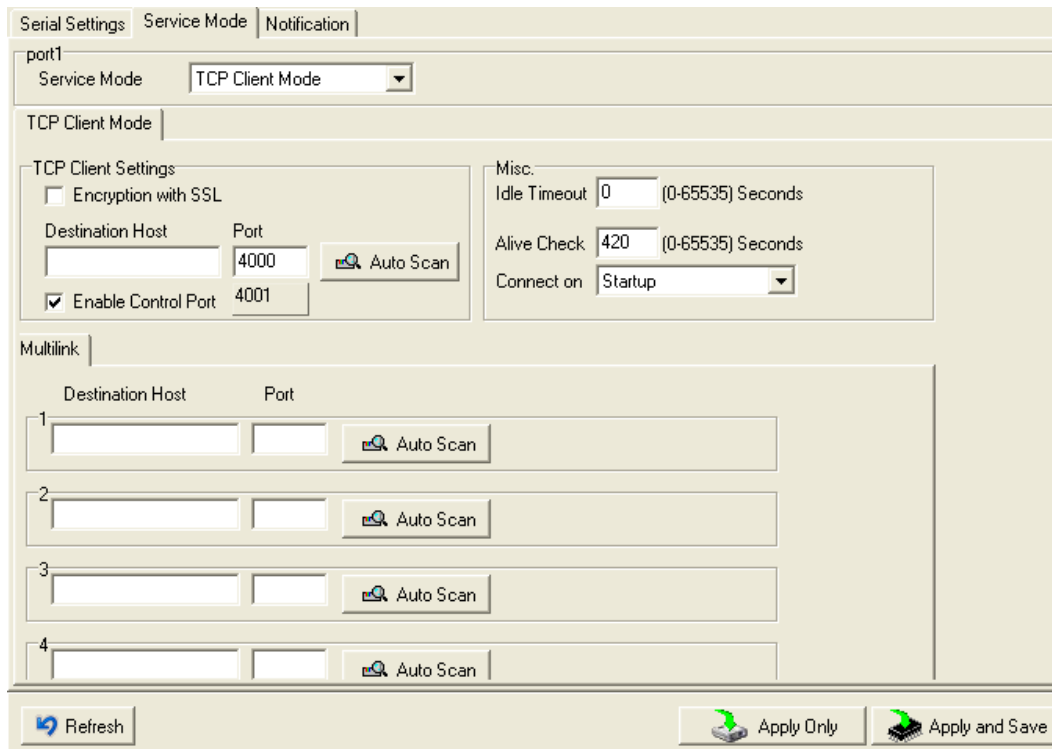

Figure 5-17 TCP Client Mode

The following table describes the labels in this screen.

Label	Description
Encryption with SSL	Use SSL to encrypt data.



Destination Host	Set the IP address of host.
Port	Set the port number of data port.
Idle Timeout	When serial port stops data transmission for a defined period of time (Idle Timeout), the connection will be closed and the port will be freed and try to connect with other hosts. 0 indicate disable this function. Factory default value is 0. If Multilink is configured, only the first host connection is effective for this setting.
Alive Check	The serial device will send TCP alive-check package in each defined time interval (Alive Check) to remote host to check the TCP connection. If the TCP connection is not alive, the connection will be closed and the port will be freed. 0 indicate disable this function. Factory default is 0.
Connect on Startup	The TCP Client will build TCP connection once the connected serial device is started.
Connect on Any Character	The TCP Client will build TCP connection once the connected serial device starts to send data.

*Table 5-12 TCP Client mode*

### **Service Mode – UDP Mode**

Compared to TCP communication, UDP is faster and more efficient. In UDP mode, you can Uni-cast or Multi-cast data from the serial device server to host computers, and the serial device can also receive data from one or multiple host

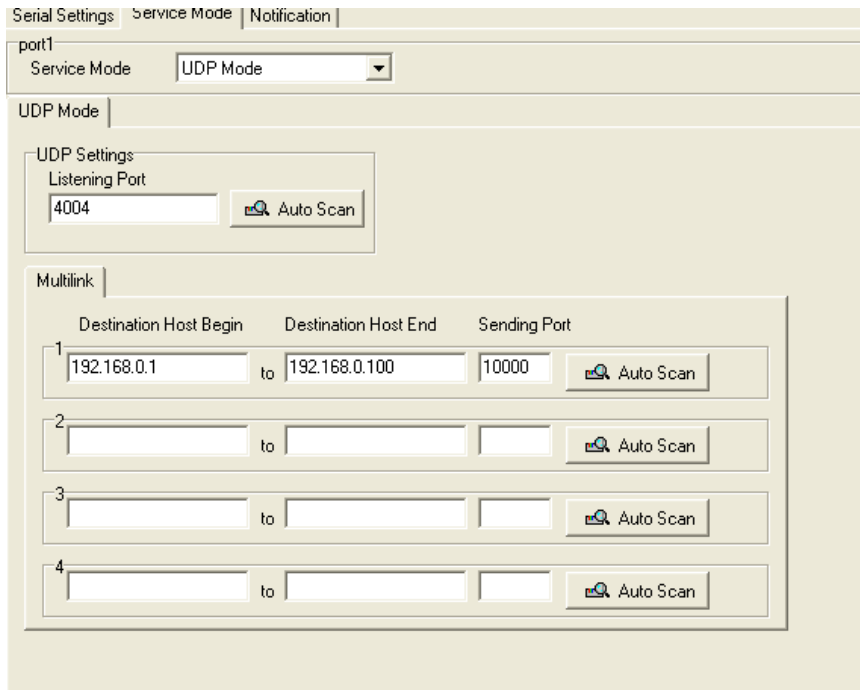

The screenshot displays the configuration interface for the ORing IDS-5042 in UDP Mode. The interface is divided into several sections:

- Serial Settings**: Includes a tab for "Service Mode" where "UDP Mode" is selected.
- UDP Mode**: Contains a sub-section for "UDP Settings" with a "Listening Port" field set to "4004" and an "Auto Scan" button.
- Multilink**: A table with four rows for configuring multiple links. The first row is populated with "192.168.0.1" for "Destination Host Begin", "192.168.0.100" for "Destination Host End", and "10000" for "Sending Port". Each row includes an "Auto Scan" button.

	Destination Host Begin	to	Destination Host End	Sending Port	Auto Scan
1	192.168.0.1		192.168.0.100	10000	<input type="button" value="Auto Scan"/>
2					<input type="button" value="Auto Scan"/>
3					<input type="button" value="Auto Scan"/>
4					<input type="button" value="Auto Scan"/>

Figure 5-18 UDP mode

## Notification

Specify the events that should be noticed. The events can be noticed by E-mail, SNMP trap or system log.

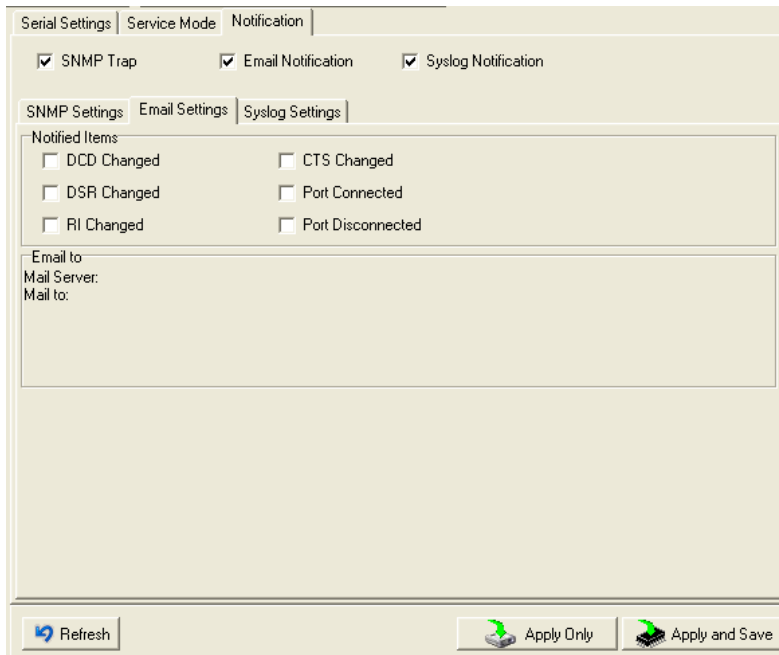

Figure 5-19 Notification

The following table describes the labels in this screen.

Label	Description
DCD changed	When DCD (Data Carrier Detect) signal changes, it indicates that the modem connection status has changed. Notification will be sent.
DSR changed	When DSR (Data Set Ready) signal changes, it indicates that the data communication equipment is powered off. A Notification will be sent.
RI changed	When RI (Ring Indicator) signal changes, it indicates that the incoming of a call. A Notification will be sent.
CTS changed	When CTS (Clear To Send) signal changes, it indicates that the transmission between computer and DCE can proceed. A notification will be sent.
Port connected	In TCP Server Mode, when the device accepts an incoming TCP connection, this event will be trigger. In TCP Client Mode, when the device has connected to the remote host, this event will be trigger. In Virtual COM Mode, Virtual COM is ready to use. A notification will be sent.



Port disconnected	<p>In TCP Server/Client Mode, when the device lost the TCP link, this event will be trigger.</p> <p>In Virtual COM Mode, When Virtual COM is not available, this event will be trigger. A notification will be sent.</p>
-------------------	--

Table 5-13 Notification

## 5.2 Configuration by Web Browser

### 5.2.1 CONNECT TO THE WEB PAGE

Step 1: Input the IP address of DS with “**https://192.168.10.2**” in the Address input box of IE.

Step 2: Click “**Yes**” button on the dialog box.



Figure 5-20 Certificate



Step 3: Input the name and password, then click "OK".

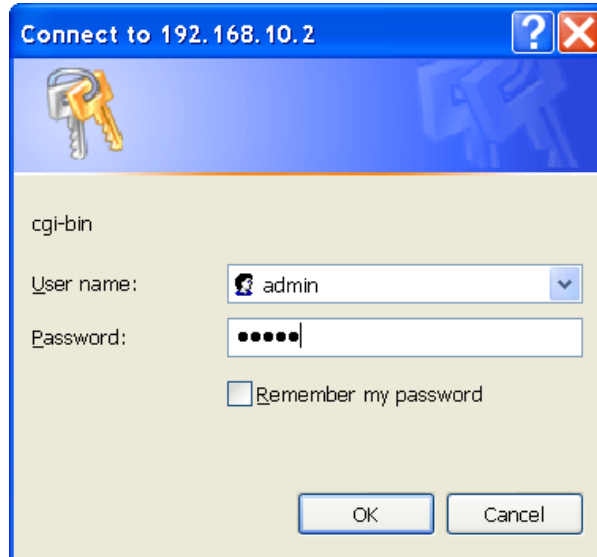

Figure 5-21 Certificate

*\*Only if password is set.*

Step 4: The system information will be shown as below.

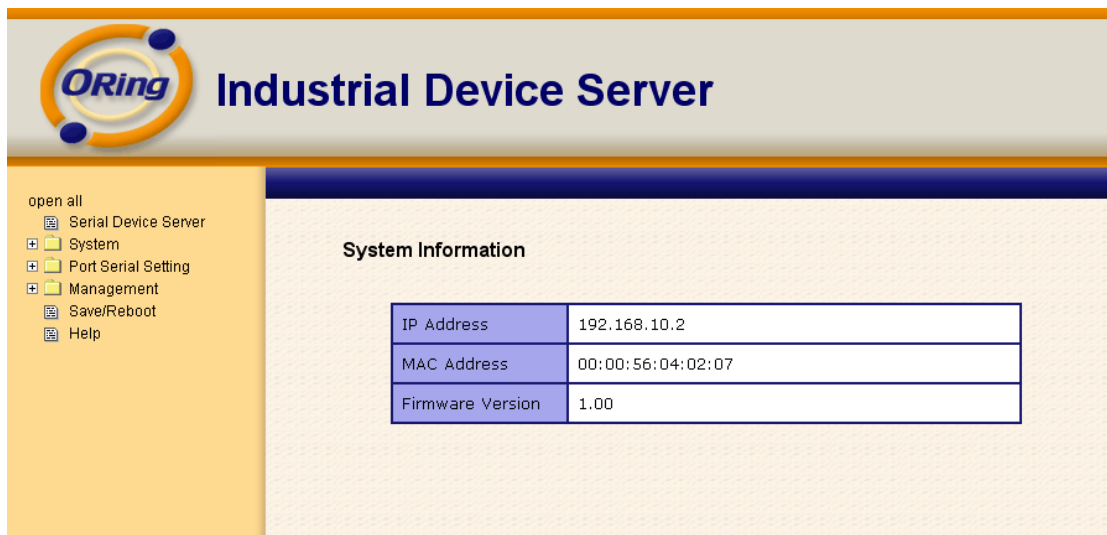

Figure 5-21 System information

## 5.2.1.1 System

### Time (SNTP)



Figure 5-22 Time (SNTP)

The following table describes the labels in this screen.

Label	Description
Name	You can set the name of DS.
SNTP	Enable the SNTP server.
Time zone	After you set the SNTP enable, select the time zone you located.
Time server	Input SNTP server domain name or IP address and Port.
Console	Telnet Console (SSH) is included for security reasons. In some cases, you may need to disable this function to prevent unauthorized access from internet. The factory default is enable.

Table 5-14 Time (SNTP)



## IP Configuration

You must assign a valid IP address for DS before attached in your network environment. Your network administrator should provide you with the IP address and related settings. The IP address must be unique and within the network (otherwise, DS will not have a valid connection to the network). You can choose from three possible “**IP configuration**” modes: Static, DHCP/BOOTP. The Factory Default IP address is “**192.168.10.2**”

The screenshot shows the web interface for the ORing Industrial Device Server. The page title is "Industrial Device Server" and the sub-page title is "IP Configuration". On the left is a navigation menu with the following items: "open all", "Serial Device Server", "System" (expanded), "Time(SNTP)", "IP Configuration", "DDNS Configuration", "User Authentication", "Port Serial Setting", "Management" (expanded), "Save/Reboot", and "Help". The main content area contains the "IP Configuration" settings:

IP Configuration	DHCP/BOOTP
IP Address	192.168.0.82
Netmask	255.255.255.0
Gateway	192.168.0.1
DNS Server 1	192.168.0.1
DNS Server 2	
Auto IP Report	
Auto Report to IP	
Auto Report to TCP Port	0
Auto Report Interval	0 seconds
Ethernet Mode	
Ethernet Mode	<input checked="" type="radio"/> Redundant <input type="radio"/> Switch

At the bottom of the form is an "Apply" button.

Figure 5-23 IP configuration

The following table describes the labels in this screen.

Label	Description
DHCP/BOOTP	Obtain the IP address automatically from DHCP server.
Static IP Address	Assigning an IP address manually.
Subnet Mask	Set the subnet mask to communicate on the network.
Gateway	Enter the IP address of the router in you network.
DNS Server	Enter the IP address of the DNS server to translate domain names into IP address.
Auto IP Report	The device server will report its status periodically. At DS-Tool->IP collection option show the device server status. The report interval is 0 indicate disable this setting (default). But you can set the other IP or Port.
<b>Switch Mode</b>	<p><b>Redundant:</b></p> <p>When the connection between master-link and LAN fails, the DS can automatically switch to another LAN port within 10mS, and still guarantees a non-stop connection</p> <p><b>Switch:</b></p> <p>Daisy Chain support to reduce usage of switch ports.</p>

Table 5-15 IP configuration

## PPPoE setting

PPPoE (Point-to-Point Protocol over Ethernet), Device can use PPPoE mode to connect the Network. Input the “**username**” and “**Password**”, then click “**Connect**” button. If the device has been connected, the “**Status**” will become the “**Link up**” and device will get an IP address from PPPoE server. Click “**Return**” button, return the “**IP Configuration**” default page.

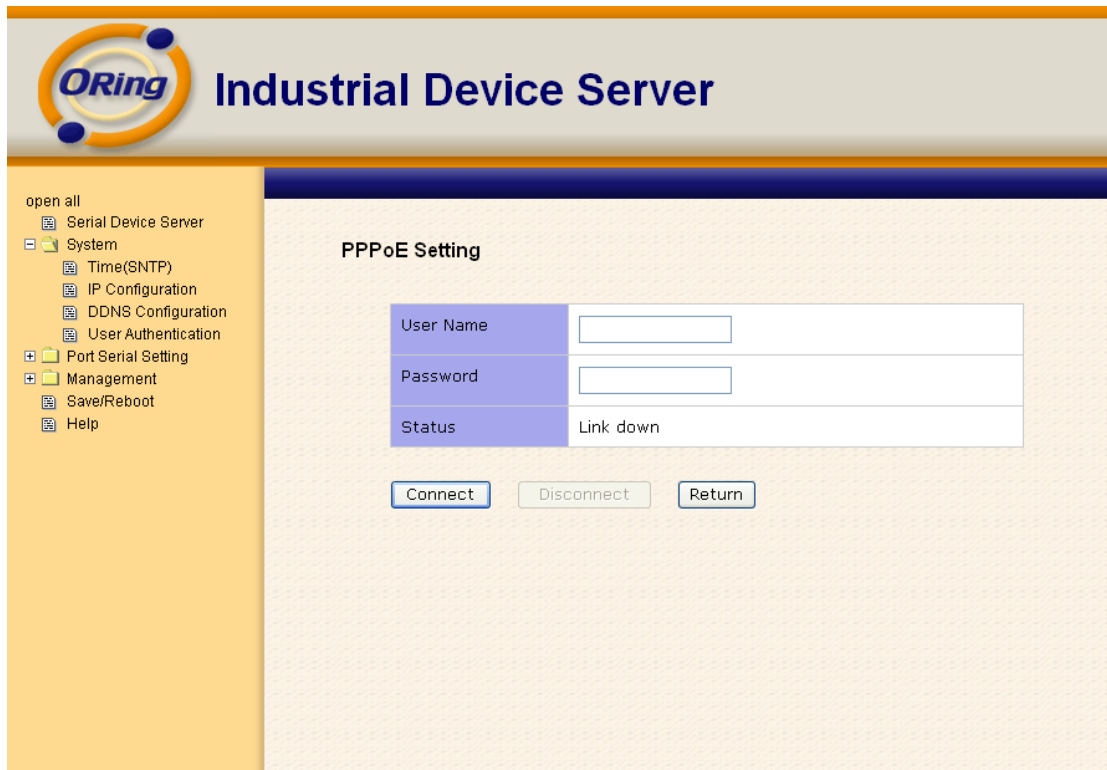

Figure 5-24 PPPoE setting.

### DDNS Configuration

The Dynamic DNS service allows you to alias a dynamic IP address to a static hostname, allowing your computer to be more easily accessed from various locations on the Internet.



Figure 5-26 DDNS setting

The following table describes the labels in this screen.

Label	Description
Service Provider	Choose the DDNS service Provider
Hostname	You must first apply an account from the DDNS service Provider such as www.dyndns.org, then register with the dynamic DNS service. Input the fixed hostname you got from the DDNS service.
Account and Password	Input the Account and Password you have registered from the DDNS service Provider.
Check WAN IP Schedule	Device will check the IP address Status at interval time you set.

Table 5-16 DDNS Setting

## Authentication

You can set the password to prevent unauthorized access from network. Input the “**Old password**” and “**New password**” to change the password. Factory default is no password.



The screenshot displays the web interface for the ORing Industrial Device Server. The page title is "Industrial Device Server". On the left, there is a navigation menu with the following items: "open all", "Serial Device Server", "System" (expanded), "Time(SNTP)", "IP Configuration", "DDNS Configuration", "User Authentication", "Port Serial Setting", "Management", "Save/Reboot", and "Help". The main content area is titled "User Authentication" and contains three input fields: "Old Password", "New Password", and "Confirm New Password". Below these fields is an "Apply" button.

Field Label	Input Type
Old Password	Text Input
New Password	Text Input
Confirm New Password	Text Input

Apply

Figure 5-27 Authentication



## 5.2.1.2 Port serial setting

### Serial configuration

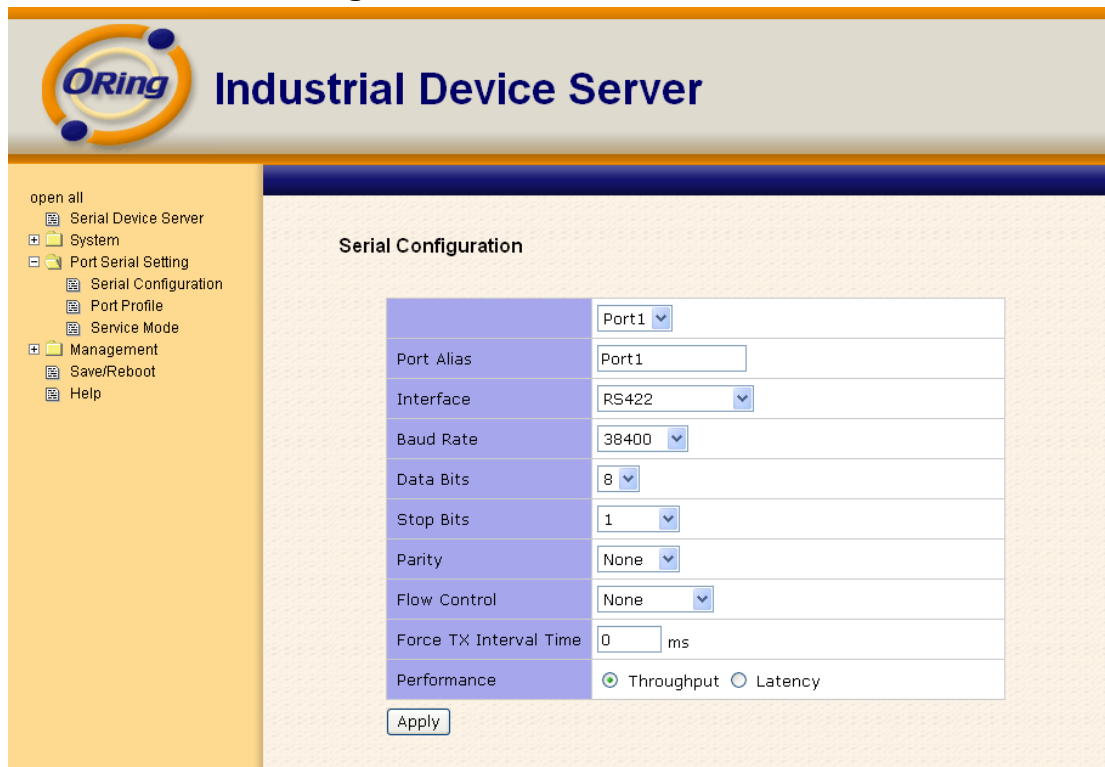

The screenshot shows the 'Serial Configuration' page of the ORing Industrial Device Server. The page has a header with the ORing logo and the title 'Industrial Device Server'. A left-hand navigation menu is visible, listing various system settings. The main content area is titled 'Serial Configuration' and contains a form with the following fields:

- Port: Port1 (dropdown)
- Port Alias: Port1 (text input)
- Interface: RS422 (dropdown)
- Baud Rate: 38400 (dropdown)
- Data Bits: 8 (dropdown)
- Stop Bits: 1 (dropdown)
- Parity: None (dropdown)
- Flow Control: None (dropdown)
- Force TX Interval Time: 0 ms (text input)
- Performance:  Throughput  Latency (radio buttons)

An 'Apply' button is located at the bottom of the form.

Figure 5-28 Serial configuration

The following table describes the labels in this screen.

Label	Description
Port Alias	Remark the port to hint the connected device.
Interface	RS422 / RS485(2-wires) / RS485(4-wires)
Baud rate	110bps/300bps/1200bps/2400bps/4800bps/9600bps/19200bps/ 38400bps/57600bps/115200bps/230400bps/460800bps
Data Bits	5, 6, 7, 8
Stop Bits	1, 2 (1.5)



Parity	No, Even, Odd, Mark, Space
Flow Control	No, XON/XOFF, RTS/CTS, DTR/DSR
Force TX Interval Time	Force TX interval time is to specify the timeout when no data has been transmitted. When the timeout is reached or TX buffer is full (4K Bytes), the queued data will be sent. 0 means disable. Factory default value is 0.
Performance	Throughput: This mode optimized for highest transmission speed. Latency: This mode optimized for shortest response time.
Apply	Activate settings on this page.

Table 5-18 Serial configuration

### Port Profile

The screenshot shows the 'Port Profile' configuration page in the ORing Industrial Device Server web interface. The left sidebar contains a navigation menu with options like 'Serial Device Server', 'System', 'Port Serial Setting', 'Serial Configuration', 'Port Profile', 'Service Mode', 'Management', 'Save/Reboot', and 'Help'. The main content area is titled 'Port Profile' and contains the following configuration fields:

- Port: Port1 (dropdown)
- Local TCP Port: 4000
- Command Port: 4001
- Mode: Serial to Ethernet
- Flush Data Buffer After: 0 ms
- Delimiter(Hex 0~ff): 1: 00 2: 00 3: 00 4: 00
- Mode: Ethernet to Serial
- Flush Data Buffer After: 0 ms
- Delimiter(Hex 0~ff): 1: 00 2: 00 3: 00 4: 00

An 'Apply' button is located at the bottom of the configuration area.

Figure 5-29 Port Profile



The following table describes the labels in this screen.

Label	Description
Serial to Ethernet	<p><b>Flush Data Buffer After:</b></p> <p>The received data will be queued in the buffer until all the delimiters are matched. When the buffer is full (4K Bytes) or after "<b>flush S2E data buffer</b>" timeout, the data will also be sent. You can set the time from 0 to 65535 seconds.</p> <p><b>Delimiter:</b></p> <p>You can define max. 4 delimiters (00~FF, Hex) for each way. The data will be hold until the delimiters are received or the option "<b>Flush Serial to Ethernet data buffer</b>" times out. 0 means disable. Factory default is 0</p>
Ethernet to serial	<p><b>Flush Data Buffer After:</b></p> <p>The received data will be queued in the buffer until all the delimiters are matched. When the buffer is full (4K Bytes) or after "<b>flush E2S data buffer</b>" timeout, the data will also be sent. You can set the time from 0 to 65535 seconds.</p> <p><b>Delimiter:</b></p> <p>You can define max. 4 delimiters (00~FF, Hex) for each way. The data will be hold until the delimiters are received or the option "<b>Flush Ethernet to Serial data buffer</b>" times out. 0 means disable. Factory default is 0</p>

Table 5-18 Port Profile

## Service Mode – Virtual COM Mode

In Virtual COM Mode, the driver establishes a transparent connection between host and serial device by mapping the Port of the serial server serial port to local COM port on the host computer. Virtual COM Mode also supports up to 5 simultaneous connections, so that multiple hosts can send or receive data by the same serial device at the same time.



Figure 5-30 Virtual COM mode

The following table describes the labels in this screen.

Label	Description
Data Encryption	Use SSL to encrypt data.
Idle Timeout	When serial port stops data transmission for a defined period of time (Idle Timeout), the connection will be closed and the port will be freed and try to connect with other hosts. 0 indicate disable this function. Factory default value is 0. If Multilink is configured, only the first host connection is effective for this setting.

Alive Check	The serial device will send TCP alive-check package in each defined time interval (Alive Check) to remote host to check the TCP connection. If the TCP connection is not alive, the connection will be closed and the port will be freed. 0 indicate disable this function. Factory default is 0.
Max Connection	The number of Max connection can support simultaneous connections are 5, default values is 1.

Table 5-19 Virtual COM mode

\*Not allowed to mapping Virtual COM from web

## Service Mode – TCP Server Mode

In TCP Server Mode, DS is configured with a unique Port combination on a TCP/IP network. In this case, DS waits passively to be contacted by the device. After the device establishes a connection with the serial device, it can then proceed with data transmission. TCP Server mode also supports up to 5 simultaneous connections, so that multiple device can receive data from the same serial device at the same time.



Service Mode	
	Port1
Data Encryption	<input type="radio"/> Enable <input checked="" type="radio"/> Disable
Service Mode	TCP Server Mode
Telnet Negotiation	<input type="radio"/> Enable <input checked="" type="radio"/> Disable
TCP Server Port	4000
Idle Timeout	0 (0~65535)seconds
Alive Check	40 (0~65535)seconds
Max Connection	1 max. connection(1~5)

Apply

Figure 5-31 TCP Server Mode



The following table describes the labels in this screen.

Label	Description
Data Encryption	Use SSL to encrypt data.
Telnet Negotiation	Full Telnet command / symbol compatible
TCP Server Port	Set the port number for data transmission.
Idle Timeout	When serial port stops data transmission for a defined period of time (Idle Timeout), the connection will be closed and the port will be freed and try to connect with other hosts. 0 indicate disable this function. Factory default value is 0. If Multilink is configured, only the first host connection is effective for this setting.
Alive Check	The serial device will send TCP alive-check package in each defined time interval (Alive Check) to remote host to check the TCP connection. If the TCP connection is not alive, the connection will be closed and the port will be freed. 0 indicate disable this function. Factory default is 0.
Max Connection	The number of Max connection can support simultaneous connections are 5, default values is 1.

*Table 5-20 TCP server mode*

### **Service Mode – TCP Client Mode**

In TCP Client Mode, device can establish a TCP connection with server by the method you set (Startup or any character). After the data has been transferred, device can disconnect automatically from the server by using the TCP alive check time or Idle timeout settings.



The screenshot shows the 'Service Mode' configuration page for 'TCP Client Mode'. The interface includes a sidebar menu on the left with options like 'Serial Device Server', 'System', 'Port Serial Setting', 'Serial Configuration', 'Port Profile', 'Service Mode', 'Management', 'Save/Reboot', and 'Help'. The main content area is titled 'Service Mode' and contains the following settings:

- Port: Port1
- Data Encryption:  Enable  Disable
- Service Mode: TCP Client Mode
- Destination Host: [ ] : 4000
- Idle Timeout: 0 (0~65535)seconds
- Alive Check: 420 (0~65535)seconds
- Connect on:  Startup  Any Character
- Connect Mode:  Auto  Manual [Connect] [Close]
- Destination Host Port:
 

1.	[ ]	65535
2.	[ ]	65535
3.	[ ]	65535
4.	[ ]	65535

An 'Apply' button is located at the bottom of the configuration area.

Figure 5-32 TCP client mode

The following table describes the labels in this screen.

Label	Description
Data Encryption	Use SSL to encrypt data.
Destination Host	Set the IP address of host and the port number of data port. .
Idle Timeout	When serial port stops data transmission for a defined period of time (Idle Timeout), the connection will be closed and the port will be freed and try to connect with other hosts. 0 indicate disable this function. Factory default value is 0. If Multilink is configured, only the first host connection is effective for this setting.
Alive Check	The serial device will send TCP alive-check package in each defined time interval (Alive Check) to remote host to check the TCP connection. If the TCP connection is not alive, the connection will be closed and the port will be freed. 0 indicate disable this function. Factory default is 0.



Connect on Startup	The TCP Client will build TCP connection once the connected serial device is started.
Connect on Any Character	The TCP Client will build TCP connection once the connected serial device starts to send data.

Table 5-21 TCP client mode

### Service Mode – UDP Client Mode

Compared to TCP communication, UDP is faster and more efficient. In UDP mode, you can Uni-cast or Multi-cast data from the serial device server to host computers, and the serial device can also receive data from one or multiple host

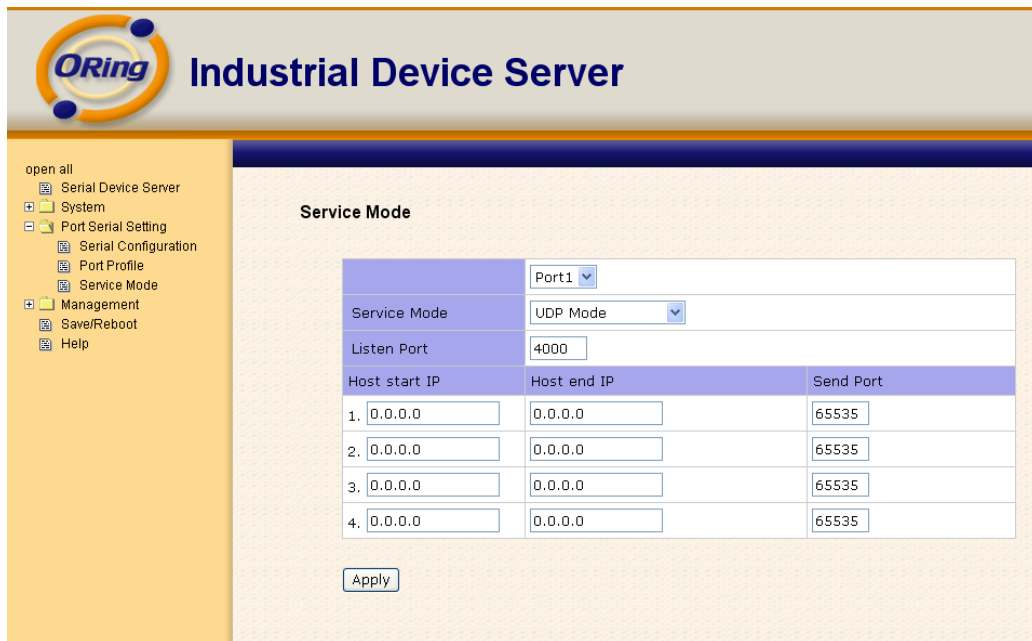

Figure 5-33 UDP client mode



### 5.2.1.3 Management

#### Access IP Control

Access IP Control Settings allow you to add or block the remote host IP addresses to prevent unauthorized access. If host's IP address is in the accessible IP table, then the host will be allowed to access the DS. You can choose one of the following cases by setting the parameter.

1. Only one host with a special IP address can access the device server, "**IP address /255.255.255.255**" (e.g., "**192.168.0.1/255.255.255.255**").
2. Hosts on a specific subnet can access the device server. "**IP address/255.255.255.0**" (e.g., "**192.168.0.2/255.255.255.0**")
3. Any host can access the device server. Disable this function by un-checking the "**Enable IP Filter**" checkbox



## Industrial Device Server

open all

- Serial Device Server
- System
- Port Serial Setting
- Management
  - Access IP Control
  - SMTP/SNMP Conf.
  - System Event Conf.
- Save/Reboot
- Help

### Access IP Control List

Enable IP Filtering (Not check this option will allow any IP to have assessibility)

No.	Activate the IP	IP Address	Netmask
1	<input type="checkbox"/>	<input type="text"/>	<input type="text"/>
2	<input type="checkbox"/>	<input type="text"/>	<input type="text"/>
3	<input type="checkbox"/>	<input type="text"/>	<input type="text"/>
4	<input type="checkbox"/>	<input type="text"/>	<input type="text"/>
5	<input type="checkbox"/>	<input type="text"/>	<input type="text"/>
6	<input type="checkbox"/>	<input type="text"/>	<input type="text"/>
7	<input type="checkbox"/>	<input type="text"/>	<input type="text"/>
8	<input type="checkbox"/>	<input type="text"/>	<input type="text"/>
9	<input type="checkbox"/>	<input type="text"/>	<input type="text"/>
10	<input type="checkbox"/>	<input type="text"/>	<input type="text"/>
11	<input type="checkbox"/>	<input type="text"/>	<input type="text"/>
12	<input type="checkbox"/>	<input type="text"/>	<input type="text"/>
13	<input type="checkbox"/>	<input type="text"/>	<input type="text"/>
14	<input type="checkbox"/>	<input type="text"/>	<input type="text"/>
15	<input type="checkbox"/>	<input type="text"/>	<input type="text"/>
16	<input type="checkbox"/>	<input type="text"/>	<input type="text"/>

*Figure 5-34 Access IP*

## SMTP/SNMP Conf

Email Server configuration includes the mail server's IP address or domain. If the authentication is required, specify your name and password. There are 4 Email addresses that you can specify to receive the notification.

SNMP Server configuration includes the SNMP Trap Server IP address, Community, Location and Contact. There are 4 SNMP addresses you can specify to receive the notification.

SysLog server configuration includes the server IP and server Port. This option need to use with DS-Tool.



The screenshot displays the 'SMTP/SNMP Configuration' page within the ORing Industrial Device Server web interface. The interface features a sidebar menu on the left with the following items: 'open all', 'Serial Device Server', 'System', 'Port Serial Setting', 'Management', 'Access IP Control', 'SMTP/SNMP Conf.', 'System Event Conf.', 'Save/Reboot', and 'Help'. The main configuration area is titled 'SMTP/SNMP Configuration' and contains the following sections:

- E-mail Settings:**
  - SMTP Server: [Text Input] Port: [Text Input]
  - My server requires authentication
  - User Name: [Text Input]
  - Password: [Text Input]
  - E-mail Sender: [Text Input]
  - E-mail Address 1: [Text Input]
  - E-mail Address 2: [Text Input]
  - E-mail Address 3: [Text Input]
  - E-mail Address 4: [Text Input]
- SNMP Trap Server:**
  - SNMP Server 1: [Text Input]
  - SNMP Server 2: [Text Input]
  - SNMP Server 3: [Text Input]
  - SNMP Server 4: [Text Input]
  - Community: [Text Input]

Figure 5-35 SMTP / SNMP conf

## System Event Conf

Specify the events that should be notified to the administrator. The events can be alarmed by E-mail, SNMP trap, or system log.



Device Event Notification			
Hardware Reset (Cold Start)	<input type="checkbox"/> SMTP Mail	<input type="checkbox"/> SNMP Trap	<input type="checkbox"/> Syslog
Software Reset (Warm Start)	<input type="checkbox"/> SMTP Mail	<input type="checkbox"/> SNMP Trap	<input type="checkbox"/> Syslog
Login Failed	<input type="checkbox"/> SMTP Mail	<input type="checkbox"/> SNMP Trap	<input type="checkbox"/> Syslog
IP Address Changed	<input type="checkbox"/> SMTP Mail	<input type="checkbox"/> SNMP Trap	<input type="checkbox"/> Syslog
Password Changed	<input type="checkbox"/> SMTP Mail	<input type="checkbox"/> SNMP Trap	<input type="checkbox"/> Syslog
Access IP Blocked	<input type="checkbox"/> SMTP Mail	<input type="checkbox"/> SNMP Trap	<input type="checkbox"/> Syslog
Redundant Power Changed	<input type="checkbox"/> SMTP Mail	<input type="checkbox"/> SNMP Trap	<input type="checkbox"/> Syslog
Redundant Ethernet Changed	<input type="checkbox"/> SMTP Mail	<input type="checkbox"/> SNMP Trap	<input type="checkbox"/> Syslog
Port Event Notification		Port1	
DCD Changed	<input type="checkbox"/> SMTP Mail	<input type="checkbox"/> SNMP Trap	<input type="checkbox"/> Syslog
DSR Changed	<input type="checkbox"/> SMTP Mail	<input type="checkbox"/> SNMP Trap	<input type="checkbox"/> Syslog
RI Changed	<input type="checkbox"/> SMTP Mail	<input type="checkbox"/> SNMP Trap	<input type="checkbox"/> Syslog
CTS Changed	<input type="checkbox"/> SMTP Mail	<input type="checkbox"/> SNMP Trap	<input type="checkbox"/> Syslog
Port Connected	<input type="checkbox"/> SMTP Mail	<input type="checkbox"/> SNMP Trap	<input type="checkbox"/> Syslog
Port Disconnected	<input type="checkbox"/> SMTP Mail	<input type="checkbox"/> SNMP Trap	<input type="checkbox"/> Syslog
Fault Event Notification and Fault LED/Relay			
Power 1 Fault	<input type="checkbox"/> SMTP Mail	<input type="checkbox"/> SNMP Trap	<input type="checkbox"/> Syslog <input type="checkbox"/> Fault LED/Relay
Power 2 Fault	<input type="checkbox"/> SMTP Mail	<input type="checkbox"/> SNMP Trap	<input type="checkbox"/> Syslog <input type="checkbox"/> Fault LED/Relay
Eth1 Link Down	<input type="checkbox"/> SMTP Mail	<input type="checkbox"/> SNMP Trap	<input type="checkbox"/> Syslog <input type="checkbox"/> Fault LED/Relay
Eth2 Link Down	<input type="checkbox"/> SMTP Mail	<input type="checkbox"/> SNMP Trap	<input type="checkbox"/> Syslog <input type="checkbox"/> Fault LED/Relay

Figure 5-36 SMTP / SNMP conf

The following table describes the labels in this screen.

Label	Description
Hardware Reset (Cold	This refers to starting the system from power off (contrast this with warm start). When



Start)	performing a cold start, DS will automatically issue an Auto warning message by sending E-mail, log information or an SNMP trap after booting.
Software Reset (Warm Start)	This refers to restart the computer without turning the power off. When performing a warm start, DS will automatically send an E-mail, log information or SNMP trap after reboot.
Login Failed	When an unauthorized access from the Console or Web interface, a notification will be sent.
IP Address Changed	When IP address of device changed, a notification will be sent.
Password Changed	When password of device changed, a notification will be sent.
Access IP Blocked	When the host accesses the device with blocked IP addresses, a notification will be sent.
Redundant Power Change	When status of power changed, a notification will be sent.
Redundant Ethernet Change	When status of Ethernet port changed, a notification will be sent.
DCD changed	When DCD (Data Carrier Detect) signal changes, it indicates that the modem connection status has been changed. A Notification will be sent.
DSR changed	When DSR (Data Set Ready) signal changes, it indicates that the data communication equipment is powered off. A Notification will be sent.
RI changed	When RI (Ring Indicator) signal changes, it indicates an incoming call. Notification will be sent.
CTS changed	When CTS (Clear To Send) signal changes, it indicates that the transmission between computer and DCE can proceed. A notification will be sent.
Port connected	In TCP Server Mode, when the device accepts an incoming TCP connection, this event will be trigger. In TCP Client Mode, when the device has connected to the remote host, this event will be trigger. In Virtual COM Mode, Virtual COM is ready to use. A notification will be sent.
Port disconnected	In TCP Server/Client Mode, when the device lost the TCP link, this event will be trigger. In Virtual COM Mode, When Virtual COM is not available, this event will be trigger. A notification will be sent.
Power 1 Fault	When Power 1 Fault, a notification will be sent and the Fault LED will be turned on.
Power 2 Fault	When Power 2 Fault, a notification will be sent and Fault LED will be turned on.



Eth1 link down	When Eth1 link down, a notification will be sent and Fault LED will be turned on.
Eth2 link down	When Eth2 link down, a notification will be sent and Fault LED will be turned on.

Table 5-22 System event conf

### 5.2.1.4 Save/Reboot



Figure 5-37 Save / Reboot

The following table describes the labels in this screen.

Label	Description
Factory Default	Load default configuration except settings of Network. If you want load all factory default, you should press "Reset" button about the five seconds on the device (Hardware restore).
Restore Configuration	Restore the previous exported configuration.
Backup Configuration	Export the current configuration to a file.
Upgrade Firmware	Upgrade to a new firmware with specified file.
Reboot Device	Reboot the device server (warm start).

Table 5-23 Save / Reboot

## 5.3 Configuration by SSH Console

### 5.3.1 Connect to DS

You can use SSH Tool (e.g., PUTTY) to access SSH console of DS. The SSH console interface is shown below.

```

login as: admin
admin@192.168.0.75's password:
*****
*** ORING Industrial Serial Device Server Commander ***
*****
Input System Password: ****
Password confirmed. Starting Main Menu.
-----
[ORING Industrial Serial Device Server Commander]
1. Overview
2. General Settings
3. Network Settings
4. Ports settings
5. Security(Accessible IP) Settings
6. Notification(Auto Warning) Settings
7. Wireless config setting
8. Wireless network setting
A. DDNS setting
C. Change Password
L. Load Factory Default
S. Save configuration
R. Reboot
Q. Exit & Logout
Select one function (1-6,C,L,S,R,Q): █
  
```

Figure 5-38 SSH







# Technical Specifications

<b>Network Interface</b>	
Ethernet	2x 10/100Base-T(X) which support Redundant Dual Ethernet or Switch Mode support. Auto-recover less than 10ms
connector	RJ-45
Protection	Built-in1.5KV magnetic isolation
Protocols	ICMP, IP, TCP, UDP, DHCP, BOOTP, ARP/RARP, DNS, SNMP MIB II, HTTPS, SSH
<b>Serial Interface</b>	
Interface	IDS-5042/IDS-5042+: 4x RS232 / RS422 / 4(2)-Wire RS485. Which can be configured by DS-Tool  IDS-5042-I+: 4x RS422 / 4(2)-Wire RS485. Which can be configured by DS-Tool
Connector	IDS-5042/IDS-5042+: Male DB9 IDS-5042-I+: 5 pin terminal block
Serial Baud Rate	110 bps to 460.8 Kbps
Data Bits	5, 6, 7, 8
Parity	odd, even, none, mark, space
Stop Bits	1, 1.5, 2
RS-232 signals	TxD, RxD, RTS, CTS, DTR, DSR, DCD, RI, GND (IDS-5042/IDS-5042+)
RS-422 signals	Tx+,Tx-, Rx+, Rx-,GND
RS-485 (4 wire) signals	Tx+,Tx-, Rx+, Rx-,GND
RS-485 (2 wire) signals	Data+, Data-,GND



Flow control	XON/XOFF, RTS/CTS, DTR/DSR
Serial Line Protection	Built-in15KV ESD protection 2KV DC isolation for each port (IDS-5042-I+ only)
LED Indicators	<p>PWR P.O.E.(1)(2) / Ready:</p> <p>1) Red On: Power is on and booting up. Red Blinking: Indicates an IP conflict, or DHCP or BOOTP server did not respond properly.</p> <p>2) Green On: Power is on and functioning normally. Green Blinking: Located by Administrator.</p> <p>ETH1(2) Link / ACT:</p> <p>Amber ON/Blinking: 10 Mbps Ethernet Green ON/Blinking:100 Mbps Ethernet</p> <p>Serial TX / RX LEDES:</p> <p>Red: Serial port is receiving data Green: Serial port is transmitting data. Fault: Fault alarm (Red)</p>
<b>Power Requirements</b>	
Power Input	PWR1/2: 12~48VDC in 6-pin Terminal Block
Reverse Polarity Protection	Present at terminal block
Power Consumption	7 Watts MAX
<b>Software Utility</b>	
Utility	<p>DS-Tool for Windows NT/2000/XP/ 2003/VISTA which include</p> <p>Device discovery</p> <p>Auto IP report</p> <p>Device setting (run-time change, no rebooting)</p> <p>Access control list</p> <p>Group setting</p> <p>Device monitoring</p> <p>Serial port monitoring</p> <p>Log info</p> <p>Group Firmware update</p>



Serial Mode	Virtual Com / TCP Server / TCP Client / UDP /Serial Tunnel TCP Alive Check Timeout Inactivity Timeout Delimiter for Data Packing Force TX Timeout for Data Packing
Multiple Link	5 Hosts simultaneous connection: Virtual Com / TCP server / TCP Client / UDP
VCOM Driver	Windows NT/2000/XP/2003/VISTA
Configuration	Web HTTPS console, SSH console, DS-Tool for Windows NT/2000/XP/VISTA
<b>Environmental</b>	
Operating Temperature	-10 to 60°C (14 to 140°F)
Operating Humidity	5% to 95%(Non-condensing)
Storage Temperature	-40 to 85°C (-40 to 185°F)
<b>Mechanical</b>	
Dimensions(W x D x H)	52mm(W)x106mm(D)x144mm(H)
Casing	IP-30 protection
<b>Regulatory Approvals</b>	
Shock	IEC 60068-2-27
Free Fall	IEC 60068-2-32
Vibration	IEC 60068-2-6
EMI	FCC Part 15, CISPR (EN55022) class A
EMS	EN61000-4-2 (ESD), EN61000-4-3 (RS), EN61000-4-4 (EFT), EN61000-4-5 (Surge), EN61000-4-6 (CS).
Warranty	5 years