



## I-7561/I-7561U

USB to Isolated RS-232/422/485 Converter

### Features

- Fully Compliant with the USB 1.1/2.0/3.0
- 3000 V<sub>DC</sub> Isolation Protection on the RS-232/422/485 side
- ESD Protection for the RS-232/422/485 Data Line
- No External Power Supply required
- Automatic RS-485 Direction Control
- Transmission speed up to 921.6 kbps (For I-7561U)



### Introduction

The I-7561/I-7561U is a cost-effective module for transferring serial data via USB. It allows you to connect your serial devices to systems that use a USB interface. Connecting the I-7561/I-7561U to a PC, you get one RS-232/422/485 port. Like the I-7520A, the I-7561 contains "Self-Tuner" chip auto-tunes the Baud Rate and data format to the RS-485 network. The I-7561/I-7561U module derives its power from the USB port and doesn't need any power adapter.

### Software

I-7561 Driver	Windows 98/ME/2000/XP/Vista (32/64-bit)/7 (32/64-bit)/10 (64-bit)/Linux
I-7561U Driver	Windows 7 (32/64-bit)/8 (32/64-bit)/10 (64-bit)/11 (64-bit)/Linux

### System Specifications

Models	I-7561	I-7561U
<b>Interface</b>		
USB	Fully Compliant with the USB 1.1/2.0/3.0	
Serial Interface	RS-232	The RS-232, RS-422 and RS-485 cannot be used simultaneously <ul style="list-style-type: none"> <li>• TxD, RxD, GND</li> <li>• TxD+, TxD-, RxD+, RxD-</li> <li>• Data+, Data-</li> </ul>
	RS-422	
	RS-485	
RS-422/485 Transmission Distance	Max. 1,200 m at 9.6 kbps; Max. 400 m at 115.2 kbps (Belden 9841 2P twisted-pair cable, if different cables are used, the transmission distance may change)	
Self-Tuner Asic Inside (RS-485)	Yes	
Speed	300 ~ 115200 bps	300 ~ 921.6 kbps
Connector	RS-232/422/485	Removable 10-Pin Terminal Block
	USB	Type B
Cable Included	CA-USB18 (1.8 m Cable) x 1	
<b>LED Indicators</b>		
Power	Yes	
<b>Power</b>		
Input Voltage Range	+5 V <sub>DC</sub> from USB	
Power Consumption	0.5 W	
<b>Mechanical</b>		
Casing	Plastic	
Dimensions (W x L x H)	72 mm x 35 mm x 115 mm	
Installation	DIN-Rail Mounting	
<b>Environment</b>		
Operating Temperature	-25 °C ~ +75 °C	
Storage Temperature	-30 °C ~ +75 °C	
Humidity	10 ~ 90% RH, non-condensing	

## Applications

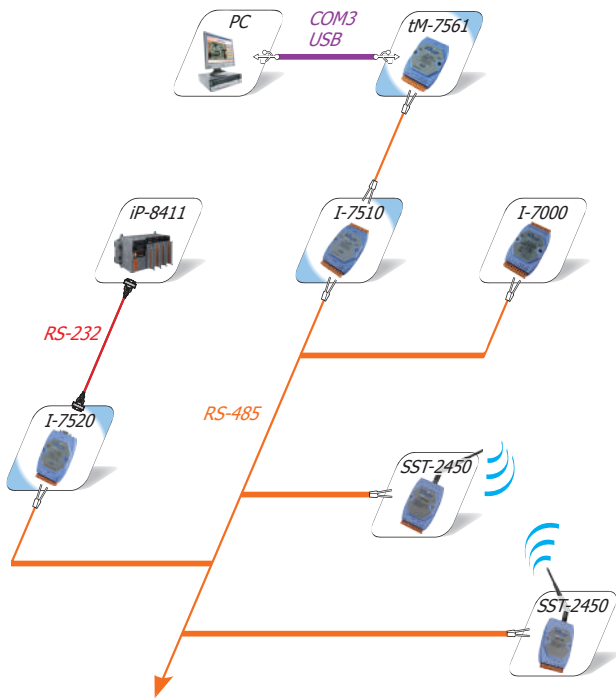

## Internal I/O Structure

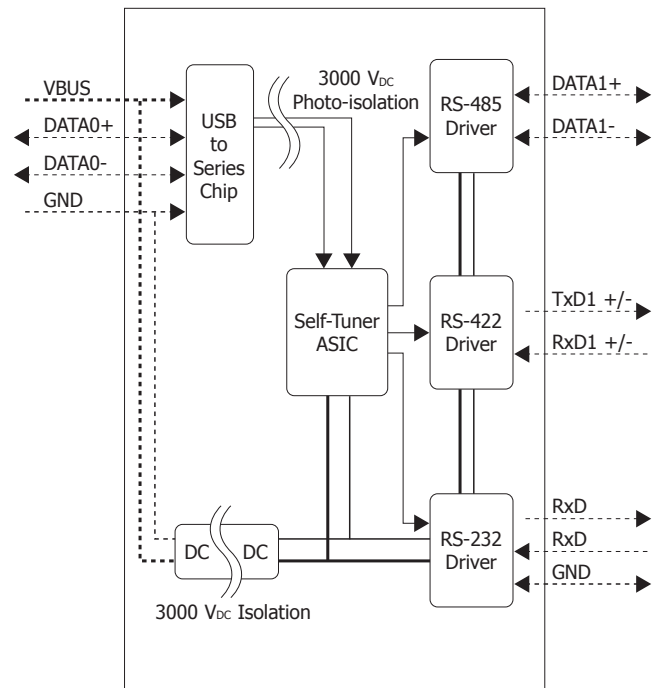

## Dimensions (Units: mm)

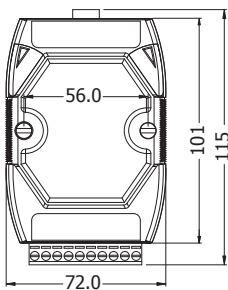

Front View

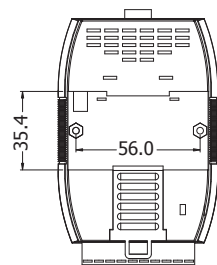

Rear View

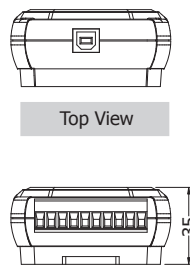

Bottom View

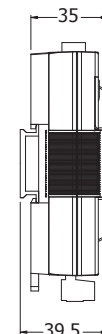

DIN-Rail Mounting Bracket

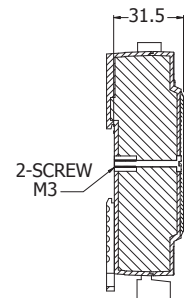

Side View

## Pin Assignments



Terminal No.	Pin Assignment
RS-485	01 DATA+
	02 DATA-
RS-422/485	03 TxD+
	04 TxD-
	05 RxD+/DATA2+
	06 RxD-/DATA2-
RS-232	07 TxD
	08 RxD
	09 (B)GND
	10 (B)GND

## Ordering Information

I-7561 CR	USB to Isolated RS-232/422/485 Converter with CA-USB18 Cable (Blue Cover) (RoHS)
I-7561-G CR	USB to Isolated RS-232/422/485 Converter with CA-USB18 Cable (Gray Cover) (RoHS)
I-7561U CR	High-speed USB to Isolated RS-232/422/485 Converter with CA-USB18 Cable (Gray Cover) (RoHS)

## Accessories

USB-2560 CR	4-port Industrial USB 2.0 Hub (RoHS) Includes CA-USB18 Cable
-------------	---