

DM-F Series

12.1"~24" DM-F IP65 Industrial Monitor

New



Features

- Robust IP65 aluminum front bezel
- Aesthetic ultra-thin bezel for seamless panel mount installation
- Wide range 9V~36V DC input
- HDMI/DisplayPort/VGA flexible video input solution
- Projected capacitive multi-touch/ resistive single touch options
- Wide temperature support



Specifications

Model		DM-F12A	DM-F15A	DM-F17A	DM-F22A	DM-F24A
LCD	LCD Display	12" (4:3)	15" (4:3)	17" (5:4)	21.5" (16:9)	24" (16:9)
	Max. Resolution	1024(W) x 768(H)	1024(W) x 768(H)	1280(W) x 1024(H)	1920(W) x 1080(H)	1920(W) x 1080(H)
	Brightness (cd/m ²)	600	400	350	250	250
	Contrast Ratio	700 : 1	700 : 1	1000 : 1	1000 : 1	3000 : 1
	LCD Color	16.2M	16.2M	16.7M	16.7M	16.7M
	Pixel Pitch (mm)	0.24 x 0.24	0.29 x 0.29	0.26 x 0.26	0.25 x 0.25	0.28 x 0.28
	Viewing Angle (H-V)	160° / 140°	160° / 140°	170° / 160°	170° / 160°	178°/178°
	Backlight MTBF (Hrs)	50000	50000	50000	30000	30000
Touchscreen & Controller		Resistive type 5-wire single touch window/ Penmount 6000 Projected capacitive 2-point touch window/ EETI EXC7200			Projected capacitive 2-point touch window/ EETI EXC7200	Projected capacitive 2-point touch window/ EETI EXC7200
I/O Ports		1 x VGA (DB-15) 1 x HDMI 1 x DisplayPort 1.1 1 x USB 2.0 (touch) 1 x RS-232 (touch) [reserved for resistive touch ATO] 1 x Lockable 9V-36V DC jack 1 x 9V-36V terminal block				
OSD	OSD Button	7-key membrane OSD keypad				
	Smart OSD Software	Smart OSD Software				
Physical	Construction Material	Aluminum front cover and sheet metal rear cover				
	Mounting	Panel Mount/ Rack Mount/ 100*100 VESA Mount			Panel Mount/ 100*100 VESA Mount	
	Enclosure Color	Black C				
	Dimensions (mm)	262.2 x 322.2 x 40.5	303 x 378.5 x 43.2	341.4 x 408.4 x 49.3	350.4 x 550.4 x 49.1	382 x 600 x 49.4
	Cutout Dimensions (mm)	234.8 x 303.8	284.6 x 68.1	323 x 398	340 x 532	358.6 x 578.6
	Weight (Net/Gross)	2.7 / 4.9	3.5 / 5.5	4.4 / 7.1	6.3 / 9.6	7.6 / 10.9
Environment	Operating Temperature (with air flow)	-20°C ~ 60°C			-10°C ~ 50°C	
	Storage Temperature	-20°C ~ 70°C			-20°C ~ 60°C	
	Humidity	10% to 95% (non-condensing)				
	IP Level	IP 65 compliant front panel				
	Safety and EMC	CE & FCC certified				
Power	Power Adapter	63040-010060-040-RS 12V 60W with lock (ATO by option)				
	Power Input	9V~36V DC				

1
IEIMobile Solutions

2
Automation Panel Solutions

3
PACSmate Medical Solutions

4
Optional Peripherals

DM-F12A/15A/17A

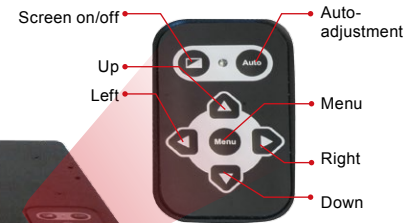
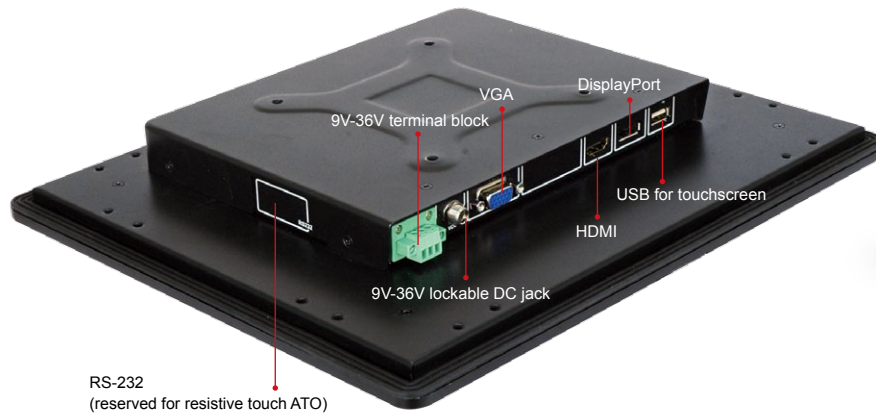

DM-F22A/24A

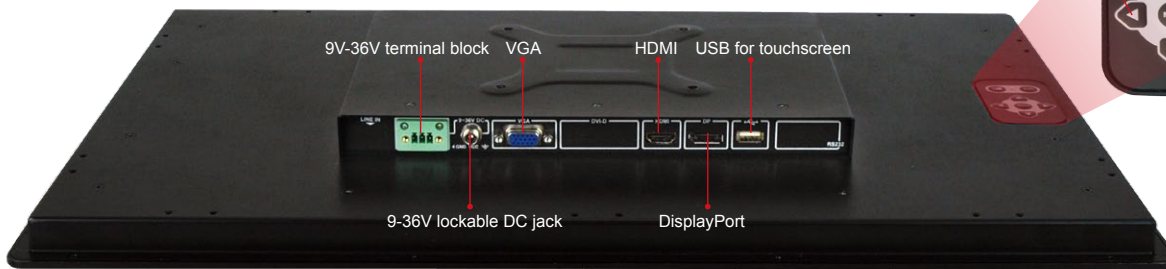

Options

Item	DM-F12A	DM-F15A	DM-F17A	DM-F22A	DM-F24A
Power Adapter	63040-010060-040-RS (Meet PSE)				
Arm	ARM-11-RS	ARM-31-RS	ARM-31-RS	ARM-31-RS	ARM-31-RS
Stand	STAND-A12-RS	STAND-A19-RS STAND-B19-RS	STAND-C19-RS STAND-A21-R10	STAND-C19-RS STAND-A21-R10	STAND-C19-RS STAND-A21-R10
Wall Mount Kit	WK-190MS-R10				
Panel Mount Kit	FPK-01-R10		FPK-02-R10		FPK-03-R10
Rack Mount Kit	FRK12-R10	FRK15-R10	FRK17-R10	N/A	
Cable Cover	N/A	DM-F-CC01-R10		DM-F-CC02-R10	
RS-232 Touch Cable Kit	DM-F-COMKIT-R10			N/A	
HDMI Cable	32012-000800-100-RS				
DisplayPort Cable	32004-000200-100-RS				

Packing List

Item	P/N	Q'ty	Description
Utility CD		1	Drivers and user manual
Touch Pen	43125-0002C0-00-RS	1	Resistive touch only
USB Cable	32001-006100-100-RS	1	For touch screen
VGA Cable	32000-036200-RS	1	

Ordering Information

PN	Description
DM-F12A/R-R11	12" 600 cd/m ² XGA LCD monitor, Aluminum front panel, Black color, W/ USB resistive touch screen, 9 ~36V DC input, R11
DM-F12A/PC-R11	12" 600 cd/m ² XGA LCD monitor, Aluminum front panel, Black color, W/ USB projected capacitive touch screen, 9 ~36V DC input, R11
DM-F15A/R-R11	15" 400 cd/m ² XGA LCD monitor, Aluminum front panel, Black color, W/ USB resistive touch screen, 9 ~36V DC input, R11
DM-F15A/PC-R11	15" 400 cd/m ² XGA LCD monitor, Aluminum front panel, Black color, W/ USB projected capacitive touch screen, 9 ~36V DC input, R11
DM-F17A/R-R11	17" 350 cd/m ² SXGA LCD monitor, Aluminum front panel, Black color, W/ USB resistive touch screen, 9 ~36V DC input, R11
DM-F17A/PC-R11	17" 350 cd/m ² SXGA LCD monitor, Aluminum front panel, Black color, W/ USB projected capacitive touch screen, 9 ~36V DC input, R11
DM-F22A/PC-R11	21.5" 250 cd/m ² FHD LCD monitor, Aluminum front panel, Black color, W/ USB projected capacitive touch screen, 9 ~36V DC input, R11
DM-F24A/PC-R10	24" 250 cd/m ² FHD LCD monitor, Aluminum front panel, Black color, W/ USB projected capacitive touch screen, 9 ~36V DC input, R10

DM-F12A Dimensions

(Unit: mm)

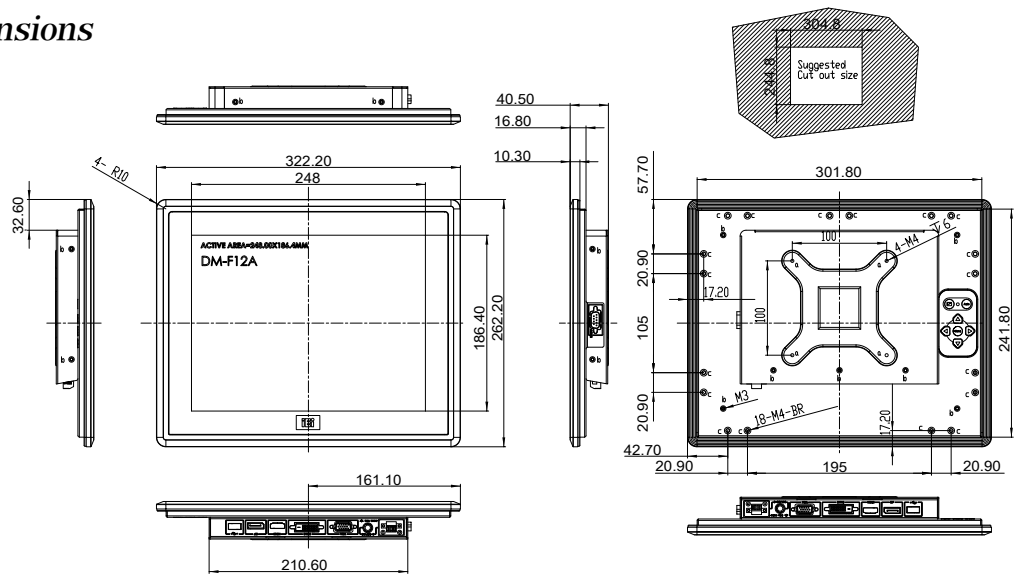

DM-F15A Dimensions

(Unit: mm)

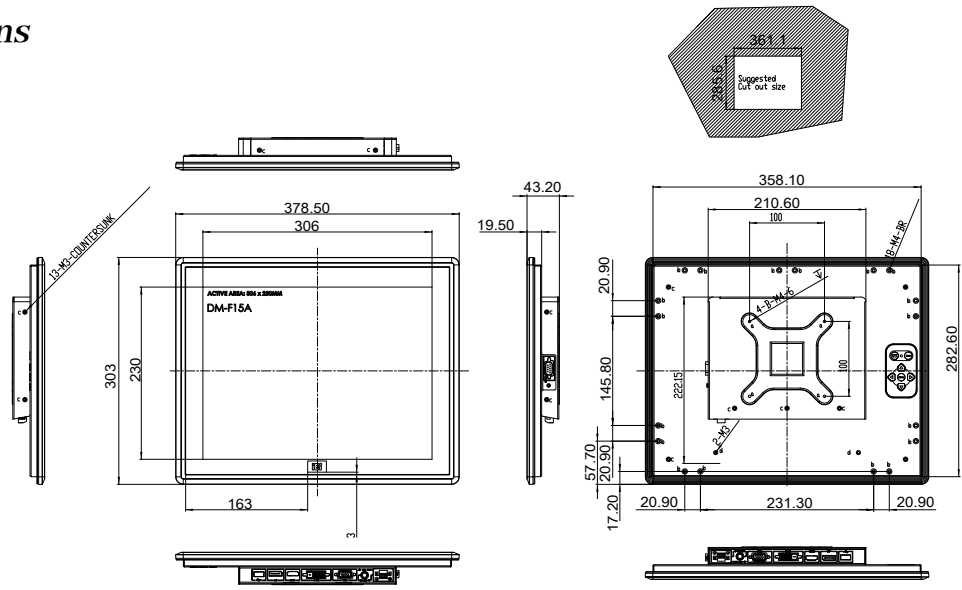

DM-F17A Dimensions

(Unit: mm)

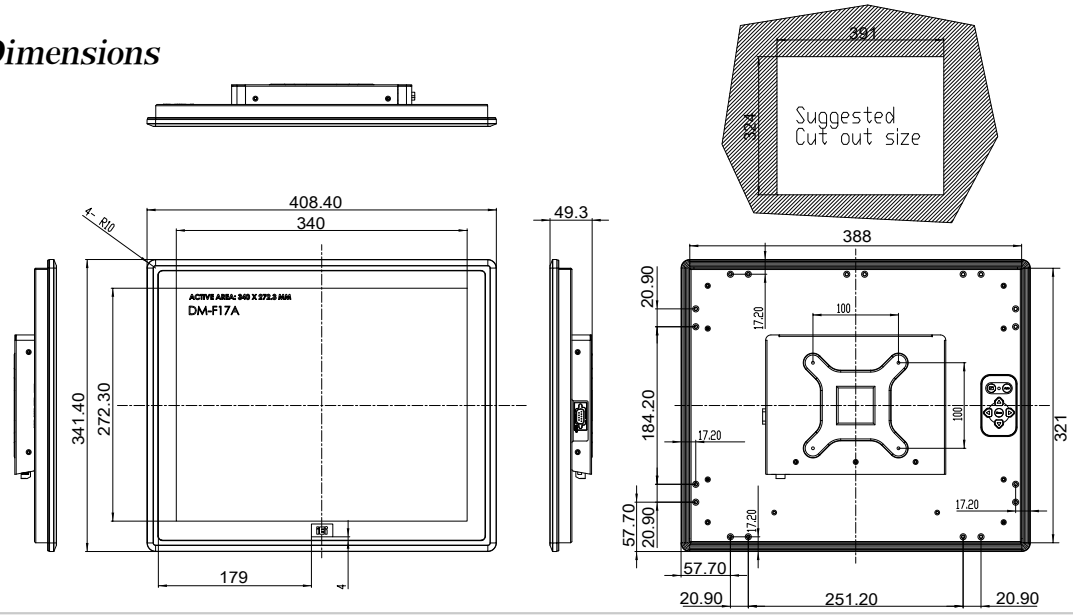

1

IEIMobile Solutions

2

Automation Panel Solutions

3

PACSmate Medical Solutions

4

Optional Peripherals

DM-F22A Dimensions

(Unit: mm)

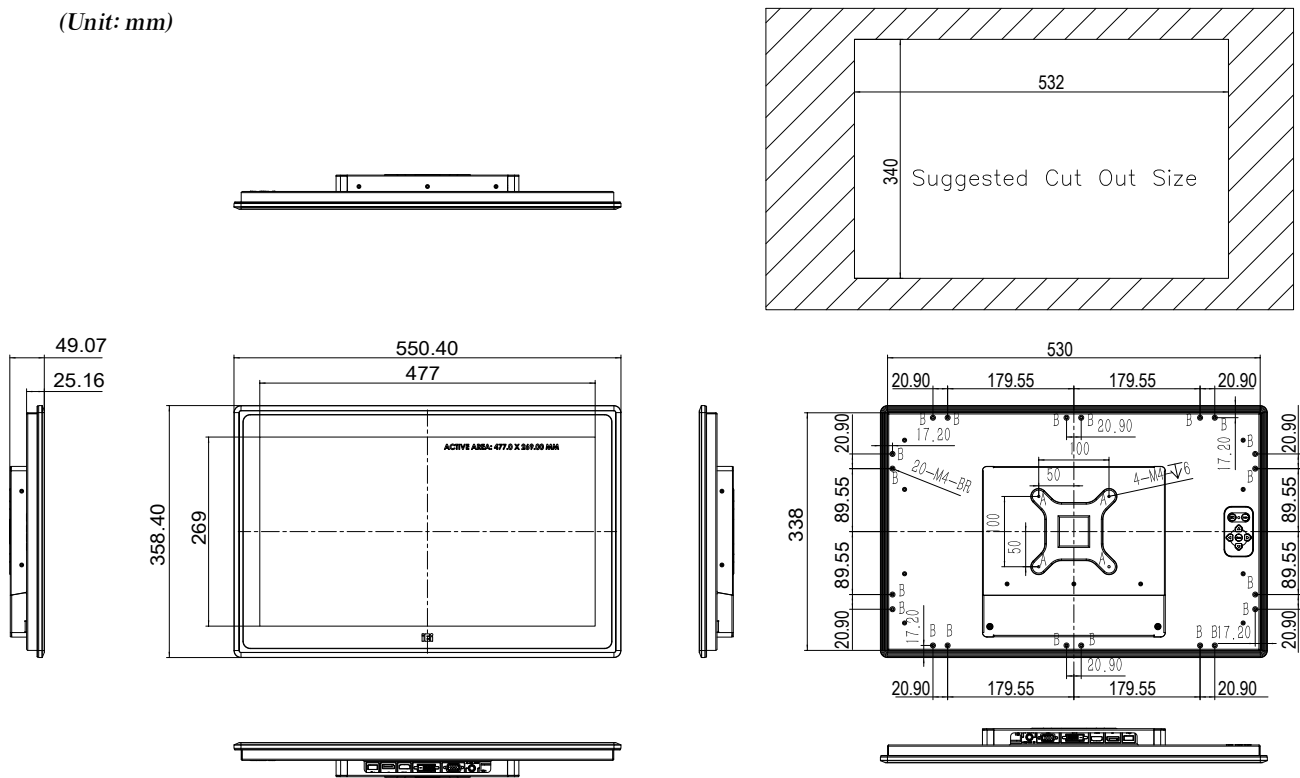

DM-F24A Dimensions

(Unit: mm)

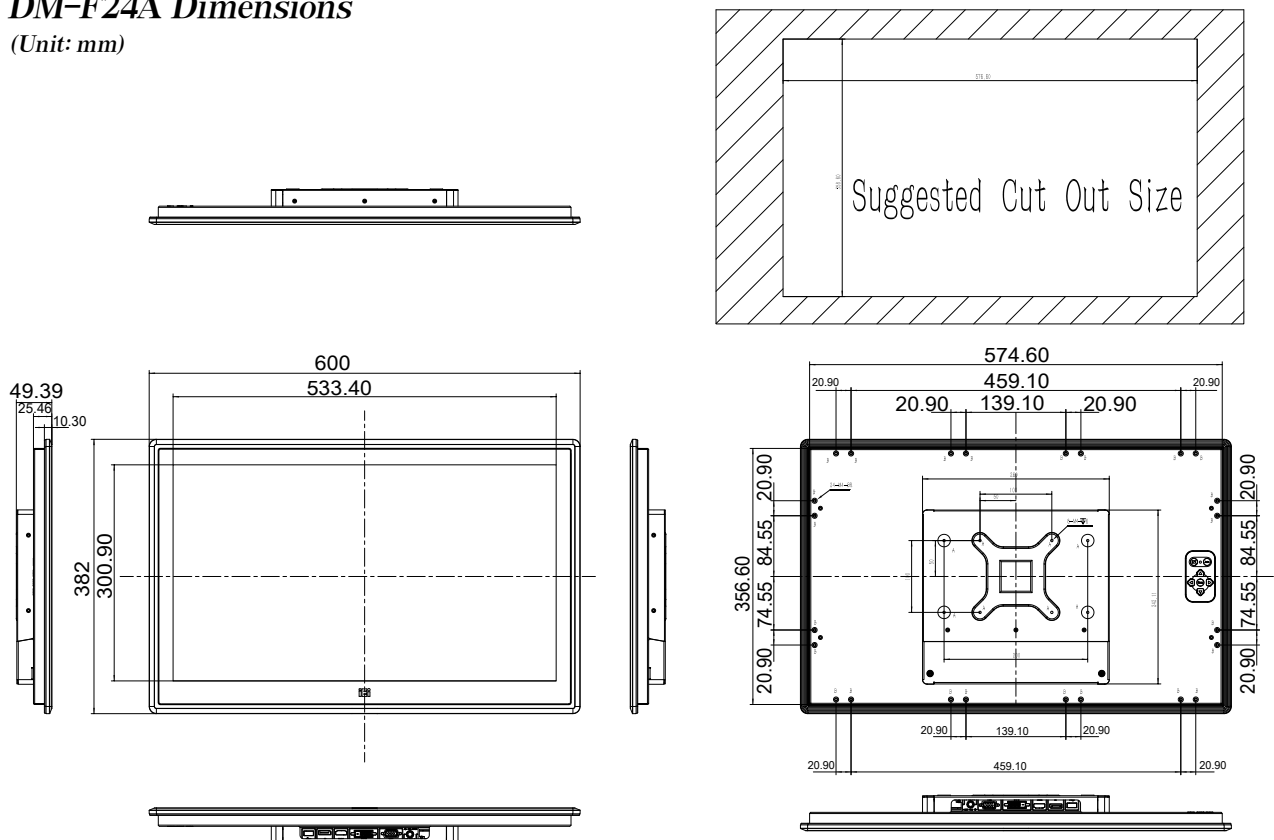

1

IEI Mobile Solutions

2

Automation Panel Solutions

3

PACSmate Medical Solutions

4

Optional Peripherals